

SAFIRE-70

7W DESIGNER SERIES LED TAPE LIGHT

Project _____

Location _____

Quote/ Ref # _____

The **SAFIRE-70**— a high efficiency, indoor tape light designed to illuminate your space with unparalleled efficiency and versatility. The Safire Series utilizes the most technologically advanced LEDs in the market. Using only the top binned LEDs with a macadam ellipse 1.5 step binning procedure, Core Lighting can deliver the most efficient LED strip, with a longer life, higher CRI and higher R9 values. Choose from multiple CCT options ranging from 2200K to 5000K.



SPECIFICATIONS

POWER CONSUMPTION	7W per Ft.
LEDS/ FT.	80 LEDES per Ft.
LUMEN OUTPUT	577 ~ 804 Lumens per Ft.
CRI	95+
COLOR TEMPERATURE	22K/ 24K/ 27K/ 30K/ 35K/ 40K/ 50K
DIMMING	MLV, ELV, 0-10V
MAXIMUM RUN LENGTH	15 Ft.
CUTTABLE	Every 1.31 in (33.3mm)
BINNING	1.5-Step MacAdam Elipse
OPERATING VOLTAGE	24V DC
OPERATING TEMPERATURE	-22°F (-30°C) to +122°F (+50°C)
BEAM ANGLE	120°
RATING	Indoor
CERTIFICATIONS	UL Listed, California TITLE JA8
LUMEN MAINTENANCE	50,000 Hrs.

FEATURES

- 24V DC
- Continuous Run up to 15 Ft.
- 95+ CRI
- Custom length available every 1.31 in.
- Dimmable
- UL Listed
- California TITLE 24 JA8 Compliant
- 7-Year Warranty*

* Only with compatible Core Lighting drivers



MODEL	COLOR TEMP	LED LENGTH	VOLTAGE	PROFILE
SFS-70	22K 2200K	100 100 Ft.	24 24V DC	² See Page 3 - 4 for compatible profiles.
	24K 2400K	1XX per Ft.		
	27K 2700K			
	30K 3000K			
	35K 3500K			
	40K 4000K			
	50K 5000K			
		*1 = Custom length per FT. (cuttable every 1.31")		* Custom color finishes require powder coating. Allow 7 days leads time.

SAFIRE-70

7W DESIGNER SERIES LED TAPE LIGHT

DIMENSIONS

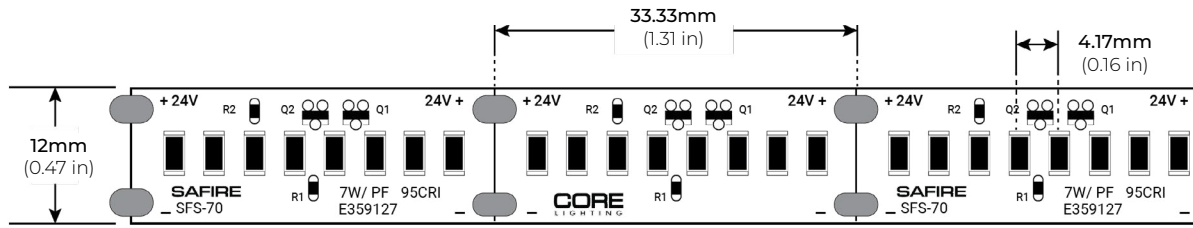

LUMENS

MODEL	WATT	CCT	Lumen/ FT	EFFICACY (lm/W)	CRI	R9	R13
SFS-70	7W	2200K	577	82	95+	85	98
		2400K	626	89	95+	91	99
		2700K	700	100	95+	94	98
		3000K	700	100	95+	95	99
		3500K	737	105	95+	94	98
		4000K	749	107	95+	92	98
		5000K	804	114	95+	96	99

SAFIRE-70

7W DESIGNER SERIES LED TAPE LIGHT

COMPATIBLE ALUMINUM PROFILES

SURFACE PROFILES

ALP-70

LENGTHS 49" | 84" | 98"
LENS Frosted
FINISH White | Black | Silver

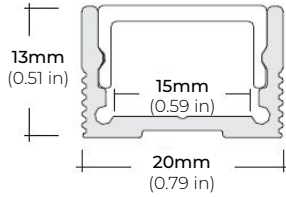

ALP-75C (CORNER)

LENGTHS 49" | 84" | 98"
LENS Frosted
FINISH Black | Silver

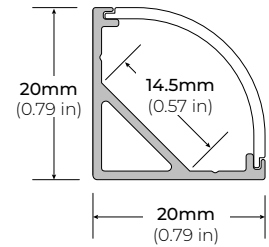

ALP-80

LENGTHS 49" | 98"
LENS Frosted
FINISH White | Black | Silver

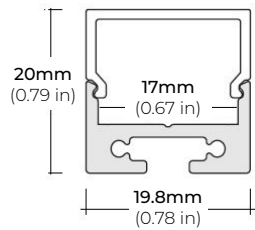

ALP-90

LENGTHS 48" | 96"
LENS Frosted
FINISH Silver

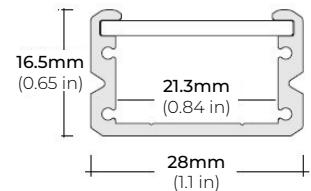

ALP-130

LENGTHS 49" | 84" | 98"
LENS Frosted
FINISH Silver | Black

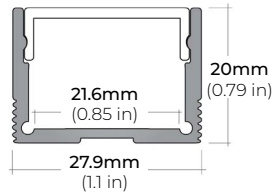

* For more compatible profiles, visit corelightingusa.com

RECESSED PROFILES

ALP-70R

LENGTHS 48" | 98"
LENS Frosted
FINISH Black | Silver

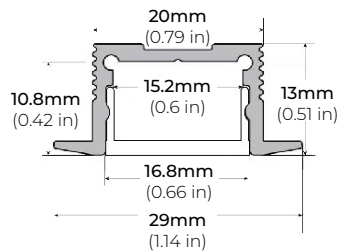

ALP-102R

LENGTHS 49" | 98"
LENS Frosted, Black, Asymmetric, Double Asymmetric
FINISH Silver

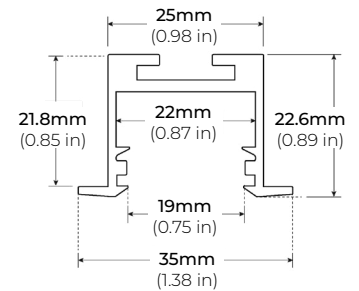

* For more compatible profiles, visit corelightingusa.com

SAFIRE-70

7W DESIGNER SERIES LED TAPE LIGHT

COMPATIBLE ALUMINUM PROFILES

TRIMLESS PROFILES

ALP-1300TL

LENGTHS 48" | 96"
LENS Clear, Frosted
FINISH White

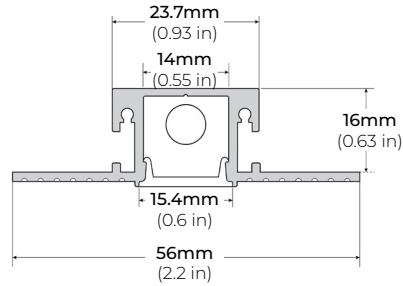

ALP-2300TL

LENGTHS 48" | 96"
LENS Frosted
FINISH White

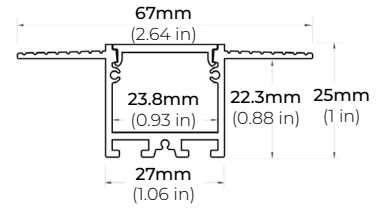

ALP-2400TL

LENGTHS 48" | 96"
LENS Clear, Frosted
FINISH White

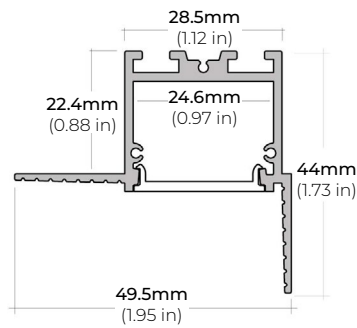

ALP-2700TL

LENGTHS 48" | 96"
LENS Frosted
FINISH White

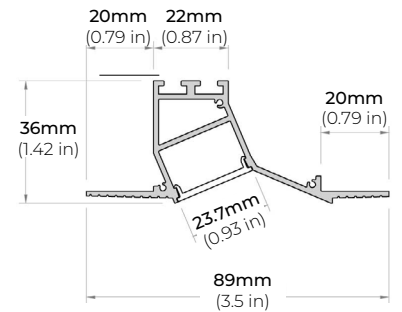

* For more compatible profiles, visit corelightingusa.com

SUSPENDED PROFILES

ALP-80

LENGTHS 49" | 98"
LENS Frosted
FINISH White | Black | Silver

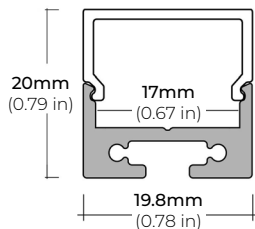

ALP-85

LENGTHS 48" | 98"
LENS Frosted
FINISH Silver

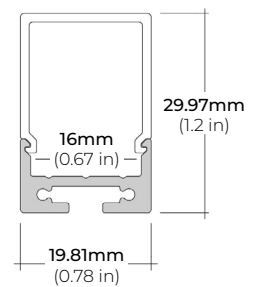

* For more compatible profiles, visit corelightingusa.com

SAFIRE-70

7W DESIGNER SERIES LED TAPE LIGHT

COMPATIBLE TRANSFORMERS

PSDL SERIES TRIAC DIMMABLE

PSDL-30W-24V	CLASS 2	6.5" X 3.63" X 1.03"
PSDL-60W-24V	CLASS 2	7.4" X 3.63" X 1.03"
PSDL-96W-24V	CLASS 2	8.67" X 3.67 X 1.62"
PSDL-150W-24V		8.67" X 3.67" X 1.62"
PSDL-192W-24V	CLASS 2	10.25" X 4.06" X 1.82"
PSDL-200W-24V		10.25" X 4.06" X 1.82"
PSDL-288W-24V	CLASS 2	10.25" X 4.06" X 1.82"
PSDL-300W-24V		10.25" X 4.06" X 1.82"

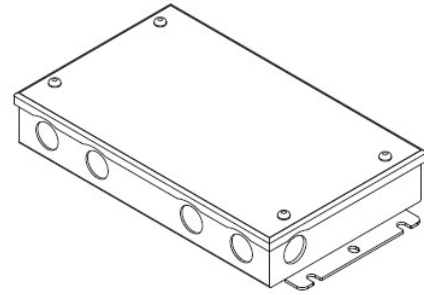

PSDH SERIES HIGH PERFORMANCE MAGNETIC LOW VOLTAGE (MLV)

PSDH-48W-24V	CLASS 2	11.25" X 3.37" X 3.25"
PSDH-96W-24V	CLASS 2	11.25" X 3.37" X 3.25"

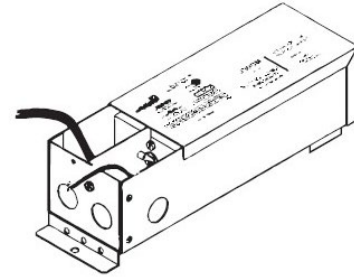

PSRX SERIES 4-IN-1 DIMMING DRIVER

PSRX-30W-24V	CLASS 2	6.5" X 3.72" X 1.57"
PSRX-60W-24V	CLASS 2	7.4" X 3.72" X 1.57"
PSRX-96W-24V	CLASS 2	8.66" X 3.72" X 1.57"
PSRX-150W-24V		10.24" X 4.13" X 1.77"
PSRX-192W-24V	CLASS 2	11" X 4" X 1.82"
PSRX-200W-24V		10.24" X 4.13" X 1.77"
PSRX-288W-24V	CLASS 2	11.85" X 4.25" X 1.82"
PSRX-300W-24V		10.94" X 4.33" X 1.77"

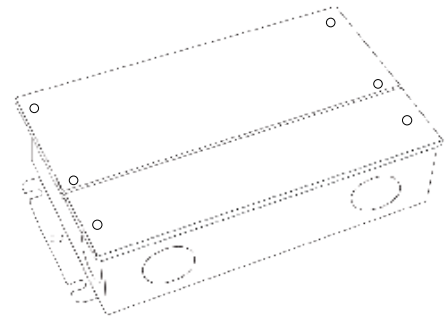

PSVT SERIES 0-10V DIMMING DRIVER

PSVT-60W-24V	CLASS 2	7.4" X 3.72" X 1.57"
PSVT-96W-24V	CLASS 2	8.66" X 3.72" X 1.57"
PSVT-200W-24V		10.24" X 4.13" X 1.77"
PSVT-288W-24V	CLASS 2	11.85" X 4.25" X 1.81"
PSVT-300W-24V		10.94" X 4.33" X 1.77"

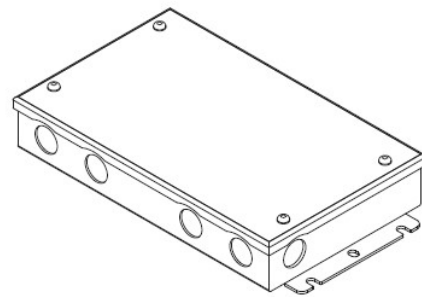

SAFIRE-70

7W DESIGNER SERIES LED TAPE LIGHT

COMPATIBLE TRANSFORMERS

PSDE SERIES

0-10V DIMMING W/ JUNCTION BOX

PSDE-60W-24V-010-JB	CLASS 2	12.1" X 2.36" X 1.4"
PSDE-96W-24V-010-JB	CLASS 2	12.1" X 2.36" X 1.4"

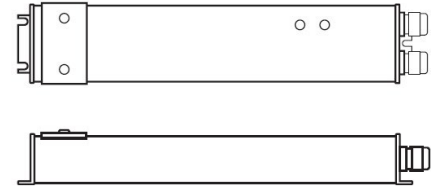

LUTRON 1%

2 OR 3-WIRE DIMMING

LTEA4U1UKL-CV240	CLASS 2	4.89" X 4" X 2.62"
L3DA4U1UKL-CV240	CLASS 2	4.89" X 4" X 2.62"

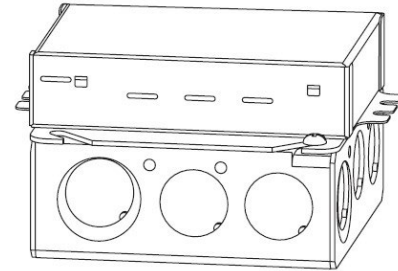

LUTRON 1%

PSDE-96W-24V-ECO	CLASS 2	10.5" X 3.0" X 2.0"
------------------	---------	---------------------

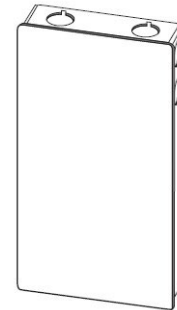

COMPATIBLE NON-DIMMING DRIVERS

PSHK SERIES

NON-DIMMING CONSTANT VOLTAGE WITH JUNCTION BOX

PSHK-30W-24V	CLASS 2	6.5" X 3.6" X 1.02"
PSHK-60W-24V	CLASS 2	7.4" X 3.62" X 1.02"
PSHK-96W-24V	CLASS 2	8.66" X 3.66" X 1.61"
PSHK-150W-24V		10.24" X 4.06" X 1.81"
PSHK-200W-24V		10.24" X 4.06" X 1.81"
PSHK-288W-24V	CLASS 2	11.85" X 4.25" X 1.82"
PSHK-300W-24V		10.24" X 4.25" X 1.81"

