

LSXT-250

2.2W LONG RUN OUTDOOR FLEXIBLE LED STRIP

Project _____

Location _____

Quote/ Ref # _____

The **LSXT-250** series is a dimmable, flexible LED strip capable of delivering up to 235 Lumens of light output per foot. It is cuttable every 3.92" and can reach a maximum of 64 Ft. in a single, continuous run. This innovative strip delivers consistent brightness with superior color rendering in a very efficient package.

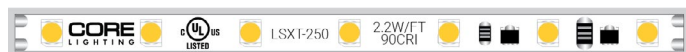

SPECIFICATIONS

INPUT VOLTAGE	24V DC
POWER CONSUMPTION	2.2W/Ft.
NO. OF LEDS	21 LEDs per Ft.
LUMEN OUTPUT	235 Lumens per foot (30K)
CRI	95+
COLOR TEMPERATURE	27K/ 30K/ 40K
DIMMING	MLV, ELV, 0-10V and TRIAC
MAXIMUM RUN LENGTH	64 Ft.
CUTTABLE	Every 3.92 in (99.5mm)
OPERATING TEMPERATURE	-40°F (-40°C) ~ +140°F (+60°C)
STORAGE TEMPERATURE	-22°F(-30°C)~+176°F(+80°C)
BEAM ANGLE	120°
IP RATING	IP65 wet location (outdoor)
CERTIFICATIONS	UL Listed, TITLE 24 JA8
LUMEN MAINTENANCE	50,000 Hrs

FEATURES

- 2.2W/Ft.
- 24V Low-Voltage LED Strip
- Suitable for accent or ambient lighting
- Multiple CCT options available
- Superior COLOR RENDERING INDEX (CRI)
- Dimmable with CORE Lighting Dimming Drivers
- UL Listed

*Approved for closet / storage space installation per NEC 410.16(A)(3) and 410.16(C)(5)



MODEL	COLOR TEMP	LENGTH	VOLTAGE
LSXT250	27K 2700K	100 100 Ft.	24 24V DC
	30K 3000K	325 325 Ft.	
	40K 4000K	1'XX Per Ft.	
		*1 = Custom length per FT. (Cuttable every 3.92")	

LSXT-250

2.2W LONG RUN OUTDOOR FLEXIBLE LED STRIP

DIMENSIONS

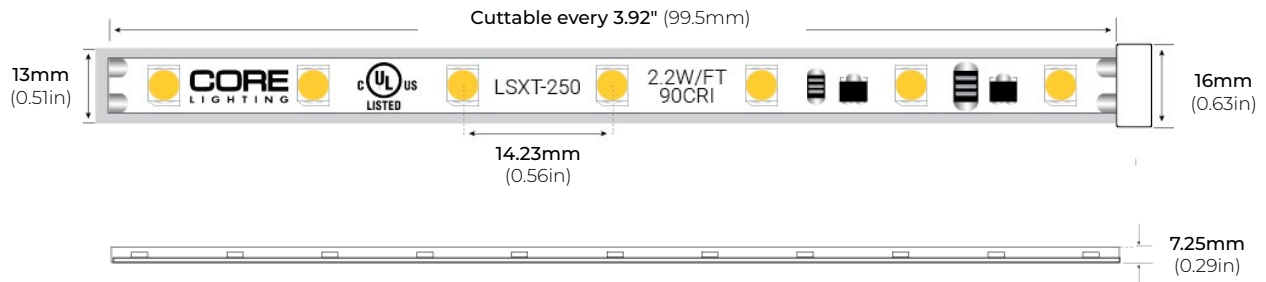

COMPATIBLE ACCESSORIES

LSXT-EC
END CAP

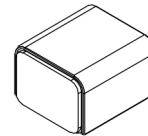

ALU-CN (CORNER)

LENGTHS 39" | 78" | 84" | 96"
LENS Clear, Frosted
FINISH Black | Silver

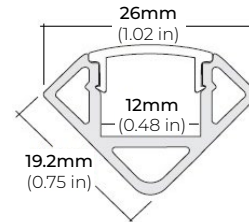

ALUMINUM CHANNEL

LSXT-AC2
2" ALUMINUM CHANNEL

LSXT-AC48
48" ALUMINUM CHANNEL

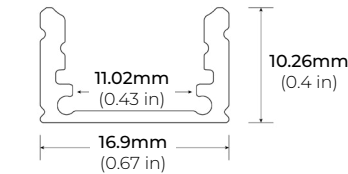

EXTENSION COUPLING

LSXT-EX3 3" LINK CABLE
LSXT-EX8 8" LINK CABLE
LSXT-EX24 24" LINK CABLE

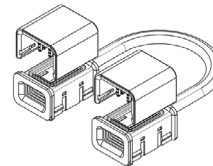

HARDWIRE CONNECTOR

LSXT-HW24 24" HARDWIRE CONNECTOR
LSXT-HW60 60" HARDWIRE CONNECTOR
LSXT-HW120 120" HARDWIRE CONNECTOR

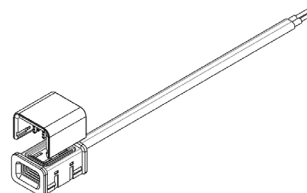

LSXT-250

2.2W LONG RUN OUTDOOR FLEXIBLE LED STRIP

COMPATIBLE TRANSFORMERS

PSDL SERIES TRIAC DIMMABLE

PSDL-30W-24V	CLASS 2	6.5" X 3.63" X 1.03"
PSDL-60W-24V	CLASS 2	7.4" X 3.63" X 1.03"
PSDL-96W-24V	CLASS 2	8.67" X 3.67 X 1.62"
PSDL-150W-24V		8.67" X 3.67" X 1.62"
PSDL-192W-24V	CLASS 2	10.25" X 4.06" X 1.82"
PSDL-200W-24V		10.25" X 4.06" X 1.82"
PSDL-288W-24V	CLASS 2	10.25" X 4.06" X 1.82"
PSDL-300W-24V		10.25" X 4.06" X 1.82"

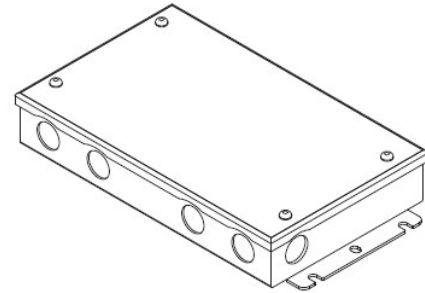

PSDH SERIES HIGH PERFORMANCE MAGNETIC LOW VOLTAGE (MLV)

PSDH-48W-24V	CLASS 2	11.25" X 3.37" X 3.25"
PSDH-96W-24V	CLASS 2	11.25" X 3.37" X 3.25"

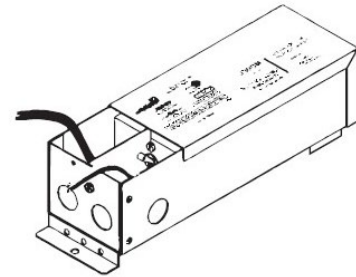

PSRX SERIES 4-IN-1 DIMMING DRIVER

PSRX-30W-24V	CLASS 2	6.5" X 3.72" X 1.57"
PSRX-60W-24V	CLASS 2	7.4" X 3.72" X 1.57"
PSRX-96W-24V	CLASS 2	8.66" X 3.72" X 1.57"
PSRX-150W-24V		10.24" X 4.13" X 1.77"
PSRX-192W-24V	CLASS 2	11" X 4" X 1.82"
PSRX-200W-24V		10.24" X 4.13" X 1.77"
PSRX-288W-24V	CLASS 2	11.85" X 4.25" X 1.82"
PSRX-300W-24V		10.94" X 4.33" X 1.77"

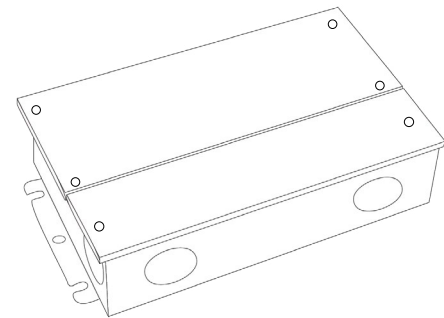

PSVT SERIES 0-10V DIMMING DRIVER

PSVT-60W-24V	CLASS 2	7.4" X 3.72" X 1.57"
PSVT-96W-24V	CLASS 2	8.66" X 3.72" X 1.57"
PSVT-200W-24V		10.24" X 4.13" X 1.77"
PSVT-288W-24V	CLASS 2	11.85" X 4.25" X 1.81"
PSVT-300W-24V		10.94" X 4.33" X 1.77"

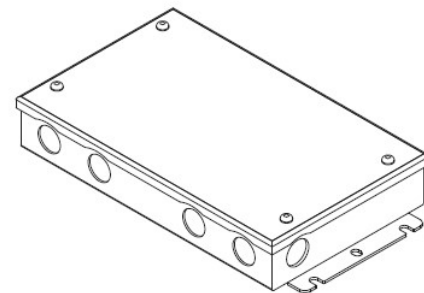

LSXT-250

2.2W LONG RUN OUTDOOR FLEXIBLE LED STRIP

COMPATIBLE TRANSFORMERS

PSDE SERIES
0-10V DIMMING W/ JUNCTION BOX

PSDE-60W-24V-010-JB CLASS 2 12.1" X 2.36" X 1.4"
PSDE-96W-24V-010-JB CLASS 2 12.1" X 2.36" X 1.4"

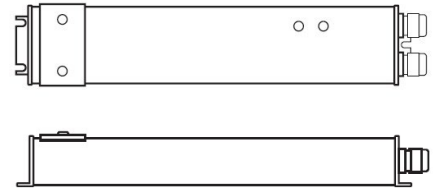

LUTRON 1%
3-WIRE DIMMING

L3DA4U1UKL-CV240 CLASS 2 4.89" X 4" X 2.62"

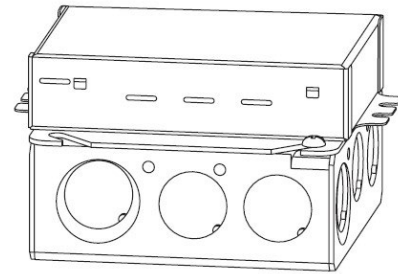

LUTRON 1%
3-WIRE DIMMING

PSDE-96W-24V-ECO CLASS 2 10.5" X 3.0" X 2.0"

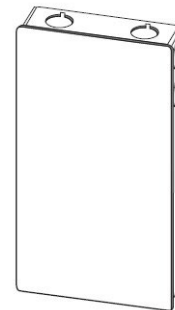

COMPATIBLE NON-DIMMING DRIVERS

PSHK SERIES
NON-DIMMING CONSTANT VOLTAGE WITH JUNCTION BOX

PSHK-30W-24V CLASS 2 6.5" X 3.6" X 1.02"
PSHK-60W-24V CLASS 2 7.4" X 3.62" X 1.02"
PSHK-96W-24V CLASS 2 8.66" X 3.66" X 1.61"
PSHK-150W-24V 10.24" X 4.06" X 1.81"
PSHK-200W-24V 10.24" X 4.06" X 1.81"
PSHK-288W-24V CLASS 2 11.85" X 4.25" X 1.82"
PSHK-300W-24V 10.24" X 4.25" X 1.81"

