

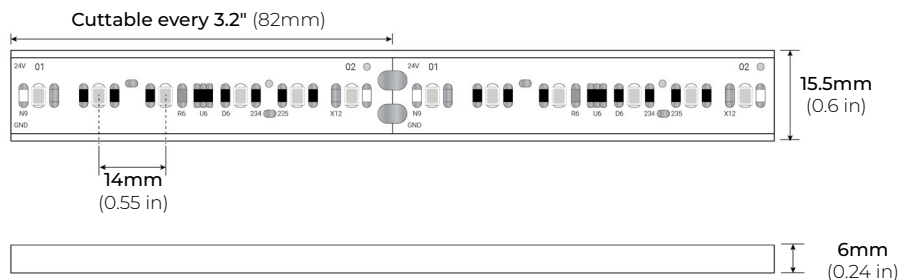

# LSRN-50

## 4.4W IP65 OUTDOOR LED STRIP

### DIMENSIONS



### COMPATIBLE ACCESSORIES

**LSRN50-AC2**  
2" ALUMINUM CHANNEL

**LSRN50-AC39**  
39" ALUMINUM CHANNEL

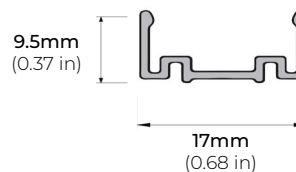

### HARDWIRE CONNECTOR KIT

**LSRN-HW36**  
36" CONNECTOR

**LSRN-HW120**  
120" CONNECTOR

**LSRN-HW200**  
200" CONNECTOR

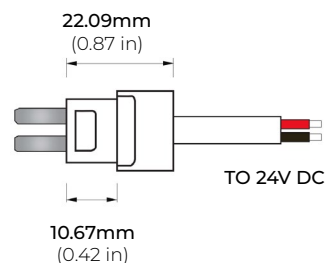

\*Includes 1 Connector, 1 PC cover, 1 Anti-skidding clip, and 1 Heat-shrink tube.

### INTERLINK CABLE KIT

**LSRN-EX2**  
2" LINK CABLE

**LSRN-EX6**  
6" LINK CABLE

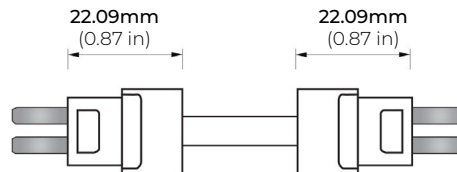

\*Includes 1 Interlink cable, 2 PC covers, 2 Anti-skidding clips, and 2 Heat-shrink tubes.

### SEAMLESS COUPLING KIT

**LSRN-MC**  
MINI COUPLING

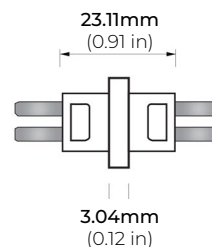

\*Includes 1 Coupling, 2 PC covers, 2 Anti-skidding clips, and 1 Heat-shrink tube.

# LSRN-50

## 4.4W IP65 OUTDOOR LED STRIP

### COMPATIBLE TRANSFORMERS

#### PSDL SERIES TRIAC DIMMABLE

PSDL-30W-24V	CLASS 2	6.5" X 3.63" X 1.03"
PSDL-60W-24V	CLASS 2	7.4" X 3.63" X 1.03"
PSDL-96W-24V	CLASS 2	8.67" X 3.67" X 1.62"
PSDL-150W-24V		8.67" X 3.67" X 1.62"
PSDL-192W-24V	CLASS 2	10.25" X 4.06" X 1.82"
PSDL-200W-24V		10.25" X 4.06" X 1.82"
PSDL-288W-24V	CLASS 2	10.25" X 4.06" X 1.82"
PSDL-300W-24V		10.25" X 4.06" X 1.82"

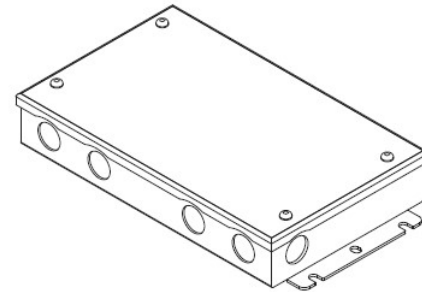

#### PSDH SERIES HIGH PERFORMANCE MAGNETIC LOW VOLTAGE (MLV)

PSDH-48W-24V	CLASS 2	11.25" X 3.38" X 3.38"
PSDH-96W-24V	CLASS 2	11.25" X 3.38" X 3.37"

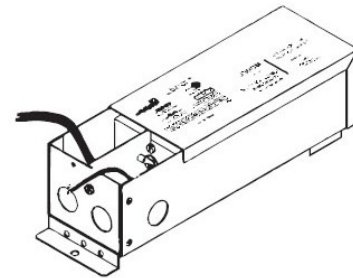

#### PSRX SERIES 4-IN-1 DIMMING DRIVER W/ JUNCTION BOX

PSRX-30W-24V-UNV	CLASS 2	6.5" X 3.7" X 1.57"
PSRX-60W-24V-UNV	CLASS 2	7.4" X 3.72" X 1.57"
PSRX-96W-24V-UNV	CLASS 2	8.66" X 3.72" X 1.57"
PSRX-150W-24V-UNV		10.24" X 4.13" X 1.77"
PSRX-200W-24V-UNV		10.24" X 4.13" X 1.77"
PSRX-300W-24V-UNV		10.94" X 4.33" X 1.77"

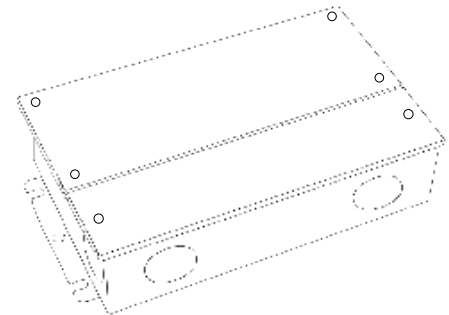

#### PSVT SERIES 0-10V DIMMING DRIVER

PSVT-60W-24V	CLASS 2	7.4" X 3.72" X 1.57"
PSVT-96W-24V	CLASS 2	8.66" X 3.72" X 1.57"
PSVT-200W-24V		10.24" X 4.13" X 1.77"
PSVT-288W-24V	CLASS 2	11.85" X 4.25" X 1.81"
PSVT-300W-24V		10.94" X 4.33" X 1.77"

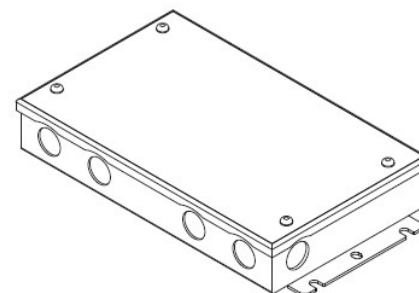

# LSRN-50

## 4.4W IP65 OUTDOOR LED STRIP

### COMPATIBLE TRANSFORMERS

#### PSDE SERIES

0-10V DIMMING W/ JUNCTION BOX

PSDE-60W-24V-010-JB	CLASS 2	12.1" X 2.36" X 1.4"
PSDE-96W-24V-010-JB	CLASS 2	12.1" X 2.36" X 1.4"

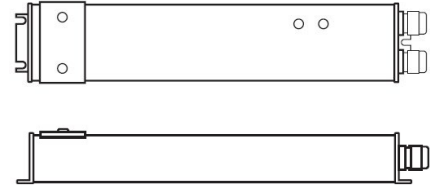

#### LUTRON 1% 3-WIRE DIMMING

L3DA4JTUKL-CV240	CLASS 2	4.89" X 4" X 2.62"
------------------	---------	--------------------

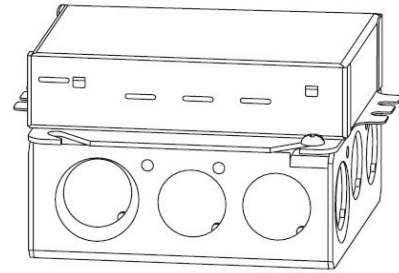

#### LUTRON 1% 3-WIRE DIMMING

PSDE-96W-24V-ECO	CLASS 2	10.5" X 3.0" X 2.0"
------------------	---------	---------------------

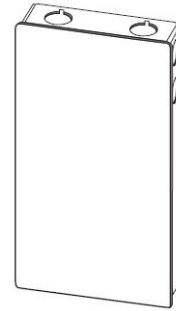

#### PSHK SERIES

NON-DIMMING CONSTANT VOLTAGE WITH JUNCTION BOX

PSHK-30W-24V	CLASS 2	6.5" X 3.6" X 1.02"
PSHK-60W-24V	CLASS 2	7.4" X 3.62" X 1.02"
PSHK-96W-24V	CLASS 2	8.66" X 3.66" X 1.61"
PSHK-150W-24V		10.24" X 4.06" X 1.81"
PSHK-200W-24V		10.24" X 4.06" X 1.81"
PSHK-288W-24V	CLASS 2	11.85" X 4.25" X 1.82"
PSHK-300W-24V		10.24" X 4.25" X 1.81"

