

# LSRN-40

## 3.8W IP65/IP67 OUTDOOR LED STRIP

Project \_\_\_\_\_  
Location \_\_\_\_\_  
Quote/ Ref # \_\_\_\_\_

The **LSRN series** outdoor LED strip is a high-performance, water resistant light source designed for all-weather and harsh environments. It is manufactured with a patented epoxy PVC material that makes it resistant to salt water, chlorine, rain and humidity. Aside from its ability to withstand harsh environments, the LSRN series also does a great job of giving a space a much needed visual upgrade by providing either softer, warm ambient glows or aggressive, brighter tones.



### SPECIFICATIONS

INPUT VOLTAGE	24V DC Constant Voltage
POWER CONSUMPTION	3.8W per ft.
LUMEN OUTPUT	140 Lumens per Ft.
CRI	90
COLOR TEMP	27K / 30K / 40K
DIMMING	MLV, ELV, 0-10 and TRIAC
MAXIMUM RUN LENGTH	32 Ft.
CUTTING LENGTH	Every 3.86" (98mm)
STORAGE TEMPERATURE	-4°F ~ 176°F (-20°C ~ 80°C)
OPERATING TEMPERATURE	-4°F ~ 122°F (-20°C ~ 50°C)
BEAM ANGLE	120°
IP RATING	IP65/IP67
CERTIFICATIONS	UL Listed
LUMEN MAINTENANCE	50,000 Hours

### FEATURES

- Integrated frosted diffuser
- High-performance, high-quality manufacturing
- IP65/IP67 outdoor (wet) rated, water resistant
- Multiple CCT options available
- Dimmable
- Environment friendly, energy efficient light source



MODEL	COLOR TEMP	LENGTH	VOLTAGE	IP RATING	POWER FEED	FEED LENGTH		
LSRN40	<b>27K</b> 2700K	<b>16</b> 16.4 Ft.	<b>24</b> 24V	<b>IP65</b> Damp	<b>BF</b> Bottom Feed	<b>HW3</b> 3 Ft. Power Feed		
	<b>30K</b> 3000K	<b>32</b> 32 Ft.			<b>IP67</b> Wet		<b>SFL</b> Side Feed Left	<b>HW10</b> 10 Ft. Power Feed
	<b>40K</b> 4000K	<b>1PF</b> Per Ft.					<b>SFR</b> Side Feed Right	
					<b>EF</b> End Feed			

\*1 = Custom length per FT. (Cutttable every 3.86")

# LSRN-40

## 3.8W IP65/IP67 OUTDOOR LED STRIP

### DIMENSIONS

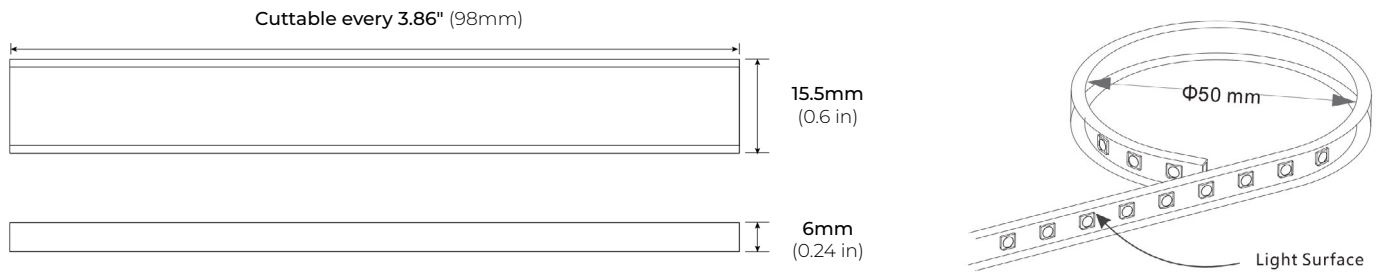

### COMPATIBLE ACCESSORIES

LSRN40-AC2  
2" ALUMINUM CHANNEL

LSRN40-AC39  
39" ALUMINUM CHANNEL

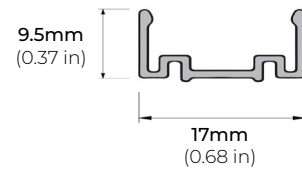

# LSRN-40

## 3.8W IP65/IP67 OUTDOOR LED STRIP

### IP65/IP67 POWER FEED

BF  
BOTTOM FEED

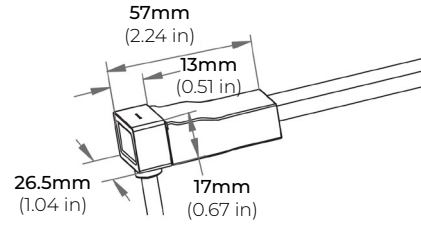

SFL  
SIDE FEED LEFT

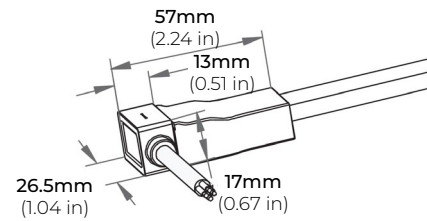

SFR  
SIDE FEED RIGHT

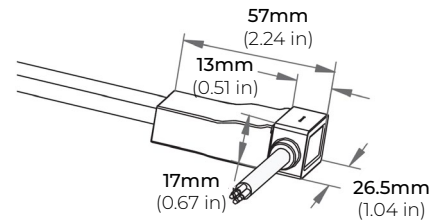

EF  
END FEED

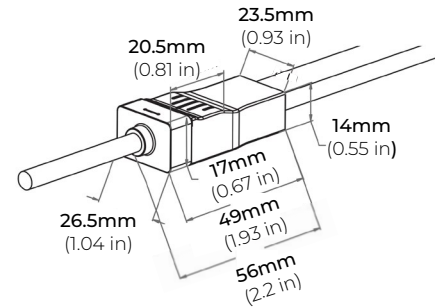

END CAP

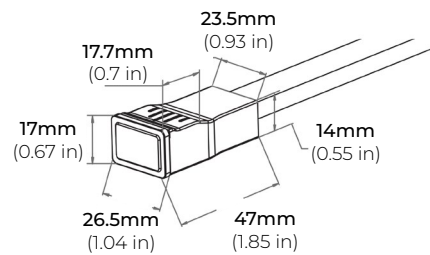

# LSRN-40

## 3.8W IP65/IP67 OUTDOOR LED STRIP

### COMPATIBLE TRANSFORMERS

#### PSDL SERIES TRIAC DIMMABLE

PSDL-30W-24V	CLASS 2	6.5" X 3.63" X 1.03"
PSDL-60W-24V	CLASS 2	7.4" X 3.63" X 1.03"
PSDL-96W-24V	CLASS 2	8.67" X 3.67" X 1.62"
PSDL-150W-24V		8.67" X 3.67" X 1.62"
PSDL-192W-24V	CLASS 2	10.25" X 4.06" X 1.82"
PSDL-200W-24V		10.25" X 4.06" X 1.82"
PSDL-288W-24V	CLASS 2	10.25" X 4.06" X 1.82"
PSDL-300W-24V		10.25" X 4.06" X 1.82"

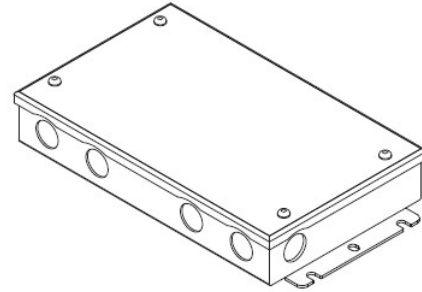

#### PSDH SERIES HIGH PERFORMANCE MAGNETIC LOW VOLTAGE (MLV)

PSDH-48W-24V	CLASS 2	11.25" X 3.38" X 3.38"
PSDH-96W-24V	CLASS 2	11.25" X 3.38" X 3.37"

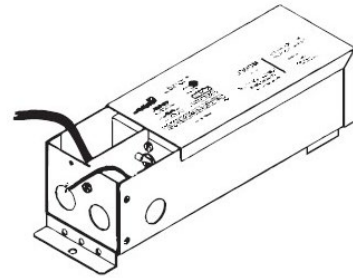

#### PSRX SERIES 4-IN-1 DIMMING DRIVER W/ JUNCTION BOX

PSRX-30W-24V-UNV	CLASS 2	6.5" X 3.7" X 1.57"
PSRX-60W-24V-UNV	CLASS 2	7.4" X 3.72" X 1.57"
PSRX-96W-24V-UNV	CLASS 2	8.66" X 3.72" X 1.57"
PSRX-150W-24V-UNV		10.24" X 4.13" X 1.77"
PSRX-200W-24V-UNV		10.24" X 4.13" X 1.77"
PSRX-300W-24V-UNV		10.94" X 4.33" X 1.77"

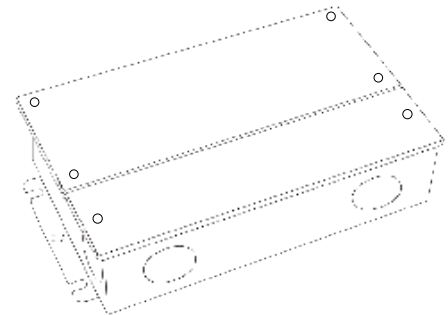

#### PSVT SERIES 0-10V DIMMING DRIVER

PSVT-60W-24V	CLASS 2	7.4" X 3.72" X 1.57"
PSVT-96W-24V	CLASS 2	8.66" X 3.72" X 1.57"
PSVT-200W-24V		10.24" X 4.13" X 1.77"
PSVT-288W-24V	CLASS 2	11.85" X 4.25" X 1.81"
PSVT-300W-24V		10.94" X 4.33" X 1.77"

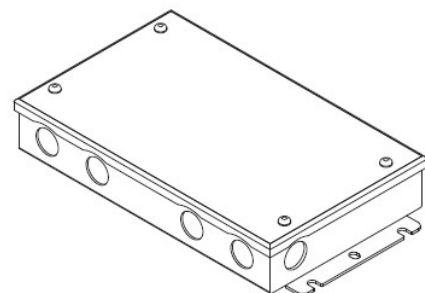

# LSRN-40

## 3.8W IP65/IP67 OUTDOOR LED STRIP

### COMPATIBLE TRANSFORMERS

---

#### PSDE SERIES

0-10V DIMMING W/ JUNCTION BOX

PSDE-60W-24V-010-JB	CLASS 2	12.1" X 2.36" X 1.4"
PSDE-96W-24V-010-JB	CLASS 2	12.1" X 2.36" X 1.4"

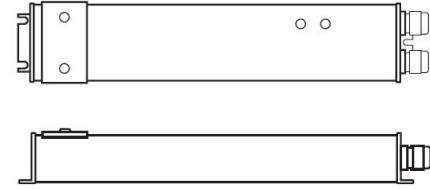

#### LUTRON 1% 3-WIRE DIMMING

L3DA4JTUJL-CV240	CLASS 2	4.89" X 4" X 2.62"
------------------	---------	--------------------

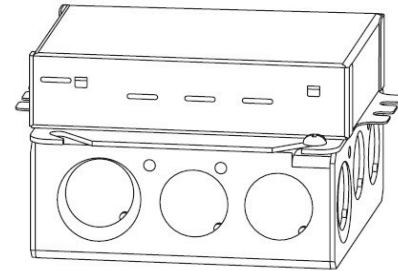

#### LUTRON 1% 3-WIRE DIMMING

PSDE-96W-24V-ECO	CLASS 2	10.5" X 3.0" X 2.0"
------------------	---------	---------------------

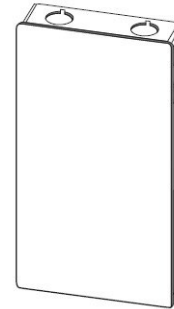

#### PSHK SERIES

NON-DIMMING CONSTANT VOLTAGE WITH JUNCTION BOX

PSHK-30W-24V	CLASS 2	6.5" X 3.6" X 1.02"
PSHK-60W-24V	CLASS 2	7.4" X 3.62" X 1.02"
PSHK-96W-24V	CLASS 2	8.66" X 3.66" X 1.61"
PSHK-150W-24V		10.24" X 4.06" X 1.81"
PSHK-200W-24V		10.24" X 4.06" X 1.81"
PSHK-288W-24V	CLASS 2	11.85" X 4.25" X 1.82"
PSHK-300W-24V		10.24" X 4.25" X 1.81"

