

LSRN-20N

2.2W NAUTICAL OUTDOOR FLEXIBLE LED STRIP

Project _____
Location _____
Quote/ Ref # _____

LSRN SERIES is a high performance, water-resistant LED strip designed for all-weather and harsh environments. It is manufactured with a patented epoxy PVC material that makes the LED strip resistant to saltwater, chlorine, rain, and humidity. The LSRN Series is the perfect solution for lighting areas where exposure to extreme elements cannot be avoided.

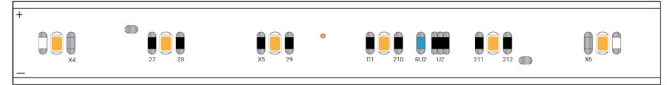

SPECIFICATIONS

INPUT VOLTAGE	24V DC
POWER CONSUMPTION	2.2W/Ft.
NO. OF LEDS	19 LEDs per Ft.
LUMEN OUTPUT	275 Lm/Ft. (30K)
CRI	90+
COLOR TEMPERATURE	27K / 30K / 40K / RGB
DIMMING	Compatible with CL Dimmers
MAXIMUM RUN LENGTH	32.8 Ft.
FIELD CUTTABLE	NO
BINNING	1.5 Step Macadam Elipse
OPERATING TEMPERATURE	-40°F (-40°C) ~ 122°F (60°C)
BEAM ANGLE	120°
IP RATING	IP65 wet location (outdoor)
CERTIFICATIONS	ETL / UL listed
LUMEN MAINTENANCE	50,000 Hrs

FEATURES

- 2.2W per Ft.
- 19 LEDs per Ft.
- Water resistant
- Suitable for WET / OUTDOOR applications
- Multiple CCT options available
- Superior COLOR RENDERING INDEX (CRI)
- UL Listed



MODEL	COLOR TEMP	LENGTH	VOLTAGE
LSRN20N	27K 2700K	16 16.4 Ft.	24 24V DC
	30K 3000K	32 32 Ft.	
	40K 4000K	1'PF Per Ft.	
	RGB RGB		

*1 = Custom length per FT.
(Cuttable every 6.5")

LSRN-20N

2.2W NAUTICAL OUTDOOR FLEXIBLE LED STRIP

DIMENSIONS

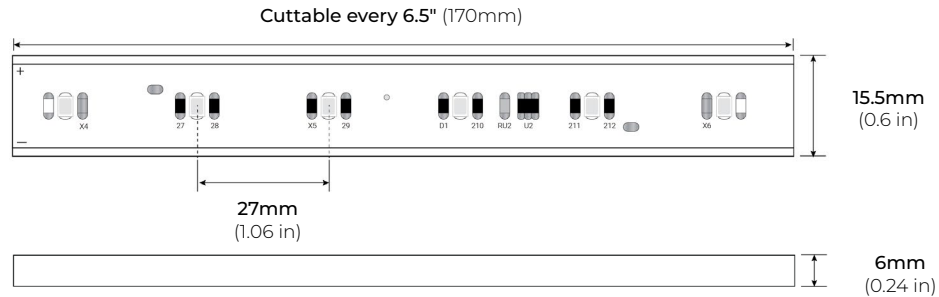

COMPATIBLE ACCESSORIES

LSRN-AC2
2" ALUMINUM CHANNEL

LSRN-AC39
39" ALUMINUM CHANNEL

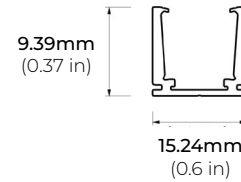

HARDWIRE CONNECTOR KIT

LSRN-HW36
36" CONNECTOR

LSRN-HW120
120" CONNECTOR

LSRN-HW200
200" CONNECTOR

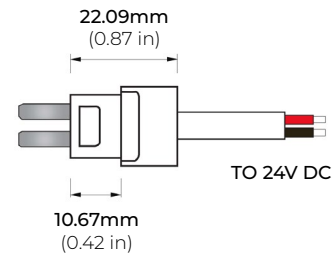

*Includes 1 Connector, 1 PC cover, 1 Anti-skidding clip, and 1 Heat-shrink tube.

INTERLINK CABLE KIT

LSRN-EX2
2" LINK CABLE

LSRN-EX6
6" LINK CABLE

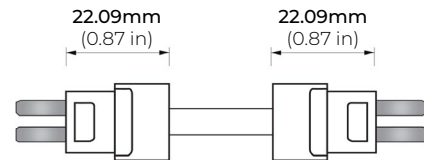

*Includes 1 Interlink cable, 2 PC covers, 2 Anti-skidding clips, and 2 Heat-shrink tubes.

SEAMLESS COUPLING KIT

LSRN-MC
MINI COUPLING

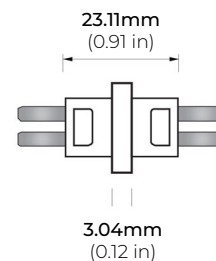

*Includes 1 Coupling, 2 PC covers, 2 Anti-skidding clips, and 1 Heat-shrink tube.

LSRN-20N

2.2W NAUTICAL OUTDOOR FLEXIBLE LED STRIP

COMPATIBLE TRANSFORMERS

PSDL SERIES TRIAC DIMMABLE

PSDL-30W-24V	CLASS 2	6.5" X 3.63" X 1.03"
PSDL-60W-24V	CLASS 2	7.4" X 3.63" X 1.03"
PSDL-96W-24V	CLASS 2	8.67" X 3.67 X 1.62"
PSDL-150W-24V		8.67" X 3.67" X 1.62"
PSDL-192W-24V	CLASS 2	10.25" X 4.06" X 1.82"
PSDL-200W-24V		10.25" X 4.06" X 1.82"
PSDL-288W-24V	CLASS 2	10.25" X 4.06" X 1.82"
PSDL-300W-24V		10.25" X 4.06" X 1.82"

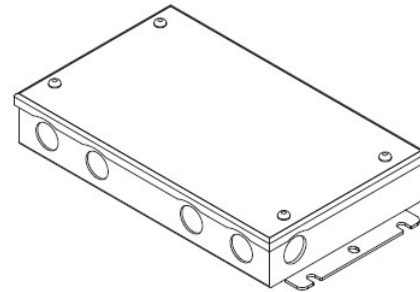

PSDH SERIES HIGH PERFORMANCE MAGNETIC LOW VOLTAGE (MLV)

PSDH-48W-24V	CLASS 2	11.25" X 3.38" X 3.38"
PSDH-96W-24V	CLASS 2	11.25" X 3.38" X 3.37"

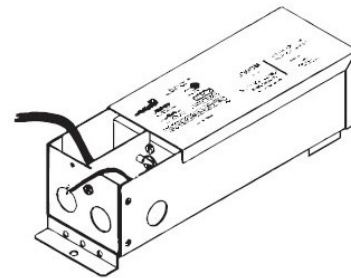

PSRX SERIES 4-IN-1 DIMMING DRIVER W/ JUNCTION BOX

PSRX-30W-24V-UNV	CLASS 2	6.5" X 3.7" X 1.57"
PSRX-60W-24V-UNV	CLASS 2	7.4" X 3.72" X 1.57"
PSRX-96W-24V-UNV	CLASS 2	8.66" X 3.72" X 1.57"
PSRX-150W-24V-UNV		10.24" X 4.13" X 1.77"
PSRX-200W-24V-UNV		10.24" X 4.13" X 1.77"
PSRX-300W-24V-UNV		10.94" X 4.33" X 1.77"

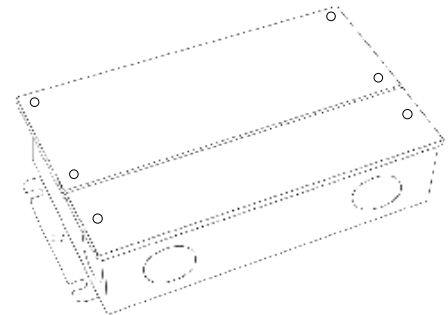

PSVT SERIES 0-10V DIMMING DRIVER

PSVT-60W-24V	CLASS 2	7.4" X 3.72" X 1.57"
PSVT-96W-24V	CLASS 2	8.66" X 3.72" X 1.57"
PSVT-200W-24V		10.24" X 4.13" X 1.77"
PSVT-288W-24V	CLASS 2	11.85" X 4.25" X 1.81"
PSVT-300W-24V		10.94" X 4.33" X 1.77"

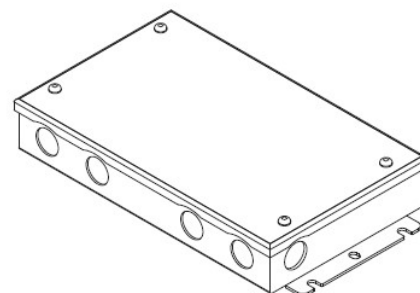

LSRN-20N

2.2W NAUTICAL OUTDOOR FLEXIBLE LED STRIP

COMPATIBLE TRANSFORMERS

PSDE SERIES 0-10V DIMMING W/ JUNCTION BOX

PSDE-60W-24V-010-JB	CLASS 2	12.1" X 2.36" X 1.4"
PSDE-96W-24V-010-JB	CLASS 2	12.1" X 2.36" X 1.4"

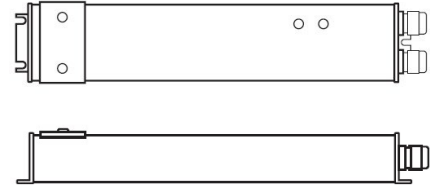

LUTRON 1% 3-WIRE DIMMING

L3DA4JTUKL-CV240	CLASS 2	4.89" X 4" X 2.62"
------------------	---------	--------------------

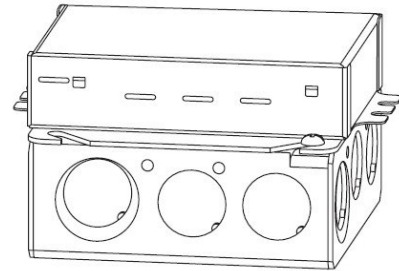

LUTRON 1% 3-WIRE DIMMING

PSDE-96W-24V-ECO	CLASS 2	10.5" X 3.0" X 2.0"
------------------	---------	---------------------

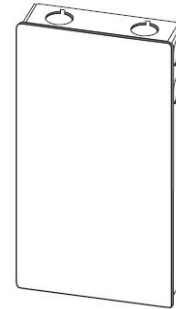

PSHK SERIES NON-DIMMING CONSTANT VOLTAGE WITH JUNCTION BOX

PSHK-30W-24V	CLASS 2	6.5" X 3.6" X 1.02"
PSHK-60W-24V	CLASS 2	7.4" X 3.62" X 1.02"
PSHK-96W-24V	CLASS 2	8.66" X 3.66" X 1.61"
PSHK-150W-24V		10.24" X 4.06" X 1.81"
PSHK-200W-24V		10.24" X 4.06" X 1.81"
PSHK-288W-24V	CLASS 2	11.85" X 4.25" X 1.82"
PSHK-300W-24V		10.24" X 4.25" X 1.81"

