

# LSMW-60

## 6.0W OUTDOOR FLEXIBLE LED STRIP

Project \_\_\_\_\_

Location \_\_\_\_\_

Quote/ Ref # \_\_\_\_\_

**LSMW-60** is an outdoor, wet-rated, dimmable LED strip capable of delivering 500 lumens of light output per Ft. Rated to last 50,000 hours making it an excellent replacement for halogen lighting. Its innovative low profile design makes it suitable for use in cove lighting, under cabinets, architectural and aesthetic enhancements.

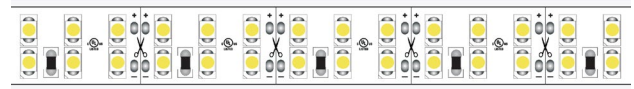

### SPECIFICATIONS

INPUT VOLTAGE	24V DC
POWER CONSUMPTION	6W/Ft.
NO. OF LEDS	72 LEDs per Ft.
LUMEN OUTPUT	473 Lm/Ft. (3000K)
CRI	95+
COLOR TEMPERATURE	22K / 24K / 27K / 30K / 35K 40K / 50K / 60K / BL
DIMMING	MLV, ELV, 0-10 and TRIAC
MAXIMUM RUN LENGTH	16 Ft.
CUTTABLE	Every 1 in (25.4mm)
BINNING	1.5 Step Macadam Elipse
OPERATING TEMPERATURE	-40°F (-40°C) ~ +140°F (+60°C)
BEAM ANGLE	120°
IP RATING	IP65 Wet Location
CERTIFICATIONS	UL Listed, TITLE 24 JA8
LUMEN MAINTENANCE	50,000 Hrs

### LUMENS

CCT	LM/ FT	CRI	R9	R13
2400K	431	94	78	97
2700K	463	89	57	93
3000K	473	89	71	93
3500K	486	88	69	92
4000K	507	88	69	92
5000K	522	88	66	92
6000K	525	87	67	92

\*Approved for closet / storage space installation per NEC 410.16(A)(3) and 410.16(C)(5)



MODEL	COLOR TEMP	LENGTH	VOLTAGE	PROFILE	
LSMW60	<b>22K</b> 2200K	<b>40K</b> 4000K	<b>16</b> 16 Ft.	<b>24</b> 24V DC	See Page 2 for compatible profiles.
	<b>24K</b> 2400K	<b>50K</b> 5000K			
	<b>27K</b> 2700K	<b>60K</b> 6000K			
	<b>30K</b> 3000K	<b>BL</b> Blue			
	<b>35K</b> 3500K				
		*1 = Custom length per FT. (Cuttable every 1")		* Custom color finishes require powder coating. Allow 7 days leads time.	

# LSMW-60

## 6.0W OUTDOOR FLEXIBLE LED STRIP

### DIMENSIONS

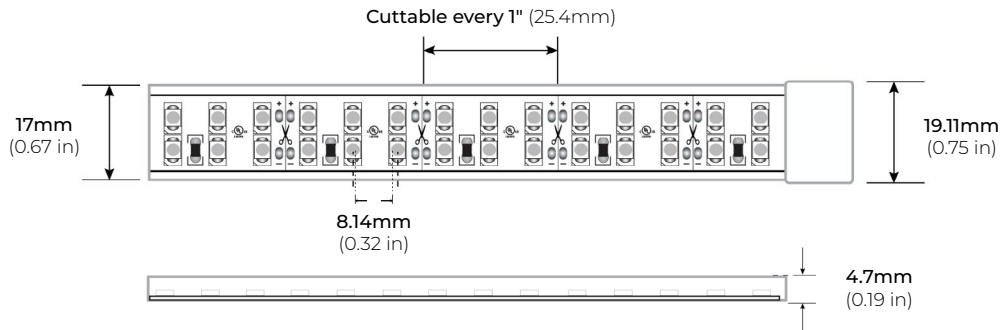

### COMPATIBLE ALUMINUM PROFILES

#### SURFACE PROFILES

##### ALU-DS100

LENGTHS 39" | 78" | 84"  
LENS Clear, Frosted  
FINISH Silver

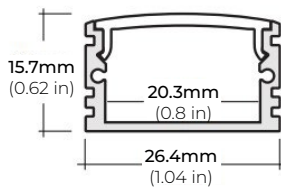

##### ALP-90

LENGTHS 48" | 96"  
LENS Frosted  
FINISH Silver

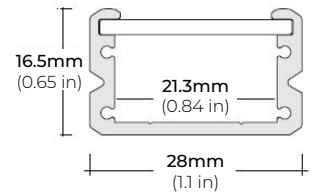

##### ALP-102

LENGTHS 49" | 98"  
LENS Frosted, Black, Asymmetric, Double Asymmetric  
FINISH Silver

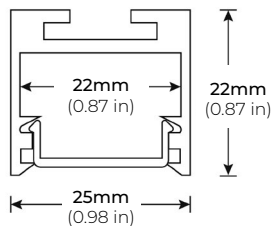

##### ALP-130

LENGTHS 49" | 84" | 98"  
LENS Frosted  
FINISH Silver | Black

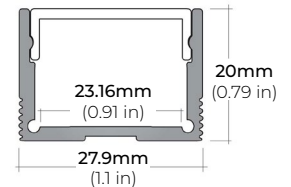

##### ALP-140

LENGTHS 48" | 98"  
LENS Frosted  
FINISH Silver

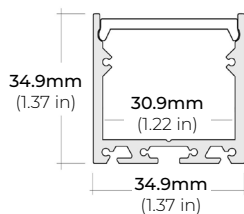

##### ALP-150LX

LENGTHS 49" | 98"  
LENS Frosted  
FINISH White | Black

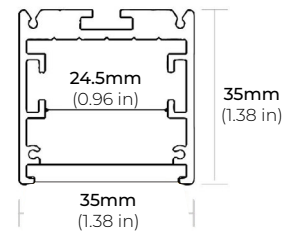

\* For more compatible profiles, visit [corelightingusa.com](http://corelightingusa.com)

#### RECESSED PROFILES

##### ALP-102R

LENGTHS 49" | 98"  
LENS Frosted, Black, Asymmetric, Double Asymmetric  
FINISH Silver

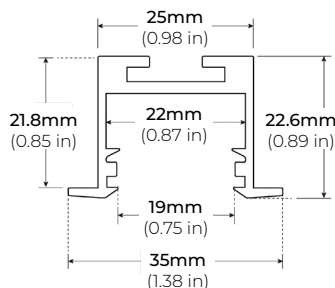

##### ALP-230RN

LENGTHS 49" | 98"  
LENS Frosted  
FINISH Silver

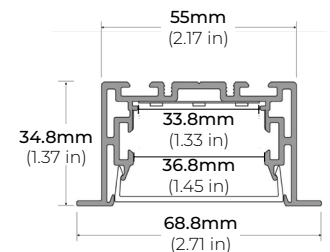

\* For more compatible profiles, visit [corelightingusa.com](http://corelightingusa.com)

# LSMW-60

## 6.0W OUTDOOR FLEXIBLE LED STRIP

### COMPATIBLE TRANSFORMERS

#### PSDL SERIES TRIAC DIMMABLE

PSDL-30W-24V	CLASS 2	6.5" X 3.63" X 1.03"
PSDL-60W-24V	CLASS 2	7.4" X 3.63" X 1.03"
PSDL-96W-24V	CLASS 2	8.67" X 3.67 X 1.62"
PSDL-150W-24V		8.67" X 3.67" X 1.62"
PSDL-192W-24V	CLASS 2	10.25" X 4.06" X 1.82"
PSDL-200W-24V		10.25" X 4.06" X 1.82"
PSDL-288W-24V	CLASS 2	10.25" X 4.06" X 1.82"
PSDL-300W-24V		10.25" X 4.06" X 1.82"

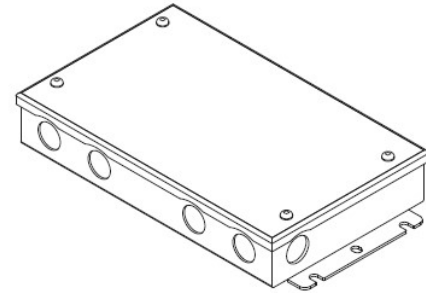

#### PSDH SERIES HIGH PERFORMANCE MAGNETIC LOW VOLTAGE (MLV)

PSDH-48W-24V	CLASS 2	11.25" X 3.37" X 3.25"
PSDH-96W-24V	CLASS 2	11.25" X 3.37" X 3.25"

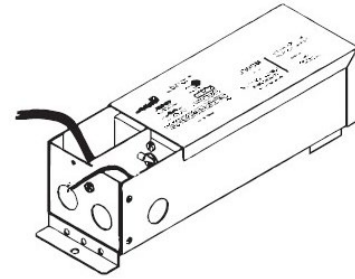

#### PSRX SERIES 4-IN-1 DIMMING DRIVER

PSRX-30W-24V	CLASS 2	6.5" X 3.72" X 1.57"
PSRX-60W-24V	CLASS 2	7.4" X 3.72" X 1.57"
PSRX-96W-24V	CLASS 2	8.66" X 3.72" X 1.57"
PSRX-150W-24V		10.24" X 4.13" X 1.77"
PSRX-192W-24V	CLASS 2	11" X 4" X 1.82"
PSRX-200W-24V		10.24" X 4.13" X 1.77"
PSRX-288W-24V	CLASS 2	11.85" X 4.25" X 1.82"
PSRX-300W-24V		10.94" X 4.33" X 1.77"

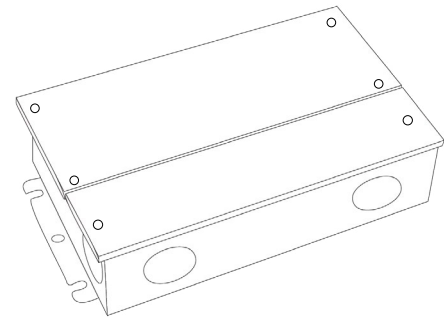

#### PSVT SERIES 0-10V DIMMING DRIVER

PSVT-60W-24V	CLASS 2	7.4" X 3.72" X 1.57"
PSVT-96W-24V	CLASS 2	8.66" X 3.72" X 1.57"
PSVT-200W-24V		10.24" X 4.13" X 1.77"
PSVT-288W-24V	CLASS 2	11.85" X 4.25" X 1.81"
PSVT-300W-24V		10.94" X 4.33" X 1.77"

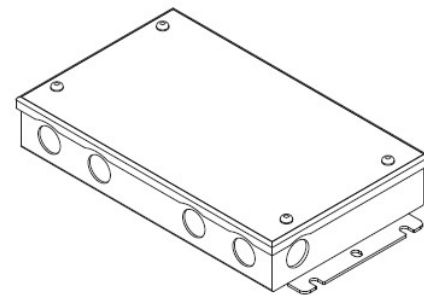

# LSMW-60

## 6.0W OUTDOOR FLEXIBLE LED STRIP

### COMPATIBLE TRANSFORMERS

#### PSDE SERIES

0-10V DIMMING W/ JUNCTION BOX

PSDE-60W-24V-010-JB	CLASS 2	12.1" X 2.36" X 1.4"
PSDE-96W-24V-010-JB	CLASS 2	12.1" X 2.36" X 1.4"

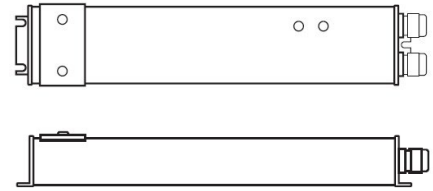

#### LUTRON 1%

3-WIRE DIMMING

L3DA4U1UKL-CV240	CLASS 2	4.89" X 4" X 2.62"
------------------	---------	--------------------

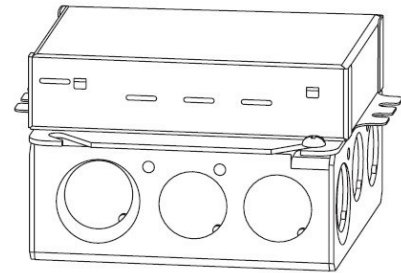

#### LUTRON 1%

PSDE-96W-24V-ECO	CLASS 2	10.5" X 3.0" X 2.0"
------------------	---------	---------------------

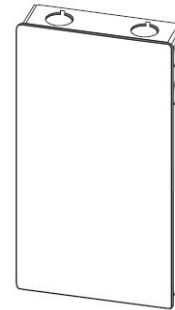

### COMPATIBLE NON-DIMMING DRIVERS

#### PSHK SERIES

NON-DIMMING CONSTANT VOLTAGE WITH JUNCTION BOX

PSHK-30W-24V	CLASS 2	6.5" X 3.6" X 1.02"
PSHK-60W-24V	CLASS 2	7.4" X 3.62" X 1.02"
PSHK-96W-24V	CLASS 2	8.66" X 3.66" X 1.61"
PSHK-150W-24V		10.24" X 4.06" X 1.81"
PSHK-200W-24V		10.24" X 4.06" X 1.81"
PSHK-288W-24V	CLASS 2	11.85" X 4.25" X 1.82"
PSHK-300W-24V		10.24" X 4.25" X 1.81"

