

# LSMW-32CB

## 3.2W OUTDOOR COB LINEAR LED STRIP

Project \_\_\_\_\_  
Location \_\_\_\_\_  
Quote/ Ref # \_\_\_\_\_

Delivering a solid stream of linear light, the **LSMW-32CB** features the latest in COB technology for total linear diffusion on a low profile package.



### SPECIFICATIONS

INPUT VOLTAGE	24V DC
POWER CONSUMPTION	3.2W/Ft.
LUMEN OUTPUT	292 Lm/Ft. (30K)
CRI	95+
DIMMING	MLV, ELV, 0-10 and TRIAC
MAXIMUM RUN LENGTH	16.4 Ft.
CUTTABLE	Every 2 in (50.8mm)
BINNING	2 Step Macadam Elipse
OPERATING TEMPERATURE	-40°F (-40°C) ~ +140°F (+60°C)
BEAM ANGLE	180°
IP RATING	IP65 wet location (outdoor)
CERTIFICATIONS	UL Listed, TITLE 24 JAB
LUMEN MAINTENANCE	50,000 Hrs.

### LUMENS

CCT	LM/ FT
2700K	272
3000K	292
4000K	297

\*Approved for closet / storage space installation per NEC 410.16(A)(3) and 410.16(C)(5)

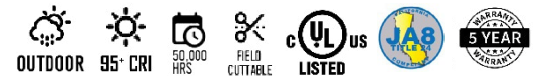

MODEL	COLOR TEMP	LENGTH	VOLTAGE	PROFILE
LSMW32CB	<b>27K</b> 2700K	<b>16</b> 16 Ft.	<b>24</b> 24V DC	See Page 3 for compatible profiles.
	<b>30K</b> 3000K	<b>32</b> 32 Ft.		
	<b>40K</b> 4000K	<b>1XX</b> per Ft.		
		*1 = Custom length per FT. (Cuttable every 2")		* Custom color finishes require powder coating. Allow 7 days leads time.

# LSMW-32CB

## 3.2W OUTDOOR COB LINEAR LED STRIP

### DIMENSIONS

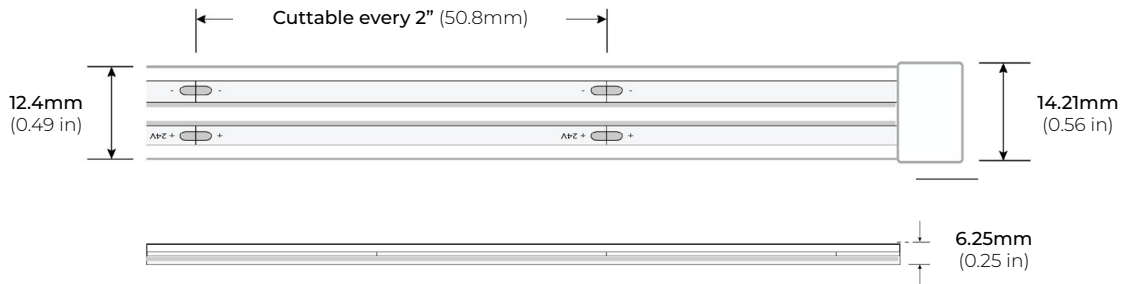

### COMPATIBLE ALUMINUM PROFILES

#### SURFACE PROFILES

##### ALU-DS100

LENGTHS 39" | 78" | 84"  
LENS Clear, Frosted  
FINISH Silver

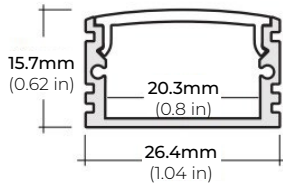

##### ALP-70

LENGTHS 49" | 84" | 98"  
LENS Frosted  
FINISH White | Black | Silver

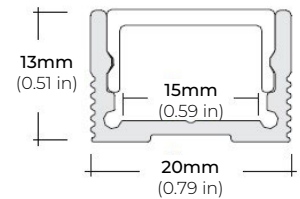

##### ALP-80

LENGTHS 49.25" | 98.5"  
LENS Frosted  
FINISH Silver

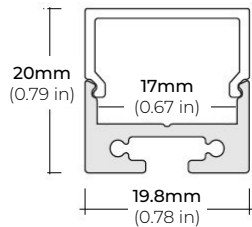

##### ALP-90

LENGTHS 48" | 96"  
LENS Frosted  
FINISH Silver

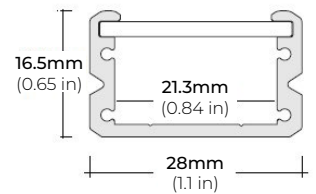

##### ALP-100C (CORNER)

LENGTHS 48" | 98"  
LENS Frosted  
FINISH Silver

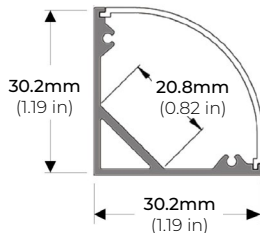

##### ALP-102

LENGTHS 49" | 98"  
LENS Frosted, Black, Asymmetric, Double Asymmetric  
FINISH Silver

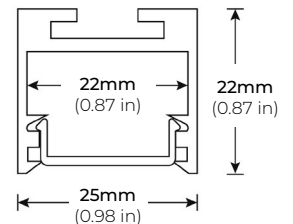

\* For more compatible profiles, visit [corelightingusa.com](http://corelightingusa.com)

#### RECESSED PROFILES

##### ALP-210RN

LENGTHS 49" | 98"  
LENS Frosted  
FINISH Silver

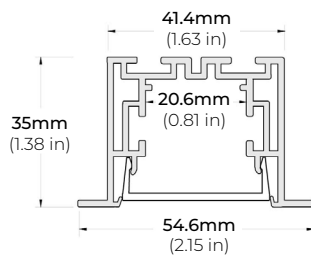

##### ALP-230RN

LENGTHS 49" | 98"  
LENS Frosted  
FINISH Silver

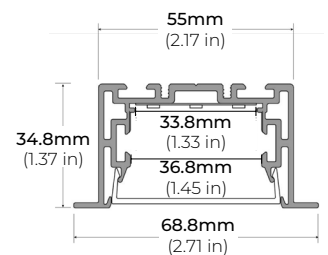

\* For more compatible profiles, visit [corelightingusa.com](http://corelightingusa.com)

# LSMW-32CB

## 3.2W OUTDOOR COB LINEAR LED STRIP

### COMPATIBLE TRANSFORMERS

#### PSDL SERIES TRIAC DIMMABLE

PSDL-30W-24V	CLASS 2	6.5" X 3.63" X 1.03"
PSDL-60W-24V	CLASS 2	7.4" X 3.63" X 1.03"
PSDL-96W-24V	CLASS 2	8.67" X 3.67 X 1.62"
PSDL-150W-24V		8.67" X 3.67" X 1.62"
PSDL-192W-24V	CLASS 2	10.25" X 4.06" X 1.82"
PSDL-200W-24V		10.25" X 4.06" X 1.82"
PSDL-288W-24V	CLASS 2	10.25" X 4.06" X 1.82"
PSDL-300W-24V		10.25" X 4.06" X 1.82"

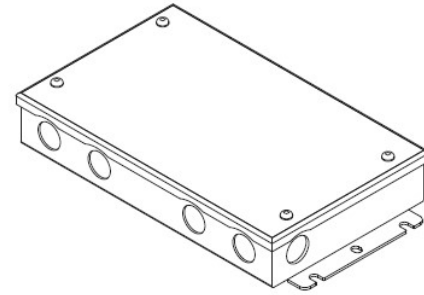

#### PSDH SERIES HIGH PERFORMANCE MAGNETIC LOW VOLTAGE (MLV)

PSDH-48W-24V	CLASS 2	11.25" X 3.37" X 3.25"
PSDH-96W-24V	CLASS 2	11.25" X 3.37" X 3.25"

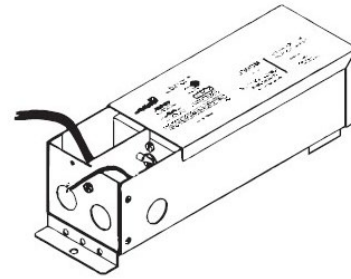

#### PSRX SERIES 4-IN-1 DIMMING DRIVER

PSRX-30W-24V	CLASS 2	6.5" X 3.72" X 1.57"
PSRX-60W-24V	CLASS 2	7.4" X 3.72" X 1.57"
PSRX-96W-24V	CLASS 2	8.66" X 3.72" X 1.57"
PSRX-150W-24V		10.24" X 4.13" X 1.77"
PSRX-192W-24V	CLASS 2	11" X 4" X 1.82"
PSRX-200W-24V		10.24" X 4.13" X 1.77"
PSRX-288W-24V	CLASS 2	11.85" X 4.25" X 1.82"
PSRX-300W-24V		10.94" X 4.33" X 1.77"

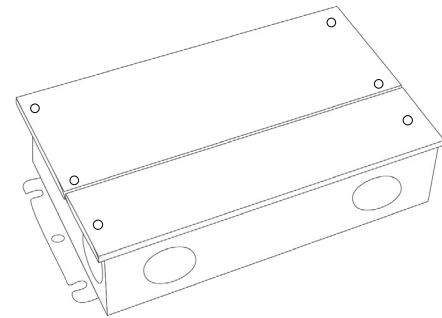

#### PSVT SERIES 0-10V DIMMING DRIVER

PSVT-60W-24V	CLASS 2	7.4" X 3.72" X 1.57"
PSVT-96W-24V	CLASS 2	8.66" X 3.72" X 1.57"
PSVT-200W-24V		10.24" X 4.13" X 1.77"
PSVT-288W-24V	CLASS 2	11.85" X 4.25" X 1.81"
PSVT-300W-24V		10.94" X 4.33" X 1.77"

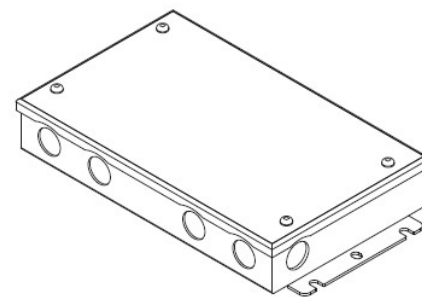

# LSMW-32CB

## 3.2W OUTDOOR COB LINEAR LED STRIP

### COMPATIBLE TRANSFORMERS

PSDE SERIES  
0-10V DIMMING W/ JUNCTION BOX

PSDE-60W-24V-010-JB	CLASS 2	12.1" X 2.36" X 1.4"
PSDE-96W-24V-010-JB	CLASS 2	12.1" X 2.36" X 1.4"

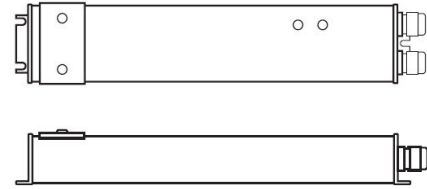

LUTRON 1%  
3-WIRE DIMMING

L3DA4U1UKL-CV240	CLASS 2	4.0" X 1.5" X 4.0"
------------------	---------	--------------------

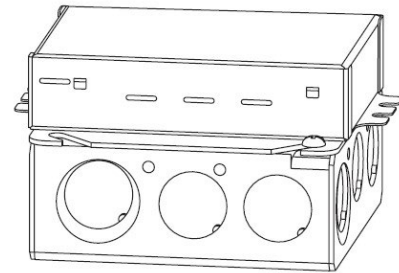

LUTRON 1%  
3-WIRE DIMMING

PSDE-96W-24V-ECO	CLASS 2	10.5" X 3.0" X 2.0"
------------------	---------	---------------------

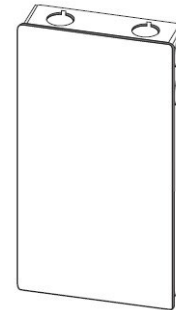

### COMPATIBLE NON-DIMMING DRIVERS

PSHK SERIES  
NON-DIMMING CONSTANT VOLTAGE WITH JUNCTION BOX

PSHK-30W-24V	CLASS 2	6.5" X 3.6" X 1.02"
PSHK-60W-24V	CLASS 2	7.4" X 3.62" X 1.02"
PSHK-96W-24V	CLASS 2	8.66" X 3.66" X 1.61"
PSHK-150W-24V		10.24" X 4.06" X 1.81"
PSHK-200W-24V		10.24" X 4.06" X 1.81"
PSHK-288W-24V	CLASS 2	11.85" X 4.25" X 1.82"
PSHK-300W-24V		10.24" X 4.25" X 1.81"

