

LSD-50

4.4W FLEXIBLE LED MINI MODULES

Project _____

Location _____

Quote/ Ref # _____

LSD-50 Mini Module incorporates the latest advancements in LED technology to deliver maximum lumen output. These low profile wet location modules are great for many common indoor/outdoor applications, and can be attached almost anywhere. These mini modules produce 90 lumens per watt, have virtually no heat and are great for tight spaces.

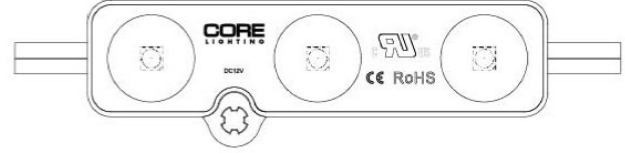

SPECIFICATIONS

INPUT VOLTAGE	12V 24V DC
POWER CONSUMPTION	4.4W/Ft.
LUMEN OUTPUT	360 Lm/Ft.
CRI	95+
COLOR TEMPERATURE	27K / 30K / 35K / 40K / 50K / 60K RD / GR / BL
DIMMING	MLV, ELV, 0-10 and TRIAC
MAXIMUM RUN LENGTH	25 Ft. (12V) 30 Ft. (24V)
CUTTABLE	Yes
BEAM ANGLE	160°
IP RATING	IP65 Wet Rated (Outdoor)
LUMEN MAINTENANCE	50,000 Hrs.

*Approved for closet / storage space installation per NEC 410.16(A)(3) and 410.16(C)(5)



MODEL	COLOR TEMP	LENGTH	VOLTAGE
LSD50	27K 2700K	1XX per Ft.	12 12V
	30K 3000K		
	35K 3500K		
	40K 4000K		
	50K 5000K		
	60K 6000K		
	RD Red		
	GR Green		*1 = Custom length per FT. Cutttable every 2.34"
BL Blue			

LSD-50

4.4W FLEXIBLE LED MINI MODULES

DIMENSIONS

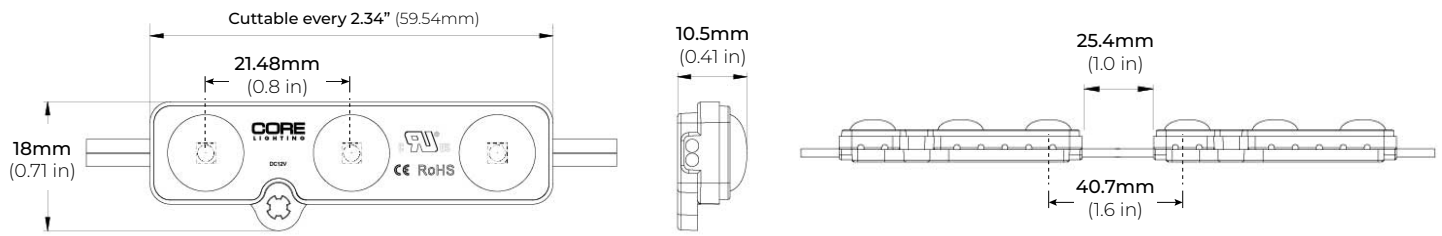

COMPATABLE ACCESSORIES

LSD50-MT
48" PVC MOUNTING TRACK

* Sold Separately

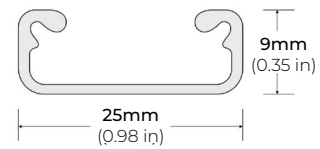

LSD-50

4.4W FLEXIBLE LED MINI MODULES

COMPATIBLE TRANSFORMERS

PSDL SERIES TRIAC DIMMABLE

PSDL-30W-12V	CLASS 2	6.5" X 3.63" X 1.58"
PSDL-60W-12V	CLASS 2	7.4" X 3.63" X 1.58"
PSDL-100W-12V	CLASS 2	8.67" X 3.67 X 1.62"
PSDL-150W-12V		10.25" X 4.06" X 1.82"
PSDL-200W-12V		10.25" X 4.06" X 1.82"
PSDL-300W-12V		10.25" X 4.06" X 1.82"

PSDL-30W-24V	CLASS 2	6.5" X 3.63" X 1.58"
PSDL-60W-24V	CLASS 2	7.4" X 3.63" X 1.58"
PSDL-96W-24V	CLASS 2	8.67" X 3.67 X 1.62"
PSDL-150W-24V		10.25" X 4.06" X 1.82"
PSDL-192W-24V	CLASS 2	11" X 4" X 1.82"
PSDL-200W-24V		10.25" X 4.06" X 1.82"
PSDL-288W-24V	CLASS 2	11.85" X 4.25" X 1.82"
PSDL-300W-24V		10.25" X 4.06" X 1.82"

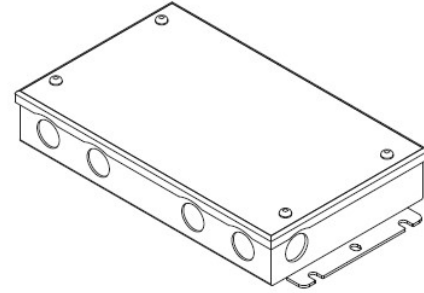

PSDH SERIES HIGH PERFORMANCE MAGNETIC LOW VOLTAGE (MLV)

PSDH-48W-24V	CLASS 2	11.25" X 3.38" X 3.38"
PSDH-96W-24V	CLASS 2	11.25" X 3.38" X 3.37"

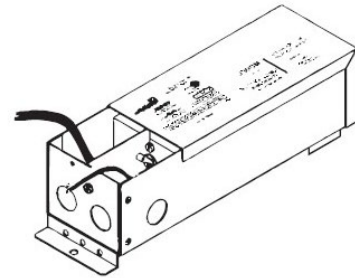

PSRX SERIES 4-IN-1 DIMMING DRIVER W/ JUNCTION BOX

PSRX-30W-12V-UNV	CLASS 2	6.5" X 3.72" X 1.57"
PSRX-60W-12V-UNV	CLASS 2	7.4" X 3.72" X 1.57"
PSRX-150W-12V-UNV		10.24" X 4.13" X 1.77"

PSRX-30W-24V-UNV	CLASS 2	6.5" X 3.7" X 1.57"
PSRX-60W-24V-UNV	CLASS 2	7.4" X 3.72" X 1.57"
PSRX-96W-24V-UNV	CLASS 2	8.66" X 3.72" X 1.57"
PSRX-150W-24V-UNV		10.24" X 4.13" X 1.77"
PSRX-200W-24V-UNV		10.24" X 4.13" X 1.77"
PSRX-300W-24V-UNV		10.94" X 4.33" X 1.77"

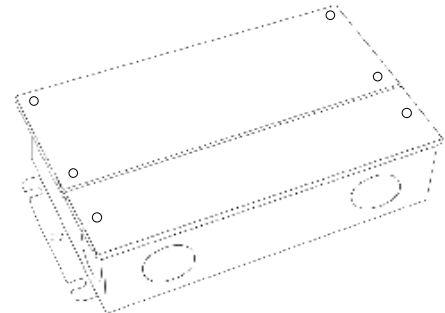

LSD-50

4.4W FLEXIBLE LED MINI MODULES

COMPATIBLE TRANSFORMERS

PSVT SERIES 0-10V DIMMING DRIVER

PSVT-60W-24V	CLASS 2	7.4" X 3.72" X 1.57"
PSVT-96W-24V	CLASS 2	8.66" X 3.72" X 1.57"
PSVT-200W-24V		10.24" X 4.13" X 1.77"
PSVT-288W-24V	CLASS 2	11.85" X 4.25" X 1.81"
PSVT-300W-24V		10.94" X 4.33" X 1.77"

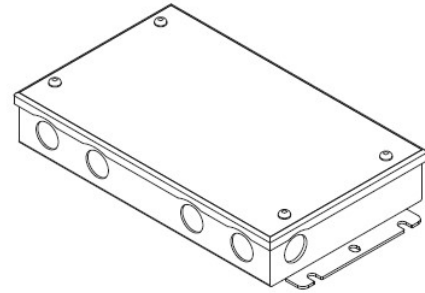

PSDE SERIES 0-10V DIMMING W/ JUNCTION BOX

PSDE-60W-24V-010-JB	CLASS 2	12.1" X 2.36" X 1.4"
PSDE-96W-24V-010-JB	CLASS 2	12.1" X 2.36" X 1.4"

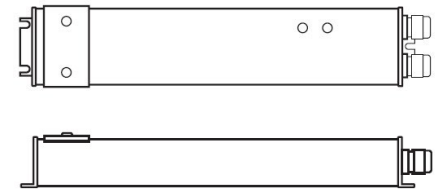

LUTRON 1% 3-WIRE DIMMING

L3DA4U1UKL-CV240	CLASS 2	4.0" X 1.5" X 4.0"
------------------	---------	--------------------

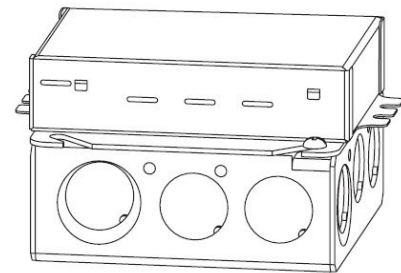

LUTRON 1% 3-WIRE DIMMING

PSDE-96W-24V-ECO	CLASS 2	10.5" X 3.0" X 2.0"
------------------	---------	---------------------

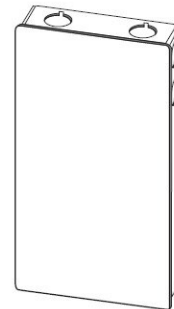

LSD-50

4.4W FLEXIBLE LED MINI MODULES

COMPATIBLE NON-DIMMING DRIVERS

PSHK SERIES

NON-DIMMING CONSTANT VOLTAGE WITH JUNCTION BOX

PSHK-30W-24V	CLASS 2	6.5" X 3.6" X 1.02"
PSHK-60W-24V	CLASS 2	7.4" X 3.62" X 1.02"
PSHK-96W-24V	CLASS 2	8.66" X 3.66" X 1.61"
PSHK-150W-24V		10.24" X 4.06" X 1.81"
PSHK-200W-24V		10.24" X 4.06" X 1.81"
PSHK-288W-24V	CLASS 2	11.85" X 4.25" X 1.82"
PSHK-300W-24V		10.24" X 4.25" X 1.81"

