

SLINQ RIGID

360° ROUND NEON SERIES

Project _____

Location _____

Quote/ Ref # _____

Slinq Rigid— IP65 rated, semi-rigid LED light is the perfect solution for those looking to create stunning 360° illuminating designs that stay in place. Whether you're looking to add some ambiance to your living space or create an eye-catching centerpiece, the Slinq Rigid is the perfect solution. Unleash your creativity to create any desired shape, freeform pattern, grid, icicle chandeliers, or simply drape it along walls and ceilings.

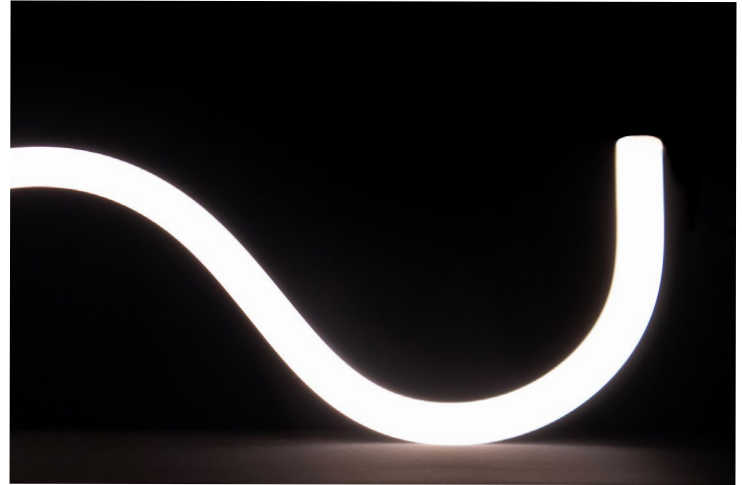

SPECIFICATIONS

POWER CONSUMPTION	6.08W per Ft.
LUMEN OUTPUT	359 Lumens per Ft. (30K)
CRI	90+
COLOR TEMPERATURE	24K/ 27K/ 30K/ 40K
MAXIMUM RUN LENGTH	98 in.
OPERATING VOLTAGE	24V
STORAGE TEMPERATURE	0°C (0°F) to 60°C (140°F)
OPERATING TEMPERATURE	-25°C (-13°F) to 55°C (131°F)
BEAM ANGLE	360°
IP RATING	IP65 Outdoor/ Wet Location
LUMEN MAINTENANCE	50,000 Hrs.

FEATURES

- 360° Light Source
- Universal Dimming
- 24V
- IP65 Outdoor Rated
- Factory-Installed Power Feed
- Injection Moulded End-Caps
- Ideal for Office, Decorative, Artistic Lighting

*This product is factory-cut only. Do not field modify.



MODEL	COLOR TEMP	LENGTH	VOLTAGE	POWER FEED	MOUNTING OPTIONS
SLQ25-RG	24K 2400K	XX* Per Inch *Increments of 1.16 in. Max run - 98 in. Lengths over 84 in. will incur additional handling fee	24V 24 Volts	EF72 72" End Feed	AR Arch
	27K 2700K			SF72 72" Side Feed	SF Surface Pendant
	30K 3000K				SUP Suspended Pendant
	40K 4000K				SCS Suspension Cable Support
					SJS Suspension Joiner Support
					TES Telescopic Extension Support
					TJS Telescopic Joiner Support

SLINQ RIGID

360° ROUND NEON SERIES

MOUNTING OPTIONS

ARCH (AR)

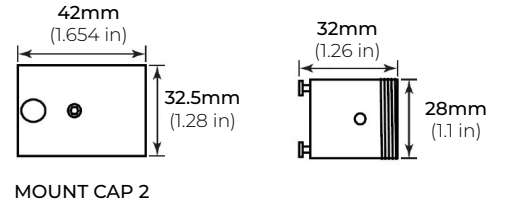
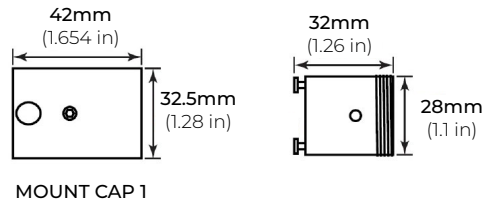
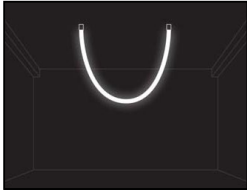

SURFACE PENDANT (SF)

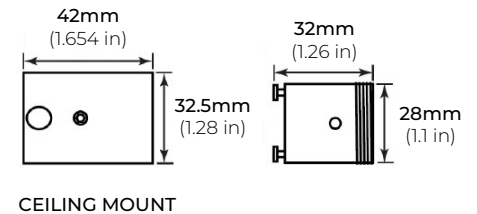
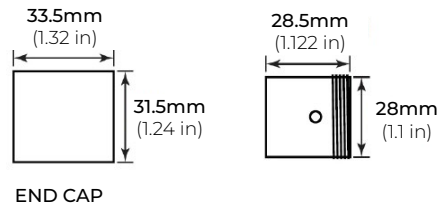
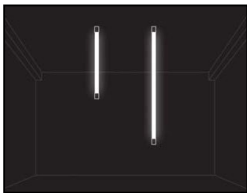

SUSPENDED PENDANT (SUP)

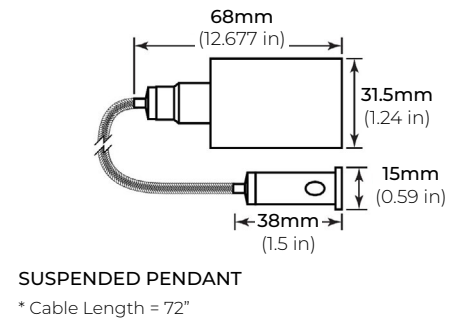
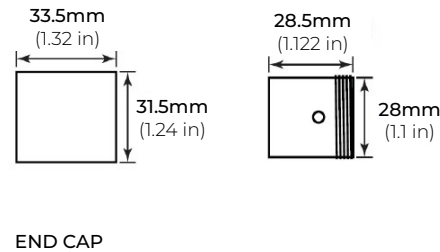
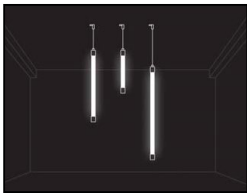

SUSPENSION CABLE SUPPORT (SCS)

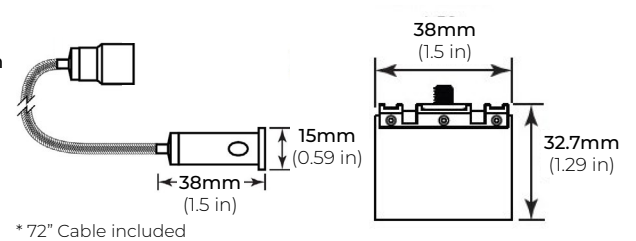
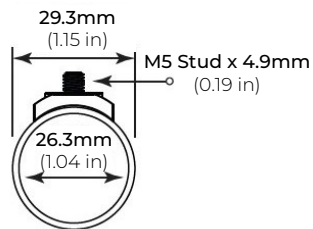
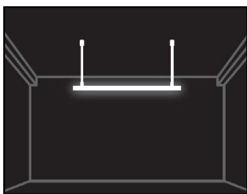

SLINQ RIGID

360° ROUND NEON SERIES

MOUNTING OPTIONS

SUSPENSION JOINER SUPPORT (SJS)

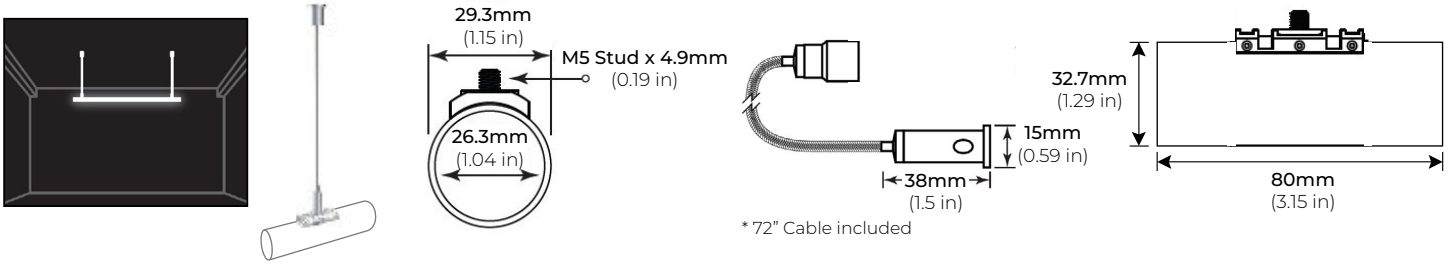

TELESCOPIC EXTENSION SUPPORT (TES)



TELESCOPIC JOINER SUPPORT (TJS)

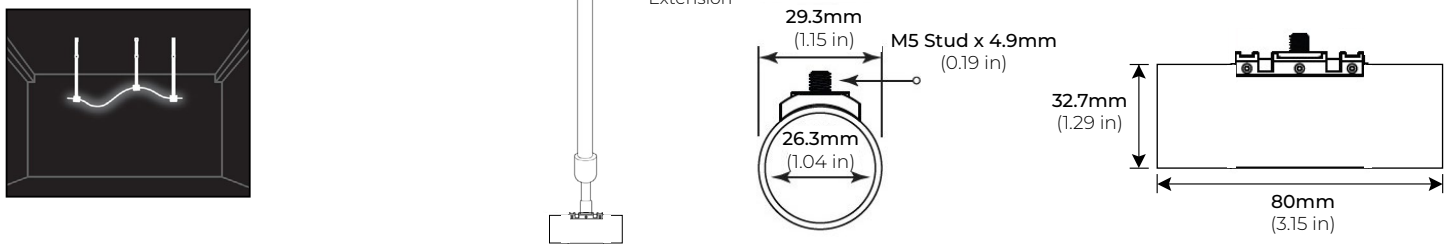

SLINQ RIGID

360° ROUND NEON SERIES

ACCESSORIES

SLQ25-RSM-WH
WHITE RECESSED MOUNT KIT
Ø64MM x 20mm (D x H)

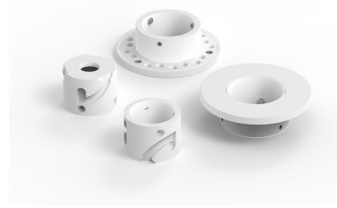

SLQ25-TSM-WH
WHITE TRIMLESS MOUNT KIT
Ø62MM x 20mm (D x H)

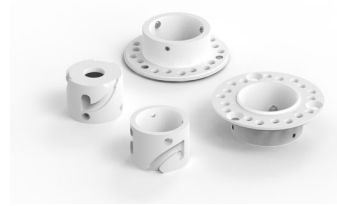

VISIBLE MOUNTING CLIP (VMC)

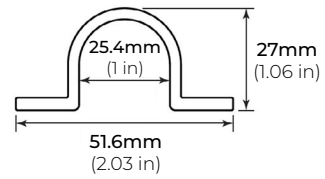

DISCREET MOUNTING BRACKET (DMB)

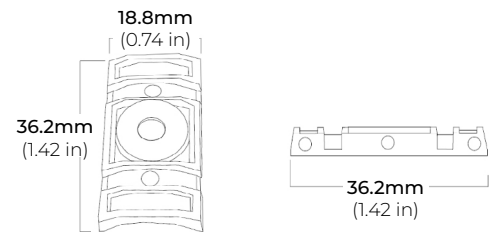

INFINITY JOINER (IJ)

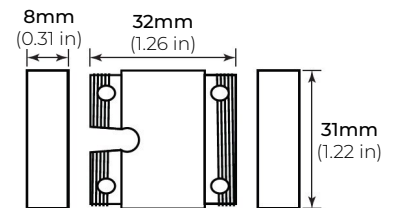
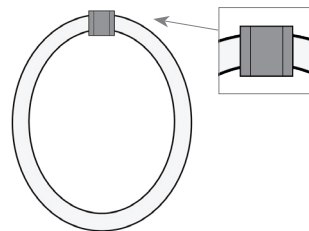

DIMENSIONS

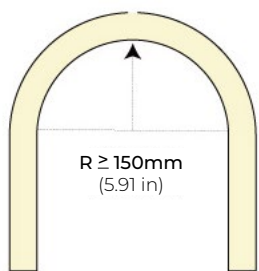

Minimum Bend Radius

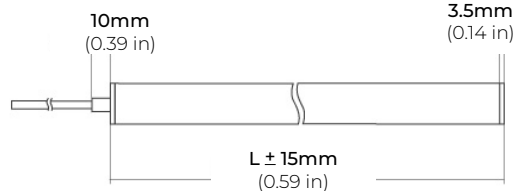

END FEED

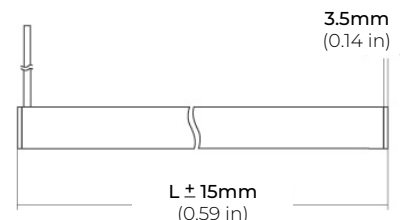

SIDE FEED

SLINQ RIGID

360° ROUND NEON SERIES

COMPATIBLE TRANSFORMERS

PSDL SERIES TRIAC DIMMABLE

PSDL-30W-24V	CLASS 2	6.5" X 3.63" X 1.03"
PSDL-60W-24V	CLASS 2	7.4" X 3.63" X 1.03"
PSDL-96W-24V	CLASS 2	8.67" X 3.67 X 1.62"
PSDL-150W-24V		8.67" X 3.67" X 1.62"
PSDL-192W-24V	CLASS 2	10.25" X 4.06" X 1.82"
PSDL-200W-24V		10.25" X 4.06" X 1.82"
PSDL-288W-24V	CLASS 2	10.25" X 4.06" X 1.82"
PSDL-300W-24V		10.25" X 4.06" X 1.82"

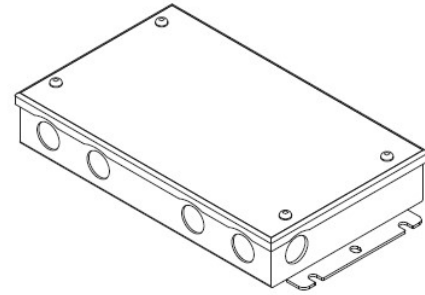

PSDH SERIES HIGH PERFORMANCE MAGNETIC LOW VOLTAGE (MLV)

PSDH-48W-24V	CLASS 2	11.25" X 3.37" X 3.25"
PSDH-96W-24V	CLASS 2	11.25" X 3.37" X 3.25"
PSDH-288W-24V	CLASS 2	14.25" X 8.43" X 4.43"

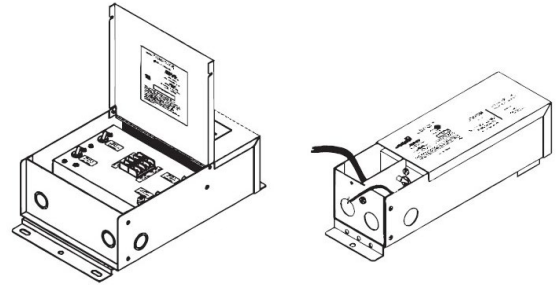

PSRX SERIES 4-IN-1 DIMMING DRIVER

PSRX-30W-24V	CLASS 2	6.5" X 3.72" X 1.57"
PSRX-60W-24V	CLASS 2	7.4" X 3.72" X 1.57"
PSRX-96W-24V	CLASS 2	8.66" X 3.72" X 1.57"
PSRX-150W-24V		10.24" X 4.13" X 1.77"
PSRX-192W-24V	CLASS 2	11" X 4" X 1.82"
PSRX-200W-24V		10.24" X 4.13" X 1.77"
PSRX-288W-24V	CLASS 2	11.85" X 4.25" X 1.82"
PSRX-300W-24V		10.94" X 4.33" X 1.77"

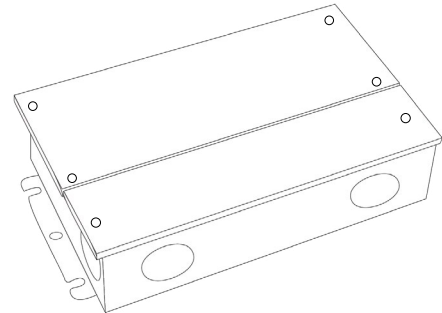

PSVT SERIES 4-IN-1 DIMMING DRIVER

PSVT-60W-24V	CLASS 2	7.4" X 3.72" X 1.57"
PSVT-96W-24V	CLASS 2	8.66" X 3.72" X 1.57"
PSVT-200W-24V		10.24" X 4.13" X 1.77"
PSVT-288W-24V	CLASS 2	11.85" X 4.25" X 1.81"
PSVT-300W-24V		10.94" X 4.33" X 1.77"

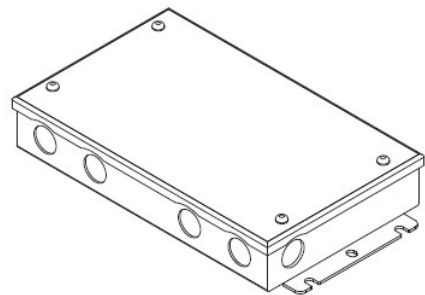

SLINQ RIGID

360° ROUND NEON SERIES

COMPATIBLE TRANSFORMERS

PSDE SERIES

0-10V DIMMING W/ JUNCTION BOX

PSDE-60W-24V-010-JB	CLASS 2	12.1" X 2.36" X 1.4"
PSDE-96W-24-010-JB	CLASS 2	12.1" X 2.36" X 1.4"

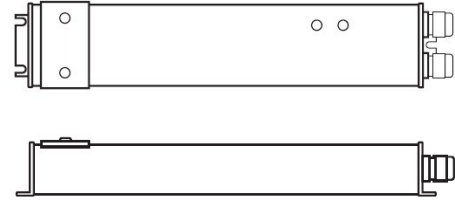

LUTRON 1%

3-WIRE DIMMING

L3DA4U1UKL-CV240	CLASS 2	4.89" X 4" X 2.62"
------------------	---------	--------------------

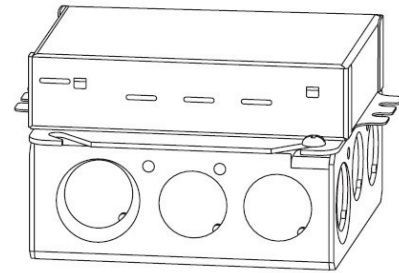

PSDE-96W-24V-ECO	CLASS 2	10.5" X 3.0" X 2.0"
------------------	---------	---------------------

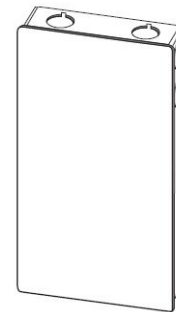

COMPATIBLE NON-DIMMING DRIVERS

PSHK SERIES

NON-DIMMING CONSTANT VOLTAGE WITH JUNCTION BOX

PSHK-30W-24V	CLASS 2	6.5" X 3.6" X 1.02"
PSHK-60W-24V	CLASS 2	7.4" X 3.62" X 1.02"
PSHK-96W-24V	CLASS 2	8.66" X 3.66" X 1.61"
PSHK-150W-24V		10.24" X 4.06" X 1.81"
PSHK-200W-24V		10.24" X 4.06" X 1.81"
PSHK-288W-24V	CLASS 2	11.85" X 4.25" X 1.82"
PSHK-300W-24V		10.24" X 4.25" X 1.81"

