

SLINQ RGBW

RGBW FLEXIBLE 360° ROUND NEON SERIES

Project _____

Location _____

Quote/ Ref # _____

Unleash your creativity with the **SLINQ RGBW**. Designed for ultimate flexibility, it supports a range of mounting options—including pendant, suspended, flush, arch, and freeform installations. Its 360° light output ensures seamless illumination from any angle or orientation. Explore the limitless design potential of the SLINQ Neon Series.

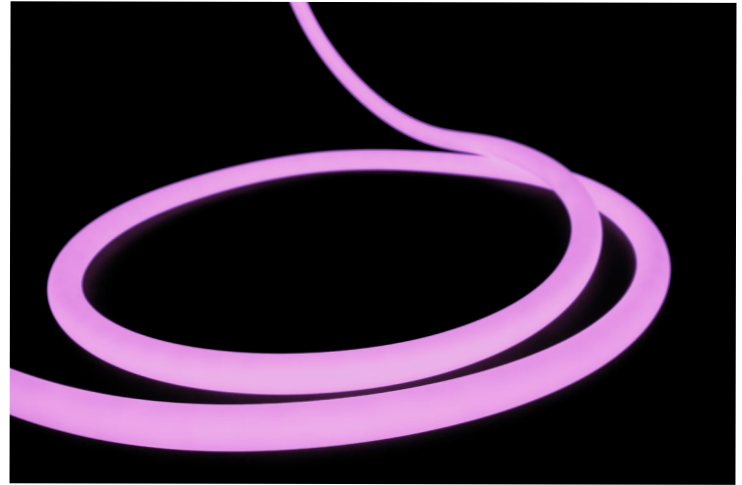

SPECIFICATIONS

POWER CONSUMPTION	6W per Ft.
LUMEN OUTPUT	174 Lm/ Ft. (24V) 165 Lm/ Ft. (48V)
CRI	90+
COLOR TEMPERATURE	RGB+23K/ RGB+27K/ RGB+32K/ RGB+45K
MAXIMUM RUN LENGTH	16 Ft. (24V)/ 32 Ft. (48V)
OPERATING VOLTAGE	24V/ 48V
STORAGE TEMPERATURE	0°F (0°C) ~ 140°F (60°C)
OPERATING TEMPERATURE	-13°F (-25°C) ~ 131°F (55°C)
BEAM ANGLE	360°
IP RATING	IP65 Outdoor/ Wet Location
LUMEN MAINTENANCE	50,000 Hrs.

FEATURES

- 360° Light Source
- Multiple Mounting Options
- Universal Dimming
- Available in 24V and 48V DC
- IP65 Outdoor Rated
- Factory-Installed Power Feed
- Injection Moulded End-Caps
- Ideal for Decorative, Retail, Artistic Lighting

*This product is factory-cut only. Do not field modify.



MODEL	COLOR TEMP	LENGTH	VOLTAGE	POWER FEED	MOUNTING OPTIONS
SLQ25-FX	RGBW23K RGB+2300K	PF Per Foot	24V 24 Volts	EF72 72" End Feed	AR Arch
	RGBW27K RGB+2700K		48V 48 Volts	SF72 72" Side Feed	SF Surface Pendant
	RGBW32K RGB+3200K				SUP Suspended Pendant
	RGBW45K RGB+4500K				SCS Suspension Cable Support
					SJS Suspension Joiner Support
					TES Telescopic Extension Support
					TJS Telescopic Joiner Support
		*1 = Custom length per FT. (24V - Every 2.46") (48V - Every 4.92")		*MAX RUN: 24V - 16 Ft. 48V - 32 Ft.	

SLINQ RGBW

RGBW FLEXIBLE 360° ROUND NEON SERIES

MOUNTING OPTIONS

ARCH (AR)

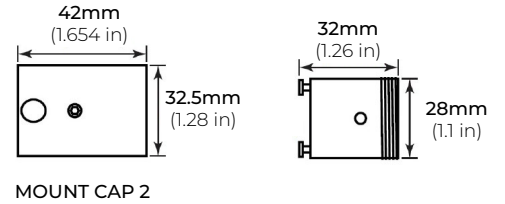
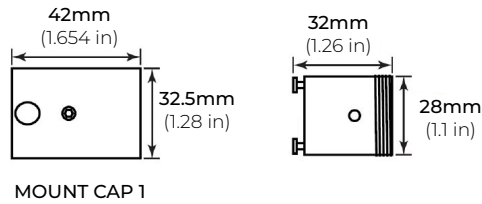
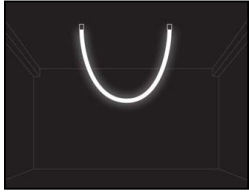

SURFACE PENDANT (SF)

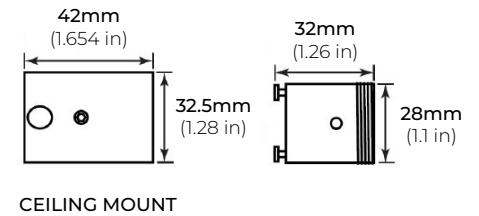
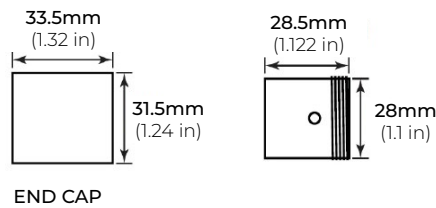
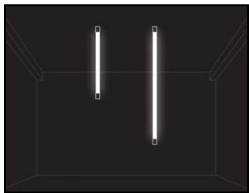

SUSPENDED PENDANT (SUP)

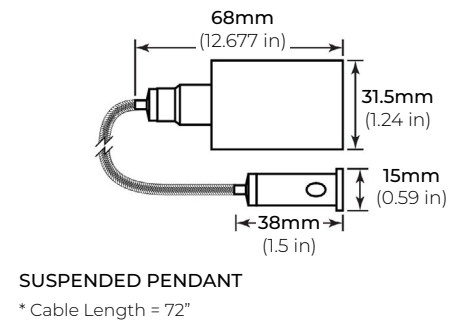
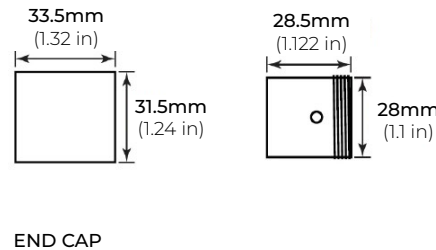
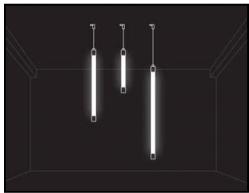

SUSPENSION CABLE SUPPORT (SCS)

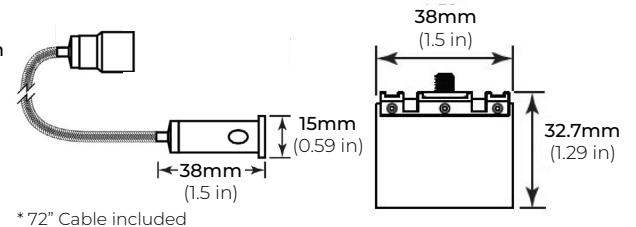
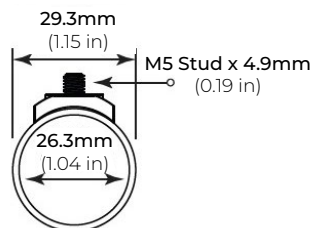
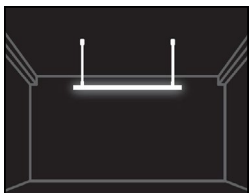

SLINQ RGBW

RGBW FLEXIBLE 360° ROUND NEON SERIES

MOUNTING OPTIONS

SUSPENSION JOINER SUPPORT (SJS)

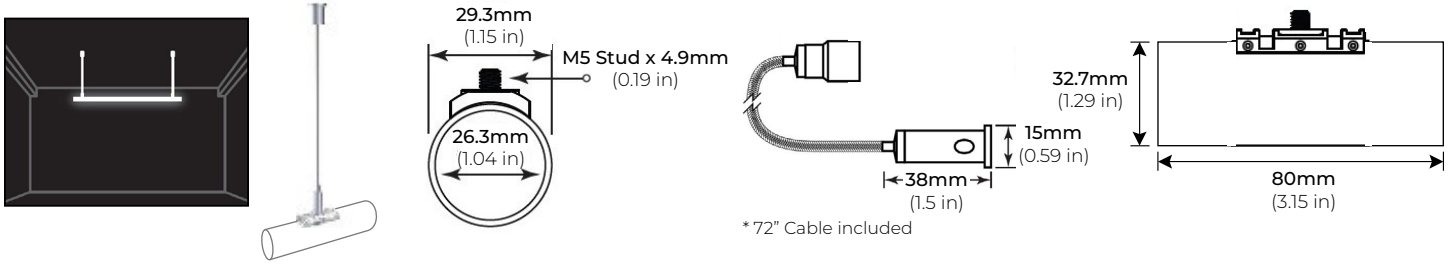

TELESCOPIC EXTENSION SUPPORT (TES)

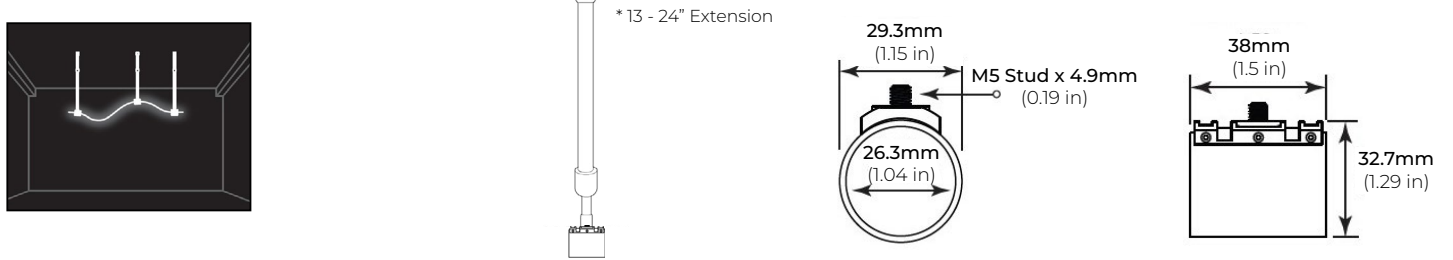

TELESCOPIC JOINER SUPPORT (TJS)

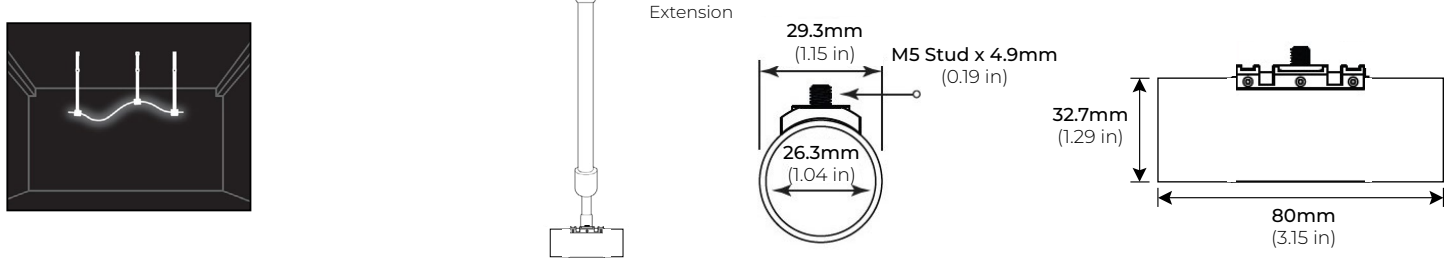

SLINQ RGBW

RECESSED TRIMLESS 360° ROUND NEON SERIES

ACCESSORIES

SLQ25-RSM-WH
WHITE RECESSED MOUNT KIT
Ø64MM x 20mm (D x H)

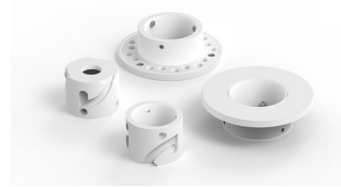

SLQ25-TSM-WH
WHITE TRIMLESS MOUNT KIT
Ø62MM x 20mm (D x H)

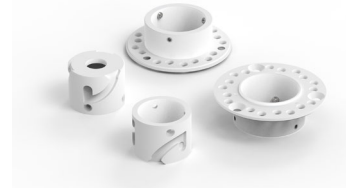

SLQ25-VMC
VISIBLE MOUNTING CLIP

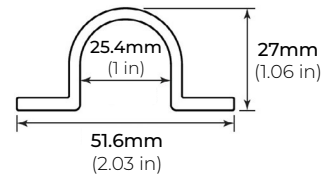

SLQ25-DMB
DISCREET MOUNTING BRACKET

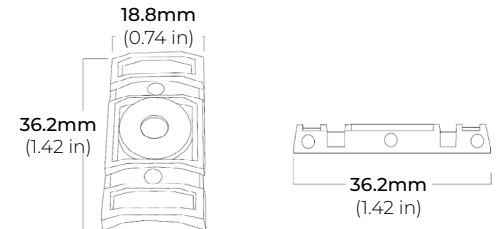

SLQ25-IJ
INFINITY JOINER

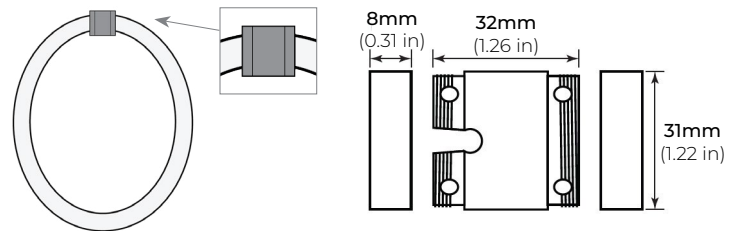

SLQ25-RTS-39-S
39" RIGID TUBE

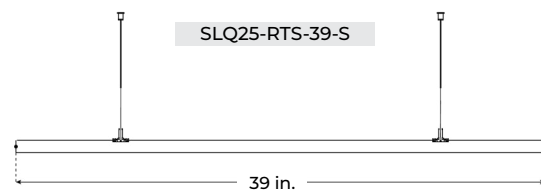

SLQ25-RTS-78-S
78" RIGID TUBE

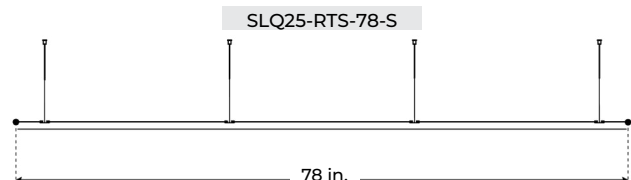

SLINQ RGBW

RGBW FLEXIBLE 360° ROUND NEON SERIES

ACCESSORIES

ROUND PLATE SUSPENSION KIT

SLQ25-RPS-BK SMALL ROUND PLATE (BLACK)
SLQ25-RPM-BK MEDIUM ROUND PLATE (BLACK)
SLQ25-RPL-BK LARGE ROUND PLATE (BLACK)

SLQ25-RPS-WH SMALL ROUND PLATE (WHITE)
SLQ25-RPM-WH MEDIUM ROUND PLATE (WHITE)
SLQ25-RPL-WH LARGE ROUND PLATE (WHITE)

*SCREWS INCLUDED

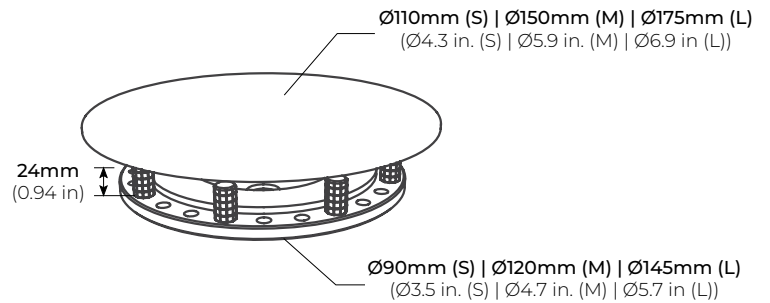

DIMENSIONS

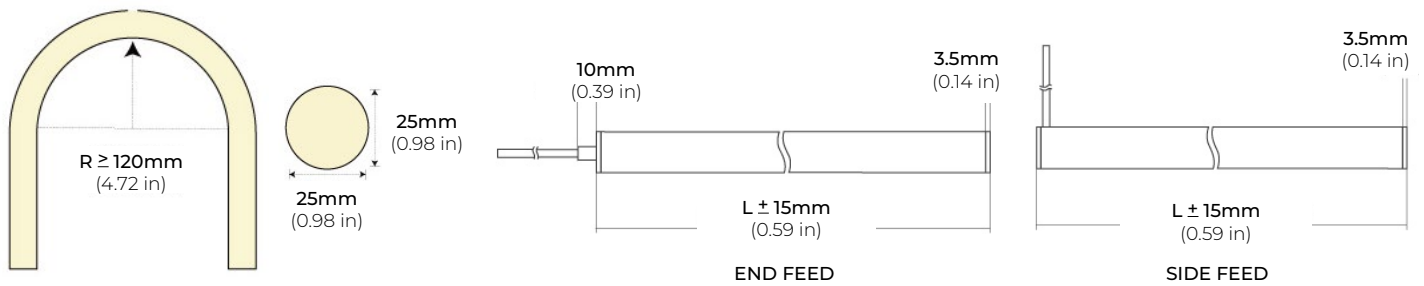

LIGHT DISTRIBUTION

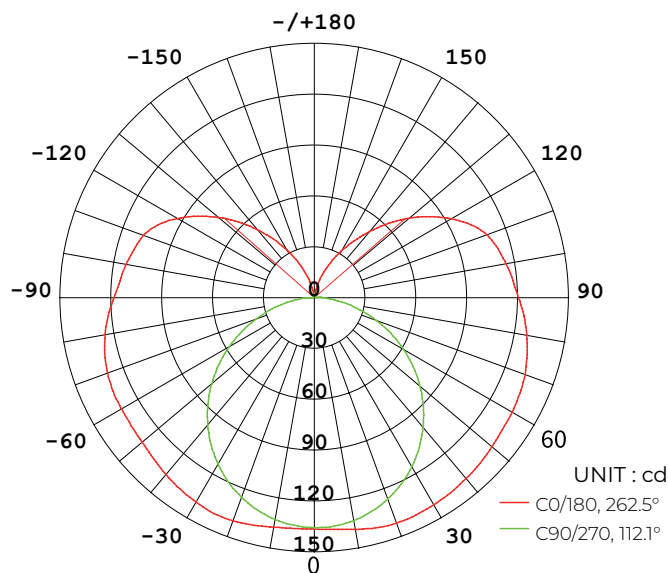

AVERAGE BEAM ANGLE (50%): 187.3°

FLUX OUT: 630.0 LM

1m	0.0000, 136.6 lx	22917.70cm
2m	0.0000, 34.15 lx	45835.40cm
3m	0.0000, 15.18 lx	68753.09cm
4m	0.0000, 8.537 lx	91670.79cm
5m	0.0000, 5.464 lx	114588.49cm
6m	0.0000, 3.794 lx	137506.19cm
7m	0.0000, 2.788 lx	160423.89cm
8m	0.0000, 2.134 lx	183341.59cm
9m	0.0000, 1.686 lx	206259.28cm
10m	0.0000, 1.366 lx	229176.98cm

HEIGHT EAVG, EMA X ANGLE: 179° DIAMETER

SLINQ RGBW

RGBW FLEXIBLE 360° ROUND NEON SERIES

DMX CONTROLLERS

All DMX Controllers require a DMX Decoder and Non-Dimming Driver.
Please refer for page 7 and 9 for compatible options.

RGB CT600 MULTI-FUNCTION RGBW WALL CONTROLLER

INPUT VOLTAGE	5V DC, 1A
OUTPUT SIGNAL	RF 2.4GHZ + DMX512
CONTROL	4 ZONES
COLOR OPTIONS	Black/ White
WORKING TEMP	-20°C ~ 40°C
DIMENSIONS	LxWxH (5.19"x7.08"x1.38")

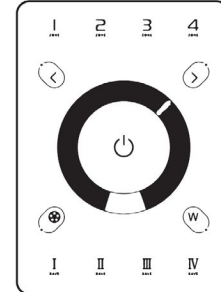

RGB-SCW4 WiFi DMX WALL CONTROLLER

INPUT VOLTAGE	5 - 10V DC, 06A
OUTPUT SIGNAL	DMX512 (x2)
PROGRAMMABILITY	PC/ MAC
COLOR OPTIONS	Black/ White
CONNECTIONS	USB/ 8dry contact ports/ Open drain output (for relay)
MEMORY	Built-In Flash
WORKING TEMP	-10°C ~ 45°C
DIMENSIONS	LxWxH (5.75"x4.17"x0.43")

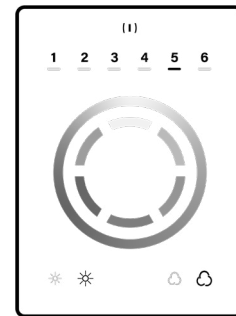

RGB-SDE3 WiFi DMX WALL CONTROLLER

INPUT VOLTAGE	6V DC, 0.6A
OUTPUT SIGNAL	DMX512 (x2)
PROGRAMMABILITY	PC/ MAC/ Tablet/ Smartphone
COLOR OPTIONS	Black/ White
CONNECTIONS	USB/ Ethernet/ RS232/ CLock/ 8dry contact ports/ 5V output relay
MEMORY	MicroSD Card
WORKING TEMP	-20°C ~ 40°C
DIMENSIONS	LxWxH (5.75"x4.17"x0.43")

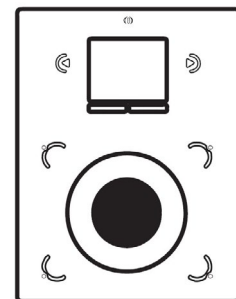

SLINQ RGBW

RGBW FLEXIBLE 360° ROUND NEON SERIES

DMX DECODERS

All DMX Decoders require a DMX Controller and Non-Dimming Driver.
Please refer for page 6 and 9 for compatible options.

RGB-DMX-4C-RJ45 4-CHANNEL DMX DECODER

INPUT VOLTAGE 12V-24V DC
OUTPUT CURRENT 8A X 4CH
OUTPUT WATTAGE 4 x (96W ~ 288W)
OUTPUT CHANNELS 4
DIMENSIONS LxWxH (6.5"x2.38"x1.27")

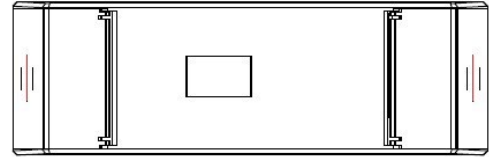

RGB-DMX-5C-XLR 5-CHANNEL DMX DECODER

INPUT VOLTAGE 12V-24V DC
OUTPUT CURRENT 8A X 5CH
OUTPUT WATTAGE 5 x (96W ~ 192W)
OUTPUT CHANNELS 5
DIMENSIONS LxWxH (6.45"x2.87"x1.5")

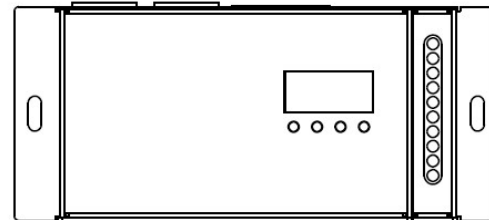

SLINQ RGBW

RGBW FLEXIBLE 360° ROUND NEON SERIES

NON-DMX CONTROLLERS

RGB-CT550

RGBW WIRELESS RECEIVER / CONTROLLER SYSTEM

REMOTE DISTANCE	100 Ft. (Line of Sight)
FREQUENCY	2.4 GHz
DIMENSIONS	LxWxH (6.38"x1.65"x0.59")
WEIGHT	0.44lbs.

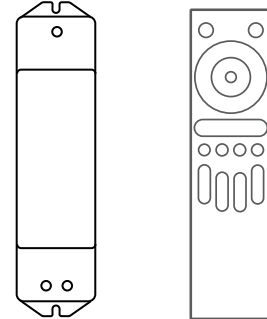

* RGB-CT500-RX
(Sold Separately)

RGB-CT550-RX

RGBW WIRELESS RECEIVER / CONTROLLER SYSTEM

INPUT VOLTAGE	DC5V ~ DC24V
POWER CAPACITY	100W (5V) 240W (12V) 480W (24V)
OUTPUT CURRENT	5A per Channel (20A Total)
WORKING TEMP	-30°C~55°C (-22°F~131°F)
DIMENSIONS	LxWxH (6.89"x1.73"x1.18")

* RGB-CT500-RX (Sold Separately)

RGB-CT700

MASTER RGBW WIFI CONTROLLER

INPUT VOLTAGE	12-24V DC
OUTPUT TYPE	Constant Voltage
POWER CAPACITY	288W (12V) 384W (24V)
OUTPUT CURRENT	5A per Channel (20A Total)
WORKING TEMP	-4°F (-20°C) ~ 122°F (50°C)
DIMENSIONS	LxWxH (7 x1.8 x 0.8")

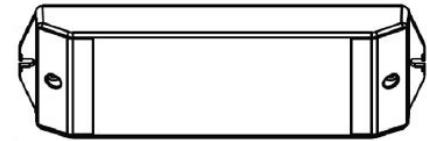

* Paired with RGB-CT705ZR (Sold Separately)

RGB-CT705ZR

SLAVE RGBW WIFI CONTROLLER

INPUT VOLTAGE	12-24V DC
OUTPUT TYPE	Constant Voltage
POWER CAPACITY	288W (12V) 384W (24V)
OUTPUT CURRENT	5A per Channel (20A Total)
WORKING TEMP	-4°F (-20°C) ~ 122°F (50°C)
DIMENSIONS	LxWxH (7 x0,63 x 0.71")

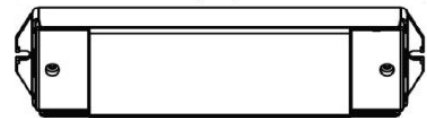

* Paired with RGB-CT700 (Sold Separately)

SLINQ RGBW

RGBW FLEXIBLE 360° ROUND NEON SERIES

NON-DMX CONTROLLERS (CONTINUED)

RGB-CT840 BLUETOOTH TOUCH PANEL WALL CONTROLLER

INPUT VOLTAGE	12-24V DC
ZONES	4
CONTROL MODE	RGB RGBW
WIRELESS PROTOCOL	Bluetooth 5.0 SIG Mesh
WORKING TEMP	-20°C ~ 55°C
DIMENSIONS	LxWxH (4.7"x3"x1.2")

* Paired with RGB-CT800-RC (Sold Separately)



RGB-CT800-RC BLUETOOTH CONSTANT VOLTAGE LED RECEIVER

INPUT VOLTAGE	12V 24V
OUTPUT CURRENT	4Ax5CH / 5Ax4CH (20A Max)
POWER CAPACITY	240W (12V) 480W (24V)
PROGRAMMABILITY	iOS and Android
WORKING TEMP	-20°C ~ 55°C
DIMENSIONS	LxWxH (6.9 x1.7 x 1.2")

* Paired with RGB-CT840 (Sold Separately)



COMPATIBLE 24V NON-DIMMING DRIVERS

PSHK SERIES NON-DIMMING CONSTANT VOLTAGE WITH JUNCTION BOX

PSHK-30W-24V	CLASS 2	6.5" X 3.6" X 1.02"
PSHK-60W-24V	CLASS 2	7.4" X 3.62" X 1.02"
PSHK-96W-24V	CLASS 2	8.66" X 3.66" X 1.61"
PSHK-150W-24V		10.24" X 4.06" X 1.81"
PSHK-200W-24V		10.24" X 4.06" X 1.81"
PSHK-288W-24V	CLASS 2	11.85" X 4.25" X 1.82"
PSHK-300W-24V		10.24" X 4.25" X 1.81"

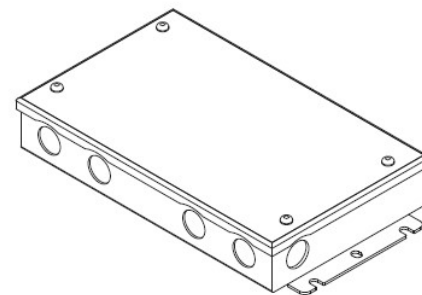

COMPATIBLE 48V TRANSFORMERS

PSRX SERIES 4-IN-1 DIMMING DRIVER W/ JUNCTION BOX

PSRX-200W-48V-UNV	10.24" X 4.13" X 1.77"
PSRX-300W-48V-UNV	10.24" X 4.13" X 1.77"

