

LSM-35TN

3.0W INDOOR 5MM WIDE FLEXIBLE LED STRIP

Project _____

Location _____

Quote/ Ref # _____

LSM35TN is a **5MM wide**, dimmable flexible LED strip capable of delivering up to 285 lumens of light output per Ft. Ideal for low profile and narrow installations, this LED strip light was designed for easy installation. 3M adhesive backing to stick to most surfaces and is field cuttable.



SPECIFICATIONS

INPUT VOLTAGE	24V DC
POWER CONSUMPTION	3W per Ft.
NO. OF LEDS	60 LEDs per Ft.
LUMEN OUTPUT	up to 285 Lm/Ft.
CRI	95+
COLOR TEMPERATURE	27K / 30K / 35K / 40K
DIMMING	MLV, ELV, 0-10 and TRIAC
MAXIMUM RUN LENGTH	12 Ft.
CUTTABLE	Every 1.5 in (38.3mm)
BINNING	1.5 Step Macadam Elipse
OPERATING TEMPERATURE	-40°F (-40°C) ~ +140°F (+60°C)
BEAM ANGLE	120°
IP RATING	IP45 dry location (Indoor)
CERTIFICATIONS	UL Listed, TITLE 24 JA8
LUMEN MAINTENANCE	50,000 Hrs.

LUMENS

CCT	LM/ FT	CRI	R9	R13
2700K	274	97	90	100
3000K	262	96	96	96
3500K	282	94	87	95
4000K	285	95	94	96

*Approved for closet / storage space installation per NEC 410.16(A)(3) and 410.16(C)(5)

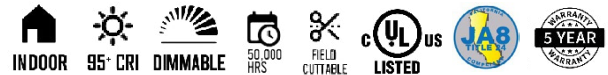

MODEL	COLOR TEMP	LENGTH	VOLTAGE	PROFILE
LSM35TN	27K 2700K	16 16 Ft.	24V 24V DC	<i>See Page 2 for compatible profiles.</i>
	30K 3000K	100 100 Ft.		
	35K 3500K	1XX per Ft.		
	40K 4000K			
		*1 = Custom length per FT. (Cuttable every 1.5")		* Custom color finishes require powder coating. Allow 7 days leads time.

LSM-35TN

3.0W INDOOR 5MM WIDE FLEXIBLE LED STRIP

DIMENSIONS

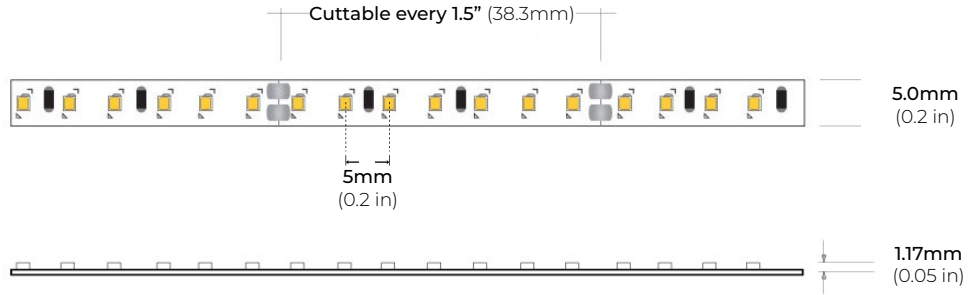

COMPATIBLE ALUMINUM PROFILES

SURFACE PROFILES

ALP-30C

LENGTHS 49" | 98"
LENS Frosted
FINISH Silver

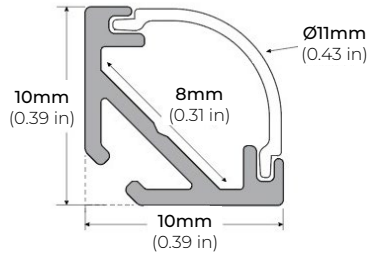

ALP-40

LENGTHS 49.25" | 98.5"
LENS Frosted
FINISH Silver

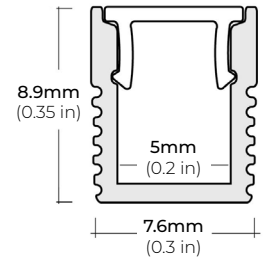

RECESSED PROFILES

ALP-30R

LENGTHS 49" | 84" | 98"
LENS Frosted
FINISH White | Black | Silver

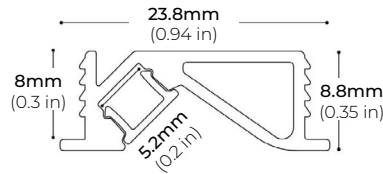

* For more compatible profiles, visit corelightingusa.com

LSM-35TN

3.0W INDOOR 5MM WIDE FLEXIBLE LED STRIP

COMPATIBLE TRANSFORMERS

PSDL SERIES TRIAC DIMMABLE

PSDL-30W-24V	CLASS 2	6.5" X 3.63" X 1.03"
PSDL-60W-24V	CLASS 2	7.4" X 3.63" X 1.03"
PSDL-96W-24V	CLASS 2	8.67" X 3.67 X 1.62"
PSDL-150W-24V		8.67" X 3.67" X 1.62"
PSDL-192W-24V		10.25" X 4.06" X 1.82"
PSDL-200W-24V		10.25" X 4.06" X 1.82"
PSDL-288W-24V		10.25" X 4.06" X 1.82"
PSDL-300W-24V		10.25" X 4.06" X 1.82"

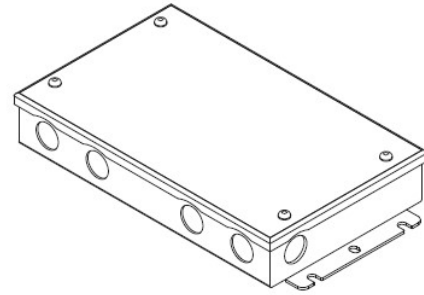

PSDH SERIES HIGH PERFORMANCE MAGNETIC LOW VOLTAGE (MLV)

PSDH-48W-24V	CLASS 2	11.25" X 3.37" X 3.25"
PSDH-96W-24V	CLASS 2	11.25" X 3.37" X 3.25"
PSDH-288W-24V	CLASS 2	14.25" X 8.43" X 4.43"

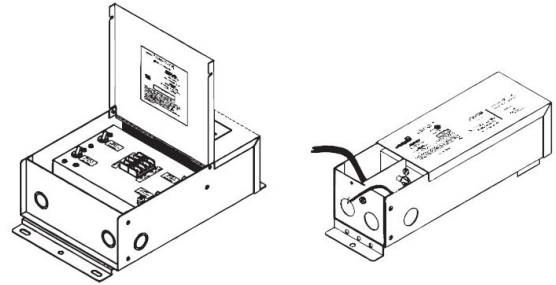

PSRX SERIES 4-IN-1 DIMMING DRIVER

PSRX-30W-24V	CLASS 2	6.5" X 3.72" X 1.57"
PSRX-60W-24V	CLASS 2	7.4" X 3.72" X 1.57"
PSRX-96W-24V	CLASS 2	8.66" X 3.72" X 1.57"
PSRX-150W-24V		10.24" X 4.13" X 1.77"
PSRX-192W-24V	CLASS 2	11" X 4" X 1.82"
PSRX-200W-24V		10.24" X 4.13" X 1.77"
PSRX-288W-24V	CLASS 2	11.85" X 4.25" X 1.82"
PSRX-300W-24V		10.94" X 4.33" X 1.77"

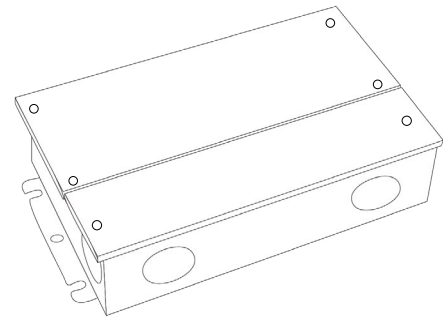

PSVT SERIES 0-10V DIMMING DRIVER

PSVT-60W-24V	CLASS 2	7.4" X 3.72" X 1.57"
PSVT-96W-24V	CLASS 2	8.66" X 3.72" X 1.57"
PSVT-200W-24V		10.24" X 4.13" X 1.77"
PSVT-288W-24V	CLASS 2	11.85" X 4.25" X 1.81"
PSVT-300W-24V		10.94" X 4.33" X 1.77"

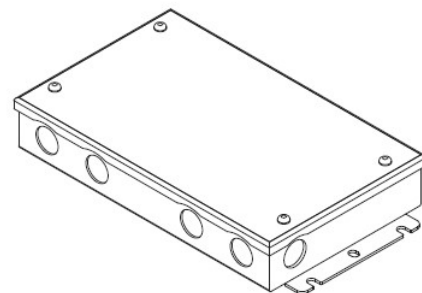

LSM-35TN

3.0W INDOOR 5MM WIDE FLEXIBLE LED STRIP

COMPATIBLE TRANSFORMERS

PSDE SERIES

0-10V DIMMING W/ JUNCTION BOX

PSDE-60W-24V-010-JB	CLASS 2	12.1" X 2.36" X 1.4"
PSDE-96W-24V-010-JB	CLASS 2	12.1" X 2.36" X 1.4"

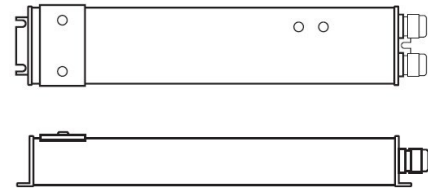

LUTRON 1%

3-WIRE DIMMING

L3DA4U1UKL-CV240	CLASS 2	4.0" X 1.5" X 4.0"
------------------	---------	--------------------

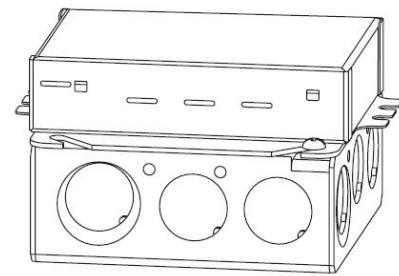

LUTRON 1%

PSDE-96W-24V-ECO	CLASS 2	10.5" X 3.0" X 2.0"
------------------	---------	---------------------

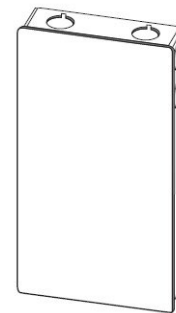

COMPATIBLE NON-DIMMING DRIVERS

PSHK SERIES

NON-DIMMING CONSTANT VOLTAGE WITH JUNCTION BOX

PSHK-30W-24V	CLASS 2	6.5" X 3.6" X 1.02"
PSHK-60W-24V	CLASS 2	7.4" X 3.62" X 1.02"
PSHK-96W-24V	CLASS 2	8.66" X 3.66" X 1.61"
PSHK-150W-24V		10.24" X 4.06" X 1.81"
PSHK-200W-24V		10.24" X 4.06" X 1.81"
PSHK-288W-24V	CLASS 2	11.85" X 4.25" X 1.82"
PSHK-300W-24V		10.24" X 4.25" X 1.81"

