

NOVA

INDOOR SUSPENDED LED LUMINAIRE

Project _____
Location _____
Quote/ Ref # _____

The **NOVA** is an Architectural Grade LED luminaire made of premium aluminum, offering excellent thermal management for LED strips with higher wattages and extends the total life of your lighting system. Manufactured with a patented frosted diffuser for maximum lumen output and wide beam distribution, this fixture also protects LED's from dust and other undesirable elements, which can shorten the lifetime of the LED.



SPECIFICATIONS

TYPE	Suspended
INPUT VOLTAGE	24V
WATTAGE	5W/ 6W/ 7W
LUMEN OUTPUT	500 ~ 750 Lm/ Ft. (30K)
COLOR TEMPERATURE	27K/ 30K/ 35K/ 40K/ 50K/ 60K/ RD/ GN/BL/ AM/ PK/ YW/ RGB27K/ RGB30K/ RGB40K/ RGB
LENS OPTION	Frosted
AVAILABLE LENGTHS	48 in./ 96 in.
DIMMING	0-10, DALI, and DMX
FINISH	Anodized Silver
TRANSFORMER	Remote
LENS (INCLUDED)	NOVA-LN

FEATURES

- Customizable
- Durable, military grade aluminum
- Protects LED systems from dust and other elements
- Dissipates heat from LED, prolonging its lifetime

LUMENS

TYPE	W/ FT.	LM/ FT.
L1	5W/ Ft	500
L2	6W/ Ft	620
L3	7W/ Ft	750

*Power supplies available in 120V and 277 options



MODEL	LENGTH	WATTAGE	COLOR TEMP			DIMMING
NOVA	4 4 Ft.	L1 5W	27K 2700K	RD* Red	RGBW27K RGB+27K	D10 0-10V
	8 8 ft.	L2 6W	30K 3000K	GN* Green	RGBW30K RGB+30K	DALI DALI
	PF Custom Length	L3 7W	35K 3500K	BL Blue	RGBW40K RGB+40K	DMX DMX
		40K 4000K	AM* Amber	RGB RGB		
		50K 5000K	PK* Pink			
		60K 6000K	YW* Yellow			
* Custom length per FT. (8Ft. Max)			* Available only in 6W			* DMX controllers and decoders sold separately

NOVA

INDOOR SUSPENDED LED LUMINAIRE

DIMENSIONS

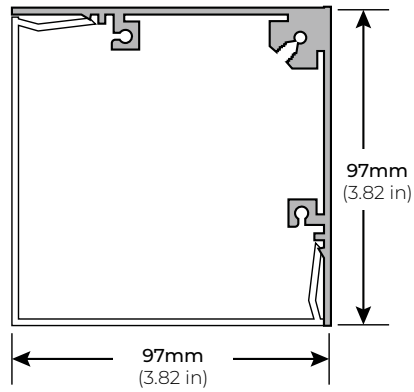

MOUNTING ACCESSORIES

ALP-CS12
EUROPEAN CABLE SUSPENSION

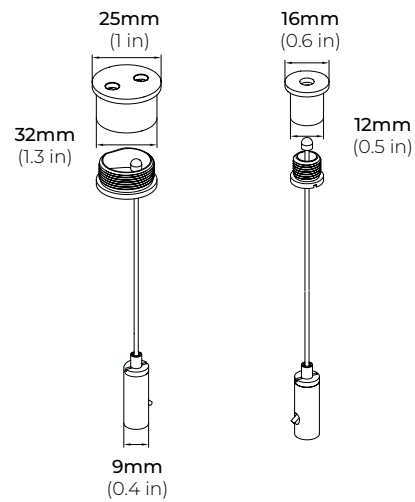

INDOOR SUSPENDED LED LUMINAIRE

SUSPENSION KIT ACCESSORIES

POWER FEED KIT

ALP-CF-WH
WHITE POWER FEED KIT

ALP-CF-BK
BLACK POWER FEED KIT

* INCLUDED WITH ALP-CS12 MOUNTING OPTION

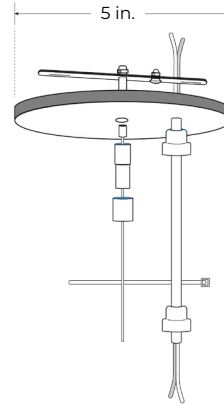

2" NON-POWER FEED KIT

ALP-CSB-WH-2
2" WHITE FEED KIT

ALP-CSB-BK-2
2" BLACK FEED KIT

* INCLUDED WITH ALP-CS12 MOUNTING OPTION

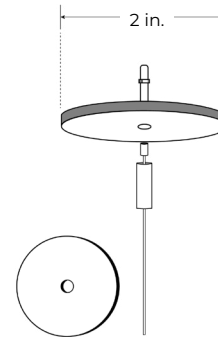

5" NON-POWER FEED KIT

ALP-CSB-WH-5
5" WHITE FEED KIT

ALP-CSB-BK-5
5" BLACK FEED KIT

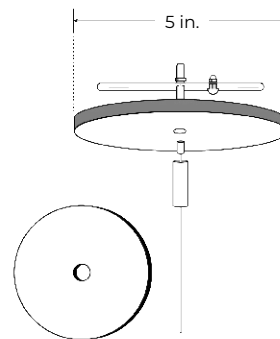

INDOOR SUSPENDED LED LUMINAIRE

DMX CONTROLLERS

RGB CT600

MULTI-FUNCTION RGBW WALL CONTROLLER

INPUT VOLTAGE 5V DC, 1A
OUTPUT SIGNAL RF 2.4GHZ + DMX512
CONTROL 4 ZONES
COLOR OPTIONS Black/ White
WORKING TEMP -20°C ~ 40°C
DIMENSIONS LxWxH (5.19"x7.08"x1.38")

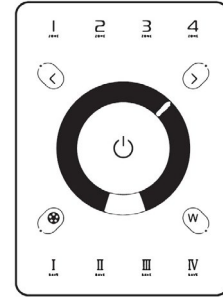

RGB-SCW4

WiFi DMX WALL CONTROLLER

INPUT VOLTAGE 5 - 10V DC, 06A
OUTPUT SIGNAL DMX512 (x2)
PROGRAMMABILITY PC/ MAC
COLOR OPTIONS Black/ White
CONNECTIONS USB/ 8dry contact ports/ Open drain output (for relay)
MEMORY Built-In Flash
WORKING TEMP -10°C ~ 45°C
DIMENSIONS LxWxH (5.75"x4.17"x0.43")

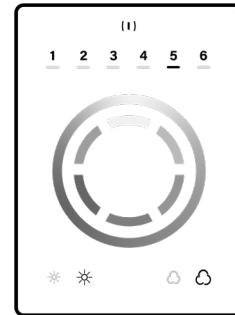

RGB-SDE3

WiFi DMX WALL CONTROLLER

INPUT VOLTAGE 6V DC, 0.6A
OUTPUT SIGNAL DMX512 (x2)
PROGRAMMABILITY PC/ MAC/ Tablet/ Smartphone
COLOR OPTIONS Black/ White
CONNECTIONS USB/ Ethernet/ RS232/ CLock/ 8dry contact ports/ 5V output relay
MEMORY MicroSD Card
WORKING TEMP -20°C ~ 40°C
DIMENSIONS LxWxH (5.75"x4.17"x0.43")

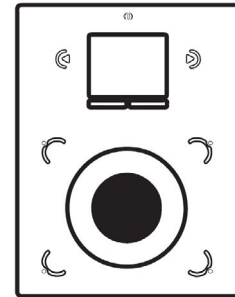

INDOOR SUSPENDED LED LUMINAIRE

DMX DECODERS

RGB-DMX-4C-RJ45 4-CHANNEL DMX DECODER

INPUT VOLTAGE 12V-24V DC
OUTPUT CURRENT 8A X 4CH
OUTPUT WATTAGE 60W(12V), 120W(24V)
OUTPUT CHANNELS 4
DIMENSIONS LxWxH (6.5"x2.38"x1.27")

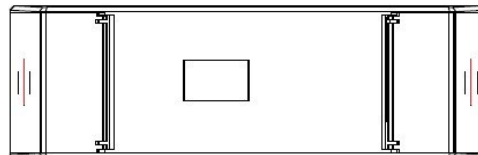

RGB-DMX-5C-XLR 5-CHANNEL DMX DECODER

INPUT VOLTAGE 12V-24V DC
OUTPUT CURRENT 8A X 5CH
OUTPUT WATTAGE 5 x (96W ~ 192W)
OUTPUT CHANNELS 5
DIMENSIONS LxWxH (6.45"x2.87"x1.5")

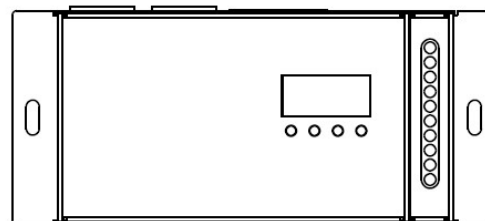

INDOOR SUSPENDED LED LUMINAIRE

NON-DMX CONTROLLERS

RGB-CT550

RGBW WIRELESS RECEIVER / CONTROLLER SYSTEM

REMOTE DISTANCE 100 Ft. (Line of Sight)
FREQUENCY 2.4 GHz
DIMENSIONS LxWxH (6.38"x1.65"x0.59")
WEIGHT 0.44lbs.

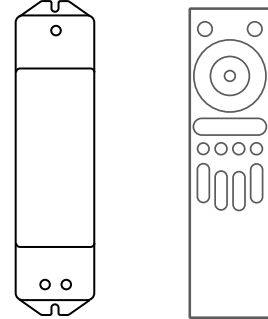

* RGB-CT500-RX
(Sold Separately)

RGB-CT550-RX

RGBW WIRELESS RECEIVER / CONTROLLER SYSTEM

INPUT VOLTAGE DC5V ~ DC24V
POWER CAPACITY 100W (5V) | 240W (12V) | 480W (24V)
OUTPUT CURRENT 5A per Channel (20A Total)
WORKING TEMP -30°C~55°C (-22°F~131°F)
DIMENSIONS LxWxH (6.89"x1.73"x1.18")

* RGB-CT500-RX (Sold Separately)

RGB-CT700

MASTER RGBW WIFI CONTROLLER

INPUT VOLTAGE 12-24V DC
OUTPUT TYPE Constant Voltage
POWER CAPACITY 288W (12V) | 384W (24V)
OUTPUT CURRENT 5A per Channel (20A Total)
WORKING TEMP -4°F (-20°C) ~ 122°F (50°C)
DIMENSIONS LxWxH (7 x1.8 x 0.8")

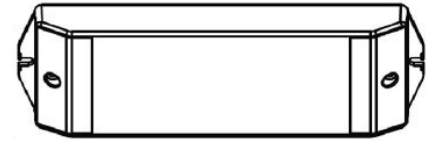

* Paired with RGB-CT705ZR (Sold Separately)

RGB-CT705ZR

SLAVE RGBW WIFI CONTROLLER

INPUT VOLTAGE 12-24V DC
OUTPUT TYPE Constant Voltage
POWER CAPACITY 288W (12V) | 384W (24V)
OUTPUT CURRENT 5A per Channel (20A Total)
WORKING TEMP -4°F (-20°C) ~ 122°F (50°C)
DIMENSIONS LxWxH (7 x0,63 x 0.71")

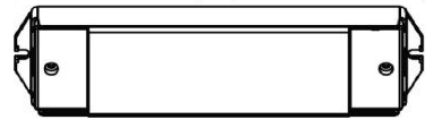

* Paired with RGB-CT700 (Sold Separately)

INDOOR SUSPENDED LED LUMINAIRE

NON-DMX CONTROLLERS (CONTINUED)

RGB-CT840 BLUETOOTH TOUCH PANEL WALL CONTROLLER

INPUT VOLTAGE	12-24V DC
ZONES	4
CONTROL MODE	RGB RGBW
WIRELESS PROTOCOL	Bluetooth 5.0 SIG Mesh
WORKING TEMP	-20°C ~ 55°C
DIMENSIONS	LxWxH (4.7"x3"x1.2")

** Paired with RGB-CT800-RC (Sold Separately)*



RGB-CT800-RC BLUETOOTH CONSTANT VOLTAGE LED RECEIVER

INPUT VOLTAGE	12V 24V
OUTPUT CURRENT	4Ax5CH / 5Ax4CH (20A Max)
POWER CAPACITY	240W (12V) 480W (24V)
PROGRAMMABILITY	iOS and Android
WORKING TEMP	-20°C ~ 55°C
DIMENSIONS	LxWxH (6.9 x1.7 x1.2")

** Paired with RGB-CT840 (Sold Separately)*

