

LSM-75HF

7.0W HIGH-OUTPUT INDOOR FLEXIBLE LED STRIP

Project _____
Location _____
Quote/ Ref # _____

LSM-75HF High Output Flexible LED strip is designed to produce more than 830 Lumens at 7.0 Watts per foot. This field cuttable LED strip features a low profile design that allows it to be attached almost anywhere. It is suitable for most common lighting applications. The LSM-75HF produces a 120° light beam spread and is available in different color temperatures to fit your specific needs. UL listed



SPECIFICATIONS

INPUT VOLTAGE	24V DC
POWER CONSUMPTION	7W/Ft.
NO. OF LEDS	72 LEDs per Ft.
LUMEN OUTPUT	830 Lm/Ft. (35K)
CRI	95+
COLOR TEMPERATURE	27K / 30K / 35K / 40K / 50K
DIMMING	MLV, ELV, 0-10 and TRIAC
MAXIMUM RUN LENGTH	20 Ft.
CUTTABLE	Every 1.31 in (33.4mm)
BINNING	1.5 Step Macadam Elipse
OPERATING TEMPERATURE	-40°F (-40°C) ~ +140°F (+60°C)
BEAM ANGLE	120°
IP RATING	IP45 dry location (Indoor)
CERTIFICATIONS	UL Listed, TITLE 24 JA8
LUMEN MAINTENANCE	50,000 Hrs.

LUMENS

CCT	LM/ FT	CRI	R9	R13
2700K	770	96	96	97
3000K	802	97	95	98
3500K	830	96	98	97
4000K	865	97	98	98

*Approved for closet / storage space installation per NEC 410.16(A)(3) and 410.16(C)(5)



MODEL	COLOR TEMP	LENGTH	VOLTAGE	PROFILE
LSM75HF	27K 2700K	16 16 Ft.	24 24V DC	<i>See Page 3 for compatible profiles.</i>
	30K 3000K	100 100 Ft.		
	35K 3500K	1XX per Ft.		
	40K 4000K			
	50K 5000K			
		*1 = Custom length per FT. (Cuttable every 1.31")		* Custom color finishes require powder coating. Allow 7 days leads time.

LSM-75HF

7.0W HIGH-OUTPUT INDOOR FLEXIBLE LED STRIP

DIMENSIONS

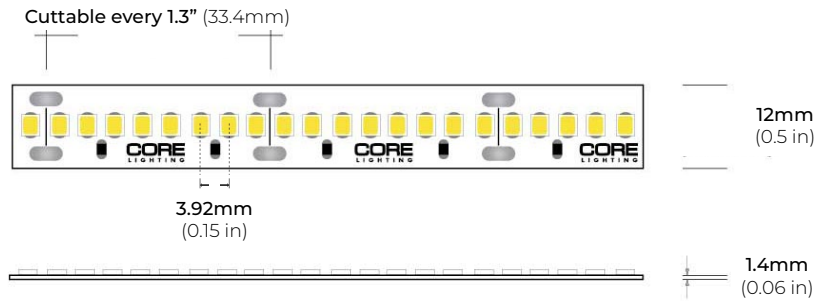

COMPATIBLE CONNECTORS

For more information about connector-profile compatibility, visit corelightingusa.com/tape-light-accessories.

HP PRO CONNECTORS

QUICK CONNECT SNAP-ON
(0.96" X 0.67" X 0.31")

LSA-HW24-HPX12 24" HARDWIRE CONNECTOR
LSA-HW60-HPX12 60" HARDWIRE CONNECTOR

LSA-EX3-HPX12 3" LINK
LSA-EX8-HPX12 8" LINK
LSA-EX24-HPX12 24" LINK

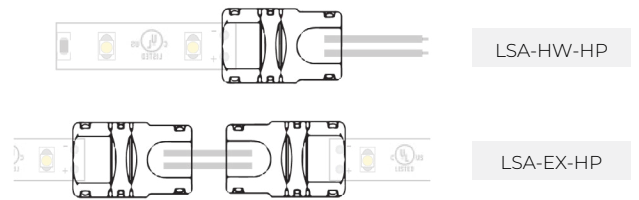

LSM-75HF

7.0W HIGH-OUTPUT INDOOR FLEXIBLE LED STRIP

COMPATIBLE ALUMINUM PROFILES

SURFACE PROFILES

ALU-SF

LENGTHS 39.4" | 78.9" | 84" | 98"
LENS Clear, Frosted
FINISH Black | Silver

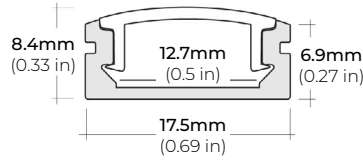

ALU-DS100

LENGTHS 39" | 78" | 84"
LENS Clear, Frosted
FINISH Silver

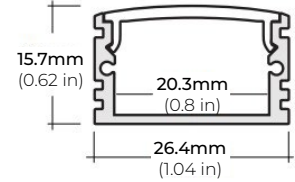

ALP-70

LENGTHS 49.25" | 84" | 98.5"
LENS Frosted
FINISH White | Black | Silver

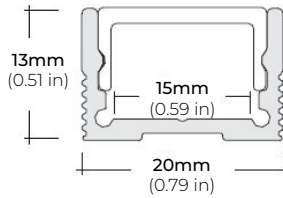

ALP-75C (CORNER)

LENGTHS 49" | 84" | 98"
LENS Frosted
FINISH Black | Silver

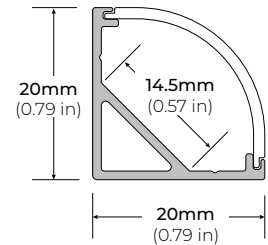

ALP-80

LENGTHS 49.25" | 98.5"
LENS Frosted
FINISH Silver

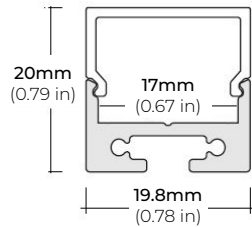

ALP-102

LENGTHS 49" | 98"
LENS Frosted, Black, Asymmetric, Double Asymmetric
FINISH Black | Silver | White

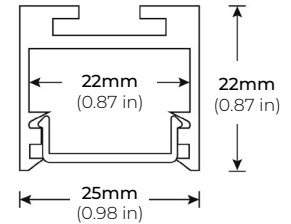

ALP-130

LENGTHS 49" | 84" | 98"
LENS Frosted
FINISH Silver | Black

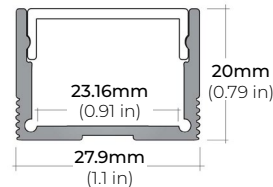

ALP-140

LENGTHS 48" | 98"
LENS Frosted
FINISH Silver

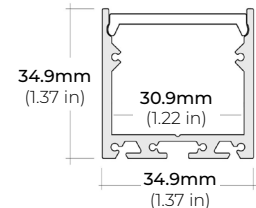

ALP-150LX

LENGTHS 49" | 98"
LENS Frosted
FINISH White | Black

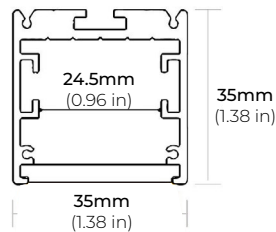

ALP-160

LENGTHS 49" | 98"
LENS Frosted
FINISH Silver

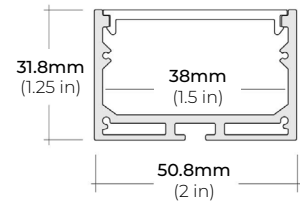

* For more compatible profiles, visit corelightingusa.com

RECESSED PROFILES

ALP-20R

LENGTHS 49.25" | 98.5"
LENS Frosted
FINISH White | Black | Silver

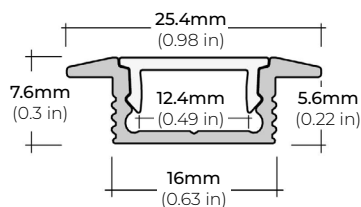

ALP-70R

LENGTHS 48" | 98"
LENS Frosted
FINISH Black | Silver

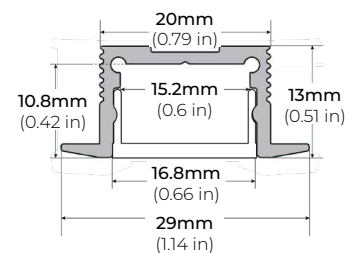

* For more compatible profiles, visit corelightingusa.com

LSM-75HF

7.0W HIGH-OUTPUT INDOOR FLEXIBLE LED STRIP

COMPATIBLE TRANSFORMERS

PSDL SERIES TRIAC DIMMABLE

PSDL-30W-24V	CLASS 2	6.5" X 3.63" X 1.03"
PSDL-60W-24V	CLASS 2	7.4" X 3.63" X 1.03"
PSDL-96W-24V	CLASS 2	8.67" X 3.67 X 1.62"
PSDL-150W-24V		8.67" X 3.67" X 1.62"
PSDL-192W-24V	CLASS 2	10.25" X 4.06" X 1.82"
PSDL-200W-24V		10.25" X 4.06" X 1.82"
PSDL-288W-24V	CLASS 2	10.25" X 4.06" X 1.82"
PSDL-300W-24V		10.25" X 4.06" X 1.82"

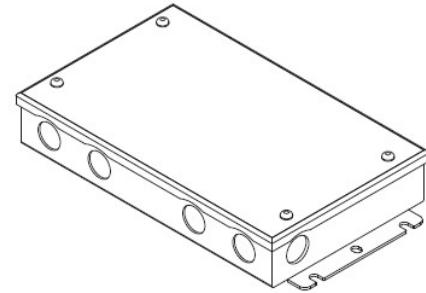

PSDH SERIES HIGH PERFORMANCE MAGNETIC LOW VOLTAGE (MLV)

PSDH-48W-24V	CLASS 2	11.25" X 3.37" X 3.25"
PSDH-96W-24V	CLASS 2	11.25" X 3.37" X 3.25"
PSDH-288W-24V	CLASS 2	14.25" X 8.43" X 4.43"

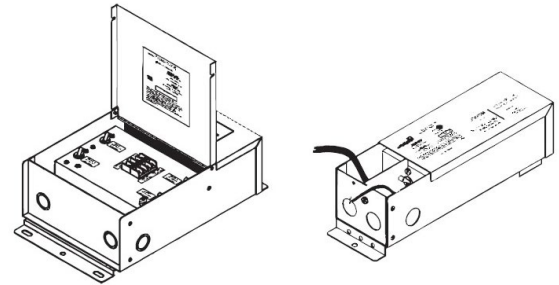

PSRX SERIES 4-IN-1 DIMMING DRIVER

PSRX-30W-24V	CLASS 2	6.5" X 3.72" X 1.57"
PSRX-60W-24V	CLASS 2	7.4" X 3.72" X 1.57"
PSRX-96W-24V	CLASS 2	8.66" X 3.72" X 1.57"
PSRX-150W-24V		10.24" X 4.13" X 1.77"
PSRX-192W-24V	CLASS 2	11" X 4" X 1.82"
PSRX-200W-24V		10.24" X 4.13" X 1.77"
PSRX-288W-24V	CLASS 2	11.85" X 4.25" X 1.82"
PSRX-300W-24V		10.94" X 4.33" X 1.77"

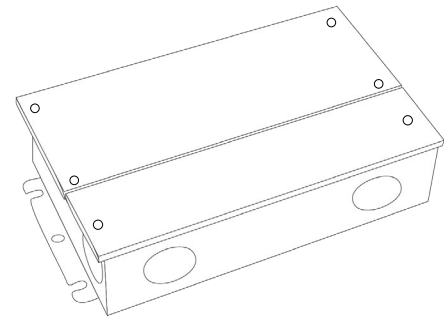

PSVT SERIES 0-10V DIMMING DRIVER

PSVT-60W-24V	CLASS 2	7.4" X 3.72" X 1.57"
PSVT-96W-24V	CLASS 2	8.66" X 3.72" X 1.57"
PSVT-200W-24V		10.24" X 4.13" X 1.77"
PSVT-288W-24V	CLASS 2	11.85" X 4.25" X 1.81"
PSVT-300W-24V		10.94" X 4.33" X 1.77"

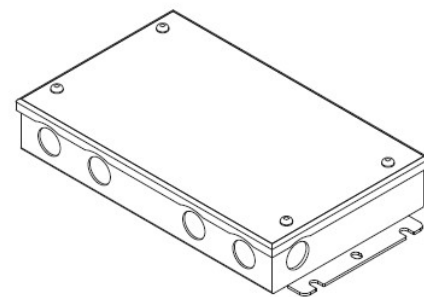

LSM-75HF

7.0W HIGH-OUTPUT INDOOR FLEXIBLE LED STRIP

COMPATIBLE TRANSFORMERS

PSDE SERIES
0-10V DIMMING W/ JUNCTION BOX

PSDE-60W-24V-010-JB	CLASS 2	12.1" X 2.36" X 1.4"
PSDE-96W-24V-010-JB	CLASS 2	12.1" X 2.36" X 1.4"

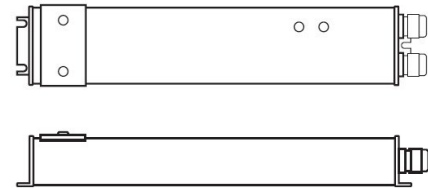

LUTRON 1%
3-WIRE DIMMING

L3DA4U1UKL-CV240	CLASS 2	4.0" X 1.5" X 4.0"
------------------	---------	--------------------

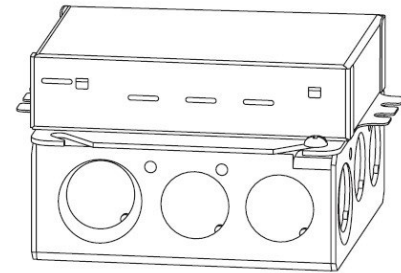

LUTRON 1%

PSDE-96W-24V-ECO	CLASS 2	10.5" X 3.0" X 2.0"
------------------	---------	---------------------

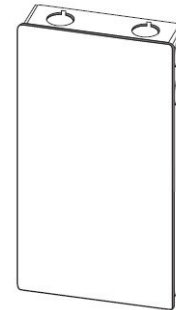

COMPATIBLE NON-DIMMING DRIVERS

PSHK SERIES
NON-DIMMING CONSTANT VOLTAGE WITH JUNCTION BOX

PSHK-30W-24V	CLASS 2	6.5" X 3.6" X 1.02"
PSHK-60W-24V	CLASS 2	7.4" X 3.62" X 1.02"
PSHK-96W-24V	CLASS 2	8.66" X 3.66" X 1.61"
PSHK-150W-24V		10.24" X 4.06" X 1.81"
PSHK-200W-24V		10.24" X 4.06" X 1.81"
PSHK-288W-24V	CLASS 2	11.85" X 4.25" X 1.82"
PSHK-300W-24V		10.24" X 4.25" X 1.81"

