

LSE-150

1.5W ECO SERIES INDOOR FLEXIBLE LED STRIP

Project _____
Location _____
Quote/ Ref # _____

LSE-150 eco series is an LED light source suitable for indoor lighting applications. At 1.5 Watts per foot, this LED strip provides 109 Lumens and is offered in a low profile design allowing it to be installed almost anywhere. Rated to last 35,000 hours, it is bright, eco-friendly, fully dimmable and virtually produces no heat.



SPECIFICATIONS

INPUT VOLTAGE	12V 24V DC
POWER CONSUMPTION	1.5W per Ft.
LEDS/ FT.	18 LEDS per Ft.
LUMEN OUTPUT	109 Lumens per Ft.
CRI	90+
COLOR TEMPERATURE	27K/ 30K/ 40K/ 50K
DIMMING	MLV, ELV, 0-10 and TRIAC
MAXIMUM RUN LENGTH	16 Ft. (12V) 20Ft. (24V)
CUTTABLE	Every 2 In. (12V) Every 4 In. (24V)
BINNING	1.5-Step MacAdam Elipse
OPERATING TEMPERATURE	-40°F(-40°C)~+140°F(+60°C)
BEAM ANGLE	120°
IP RATING	IP54 dry location (indoor)
CERTIFICATIONS	UL Listed
LUMEN MAINTENANCE	35,000 Hrs.

FEATURES

- 1.5W per Foot
- 109 Lumens
- 90+ CRI
- Field cuttable
- Suitable for accent or ambient lighting
- Multiple CCT options available
- UL Listed



MODEL	COLOR TEMP	LED LENGTH	VOLTAGE	PROFILE
LSE150	27K 2700K	16 16 Ft.	12 12V	See Page 3 - 4 for compatible profiles.
	30K 3000K	100 100 Ft.	24 24V	
	40K 4000K			
	50K 5000K			

* Custom color finishes require powder coating. Allow 7 days leads time.

LSE-150

1.5W ECO SERIES INDOOR FLEXIBLE LED STRIP

DIMENSIONS

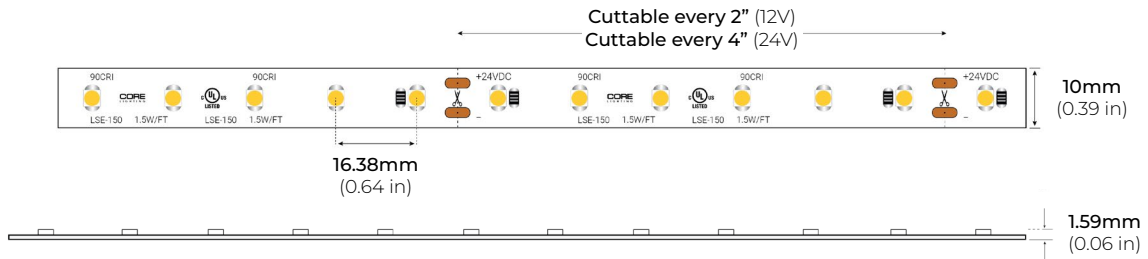

COMPATIBLE CONNECTORS

For more information about connector-profile compatibility, visit corelightingusa.com/tape-light-accessories.

HP PRO CONNECTORS

QUICK CONNECT SNAP-ON
(0.96" X 0.57" X 0.3")

- LSA-HW8-HP 8" HARDWIRE CONNECTOR
- LSA-HW24-HP 24" HARDWIRE CONNECTOR
- LSA-HW60-HP 60" HARDWIRE CONNECTOR
- LSA-HW120-HP 120" HARDWIRE CONNECTOR

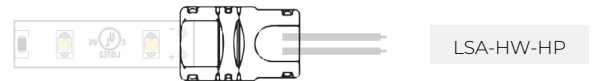

- LSA-EX3-HP 3" LINK
- LSA-EX8-HP 8" LINK
- LSA-EX24-HP 24" LINK

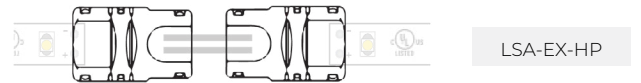

- LSA-MC-HP MINI COUPLING



- LSA-DC24-HP 24" DC CONNECTOR

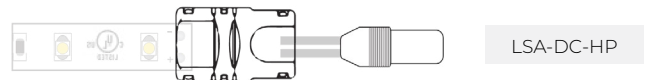

LSA-TB

SOLDERLESS LED STRIP/ WIRE BLOCK CONNECTOR

- LSA-TB-HWC-4A 4 AMP MAX HARDWIRE CONNECTOR
53W MAX (24V)
(0.45" X 0.48" X 0.31")



- LSA-TB-MC-4A 4 AMP MAX STRIP TO STRIP CONNECTOR
53W MAX (24V)
(0.45" X 0.48" X 0.31")



LSE-150

1.5W ECO SERIES INDOOR FLEXIBLE LED STRIP

COMPATIBLE ALUMINUM PROFILES

SURFACE PROFILES

ALU-SF

LENGTHS 39" | 78" | 84" | 98"
LENS Clear, Frosted
FINISH Black | Silver

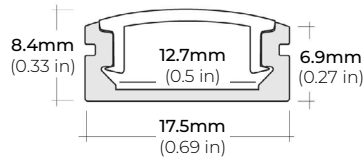

ALU-DS100

LENGTHS 39" | 78" | 84"
LENS Clear, Frosted
FINISH Silver

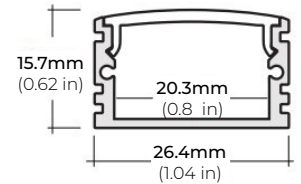

ALP-20

LENGTHS 49" | 84" | 98"
LENS Frosted
FINISH White | Black | Silver

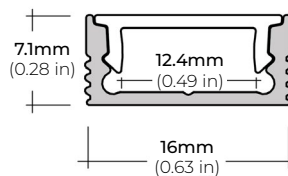

ALP-35

LENGTHS 49" | 98"
LENS Frosted
FINISH White | Black | Silver

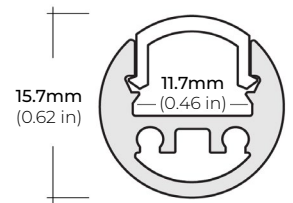

ALP-50C (CORNER)

LENGTHS 48" | 84" | 98"
LENS Frosted
FINISH White | Black | Silver

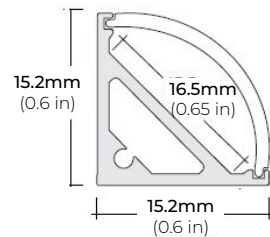

ALP-70

LENGTHS 49" | 84" | 98"
LENS Frosted
FINISH Black | Silver

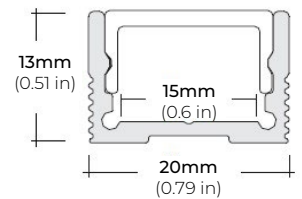

ALP-80

LENGTHS 49" | 98"
LENS Frosted
FINISH Silver

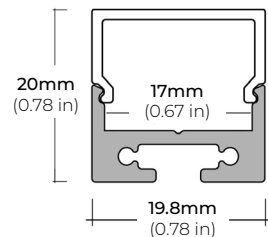

ALP-100C (CORNER)

LENGTHS 48" | 98"
LENS Frosted
FINISH Silver

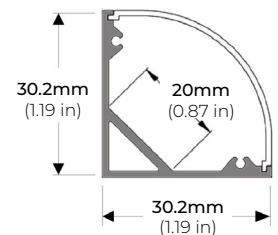

ALP-100K-98 (CORNER)

LENGTHS 48" | 98"
LENS Frosted
FINISH Silver

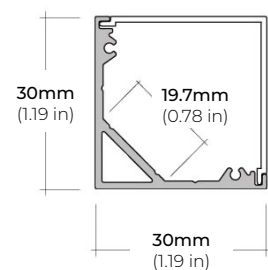

ALP-102

LENGTHS 49" | 98"
LENS Frosted, Black, Asymmetric, Double Asymmetric
FINISH Black | Silver | White

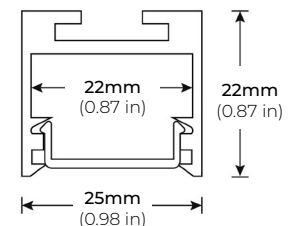

* For more compatible profiles, visit corelightingusa.com

LSE-150

1.5W ECO SERIES INDOOR FLEXIBLE LED STRIP

UPDATED: 04.14.26

COMPATIBLE ALUMINUM PROFILES

RECESSED PROFILES

ALP-70R

LENGTHS 48" | 96"
LENS Frosted
FINISH Black | Silver

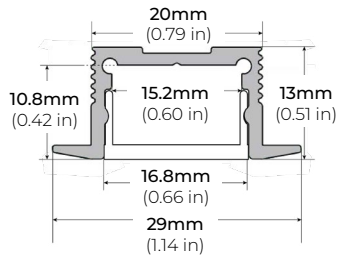

ALP-102R

LENGTHS 49" | 98"
LENS Frosted, Black, Asymmetric, Double Asymmetric
FINISH Silver

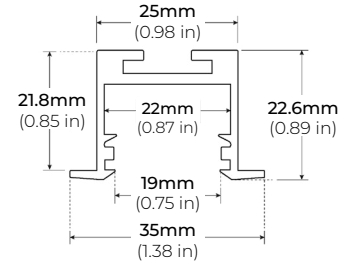

* For more compatible profiles, visit corelightingusa.com

TRIMLESS PROFILES

ALP-1300TL

LENGTHS 48" | 96"
LENS Clear, Frosted
FINISH White

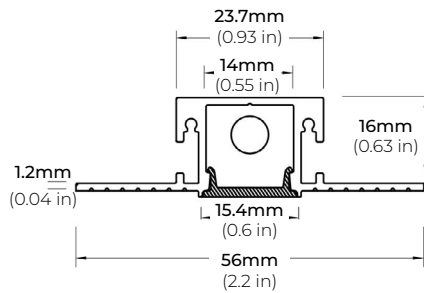

ALP-2300TL

LENGTHS 48" | 96"
LENS Frosted
FINISH White

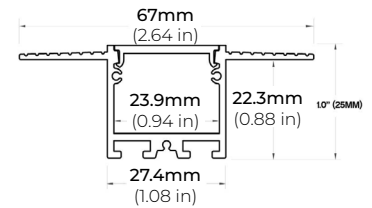

ALP-2400TL

LENGTHS 48" | 96"
LENS Clear, Frosted
FINISH White

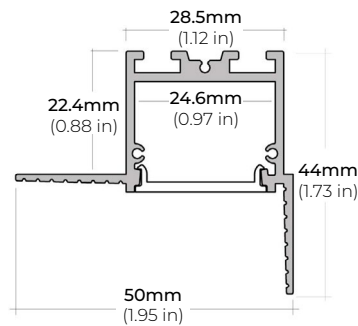

ALP-2700TL

LENGTHS 48" | 96"
LENS Frosted
FINISH White

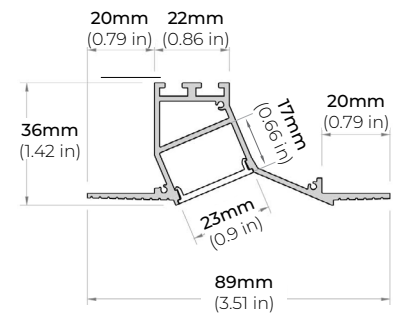

* For more compatible profiles, visit corelightingusa.com

LSE-150

1.5W ECO SERIES INDOOR FLEXIBLE LED STRIP

COMPATIBLE TRANSFORMERS

PSDL SERIES TRIAC DIMMABLE

PSDL-30W-12V	CLASS 2	6.5" X 3.63" X 1.58"
PSDL-60W-12V	CLASS 2	7.4" X 3.63" X 1.58"
PSDL-100W-12V	CLASS 2	8.67" X 3.67 X 1.62"
PSDL-150W-12V		10.25" X 4.06" X 1.82"
PSDL-200W-12V		10.25" X 4.06" X 1.82"
PSDL-300W-12V		10.25" X 4.06" X 1.82"

PSDL-30W-24V	CLASS 2	6.5" X 3.63" X 1.58"
PSDL-60W-24V	CLASS 2	7.4" X 3.63" X 1.58"
PSDL-96W-24V	CLASS 2	8.67" X 3.67 X 1.62"
PSDL-150W-24V		10.25" X 4.06" X 1.82"
PSDL-192W-24V	CLASS 2	11" X 4" X 1.82"
PSDL-200W-24V		10.25" X 4.06" X 1.82"
PSDL-288W-24V	CLASS 2	11.85" X 4.25" X 1.82"
PSDL-300W-24V		10.25" X 4.06" X 1.82"

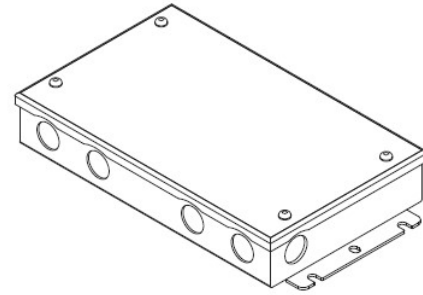

PSDH SERIES HIGH PERFORMANCE MAGNETIC LOW VOLTAGE (MLV)

PSDH-48W-24V	CLASS 2	11.25" X 3.38" X 3.38"
PSDH-96W-24V	CLASS 2	11.25" X 3.38" X 3.37"
PSDH-288W-24V	CLASS 2	14.25" X 8.43" X 4.43"

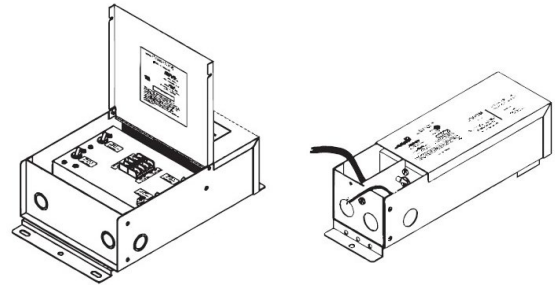

PSRX SERIES 4-IN-1 DIMMING DRIVER W/ JUNCTION BOX

PSRX-30W-12V-UNV	CLASS 2	6.5" X 3.72" X 1.57"
PSRX-60W-12V-UNV	CLASS 2	7.4" X 3.72" X 1.57"
PSRX-150W-12V-UNV		10.24" X 4.13" X 1.77"
PSRX-30W-24V-UNV	CLASS 2	6.5" X 3.7" X 1.57"
PSRX-60W-24V-UNV	CLASS 2	7.4" X 3.72" X 1.57"
PSRX-96W-24V-UNV	CLASS 2	8.66" X 3.72" X 1.57"
PSRX-150W-24V-UNV		10.24" X 4.13" X 1.77"
PSRX-200W-24V-UNV		10.24" X 4.13" X 1.77"
PSRX-300W-24V-UNV		10.94" X 4.33" X 1.77"

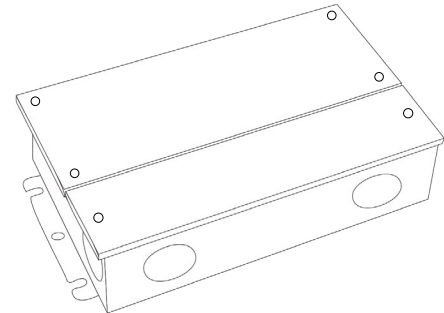

LSE-150

1.5W ECO SERIES INDOOR FLEXIBLE LED STRIP

COMPATIBLE TRANSFORMERS

PSVT SERIES

0-10V DIMMING WITH JUNCTION BOX

PSVT-60W-24V-UNV-010	CLASS 2	7.4" X 3.72" X 1.57"
PSVT-96W-24V-UNV-010	CLASS 2	8.66" X 3.72" X 1.57"
PSVT-200W-24V-UNV-010		10.24" X 4.13" X 1.77"
PSVT-288W-24V-UNV-010	CLASS 2	11.85" X 4.25" X 1.81"
PSVT-300W-24V-UNV-010		10.94" X 4.33" X 1.77"

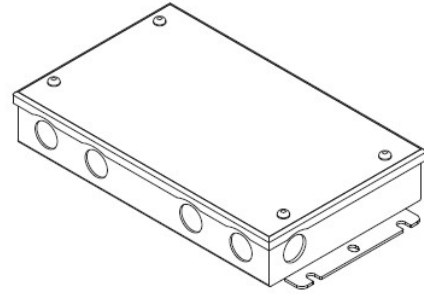

PSDE SERIES

0-10V DIMMING W/ JUNCTION BOX

PSDE-60W-24V-010-JB	CLASS 2	12.1" X 2.36" X 1.4"
PSDE-96W-24V-010-JB	CLASS 2	12.1" X 2.36" X 1.4"

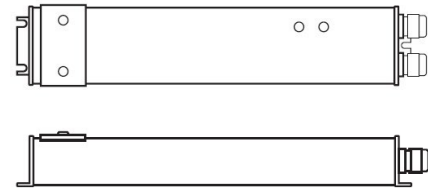

LUTRON 1%

3-WIRE DIMMING

L3DA4U1UKL-CV240	CLASS 2	4.89" X 4" X 2.62"
------------------	---------	--------------------

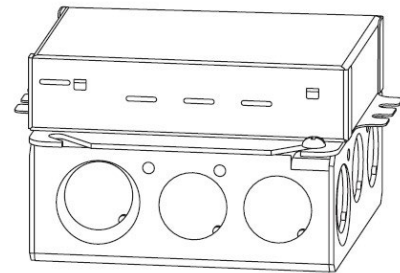

LUTRON 1%

3-WIRE DIMMING

PSDE-96W-24V-ECO	CLASS 2	10.5" X 3.0" X 2.0"
------------------	---------	---------------------

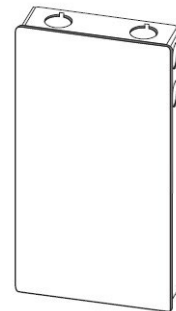

LSE-150

1.5W ECO SERIES INDOOR FLEXIBLE LED STRIP

COMPATIBLE NON-DIMMING DRIVERS

PSHK SERIES

NON-DIMMING CONSTANT VOLTAGE WITH JUNCTION BOX

PSHK-30W-24V	CLASS 2	6.5" X 3.6" X 1.02"
PSHK-60W-24V	CLASS 2	7.4" X 3.62" X 1.02"
PSHK-96W-24V	CLASS 2	8.66" X 3.66" X 1.61"
PSHK-150W-24V		10.24" X 4.06" X 1.81"
PSHK-200W-24V		10.24" X 4.06" X 1.81"
PSHK-288W-24V	CLASS 2	11.85" X 4.25" X 1.82"
PSHK-300W-24V		10.94" X 4.25" X 1.81"

