

LFO-90DB

7.6W DUAL BEND OPTIC LED STRIP

Project _____
Location _____
Quote/ Ref # _____

LFO-90DB is a 24V flexible indoor and outdoor optical LED strip. With its unique design, the LFO-90DB is able to bend horizontally or vertically, making it easy to create customized lighting arrangements. Its linear design and multiple angle options are ideal for creating a dramatic accent wall or simply adding a touch of warmth to your living space. Available in multiple color temperatures, this LED strip is the perfect choice for your decorative lighting needs.



SPECIFICATIONS

POWER CONSUMPTION	7.6W per Ft.
LUMEN OUTPUT	686 Lm/Ft.
CRI	90+
COLOR TEMPERATURE	27K/ 30K/ 40K
DIMMING/ CONTROL	MLV, ELV, 0-10 and TRIAC
MAXIMUM RUN LENGTH	16.4 Ft.
CUTTABLE	Every 9.84 in. (250mm)
OPERATING VOLTAGE	24V DC
OPERATING TEMPERATURE	-4°F (-20°C) to 113°F (45°C)
BEAM ANGLE	10°/ 15°/ 20°/ 25°/ 30°/ 40°/ 50°/ 25°x50°/ 45°x 30°
IP RATING	IP67
CERTIFICATIONS	CE, RoHS, UL Listed
LUMEN MAINTENANCE	50,000 Hrs.

FEATURES

- 7.6W/ Ft.
- 24V DC
- 90+ CRI
- Continuous Run up to 16.4 Ft.
- Flexible, Silicone encapsulated
- Dual Bend Capabilities
- CE, RoHS, UL Listed



MODEL	COLOR TEMP	OPTIC		LENGTH	VOLTAGE	POWER FEED	FEED LENGTH
LFO-90DB	27K 2700K	10 10°	40 40°	¹ XX per Ft.	24 24V DC	BF Bottom Feed	HW3 3 Ft. Power Feed
	30K 3000K	15 15°	50 50°			SFL Side Feed Left	HW10 10 Ft. Power Feed
	40K 4000K	20 20°	2550 25° x 50°			SFR Side Feed Right	HW15 15 Ft. Power Feed
	25 25°	4530 45° x 30°	EF End Feed				
	30 30°						

*1 = Custom length per FT. (cuttable every 9.84")

LFO-90DB

7.6W DUAL BEND OPTIC LED STRIP

DIMENSIONS

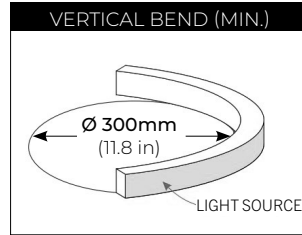
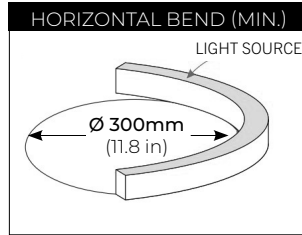
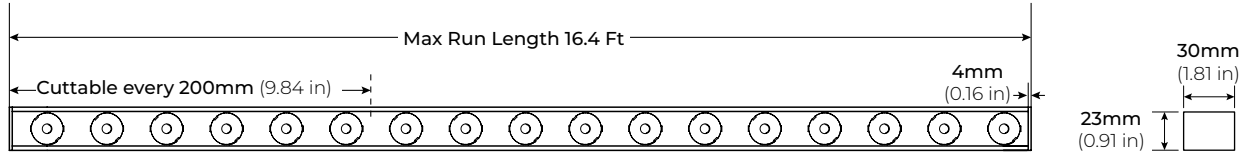

COMPATIBLE ACCESSORIES

LFO90-MB
ALUMINUM MOUNTING CLIP
50 X 34 X 26mm (L x W x H)

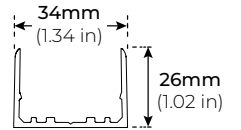
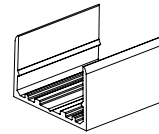

LFO90-AC39
ALUMINUM PROFILE
1000 X 34 X 26mm (L x W x H)

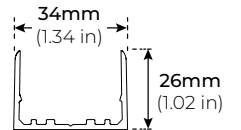
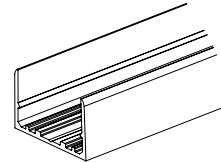

LFO90-BKT-ADJ
ADJUSTABLE BRACKET

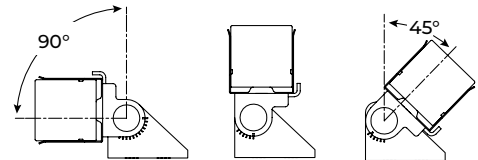

LFO-90DB-FX39
39" FLEXIBLE CHANNEL

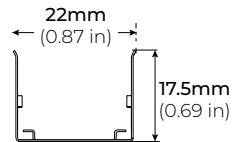
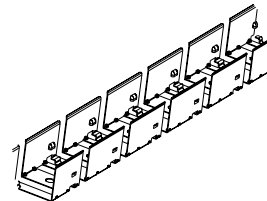

LFO-90DB

7.6W DUAL BEND OPTIC LED STRIP

OPTICS

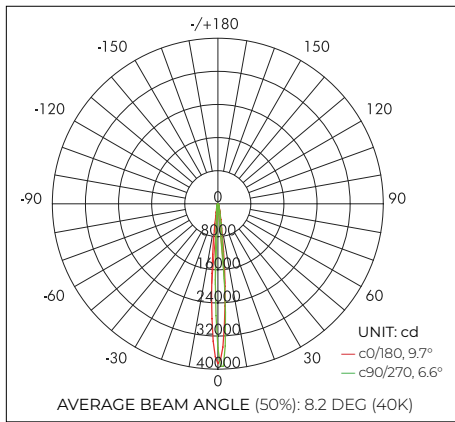

10°

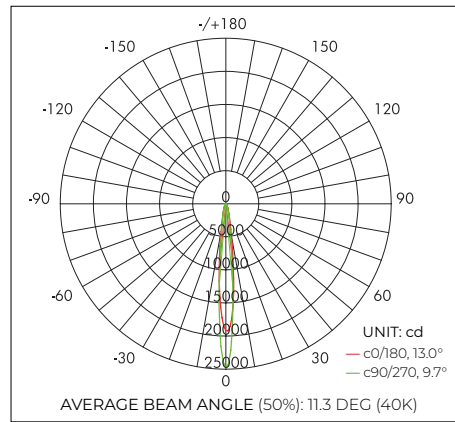

15°

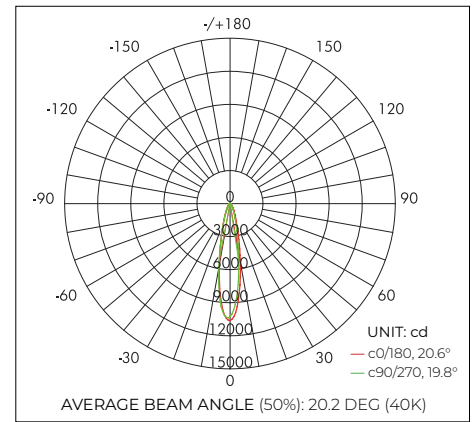

20°

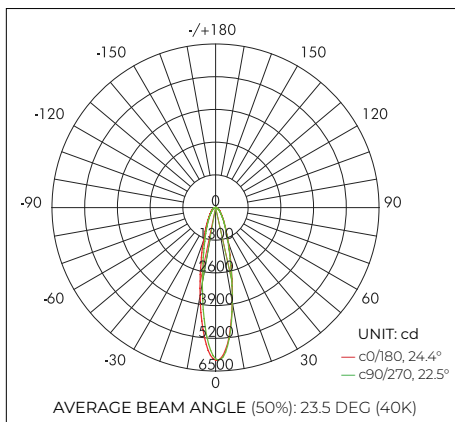

25°

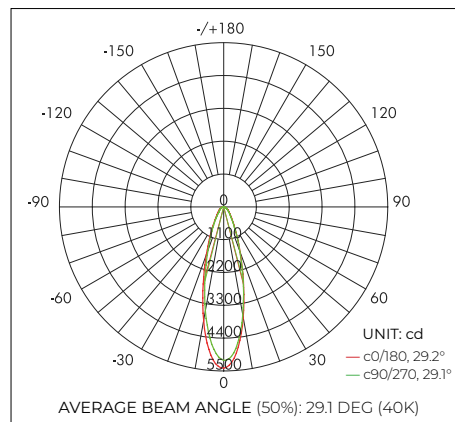

30°

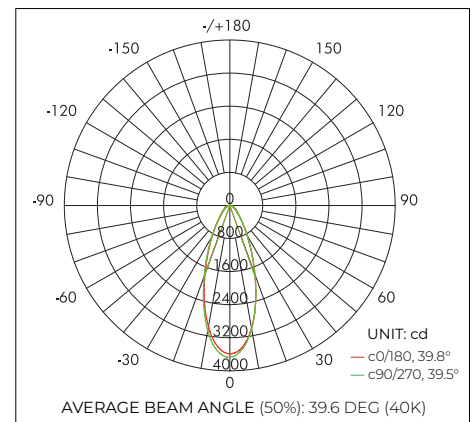

40°

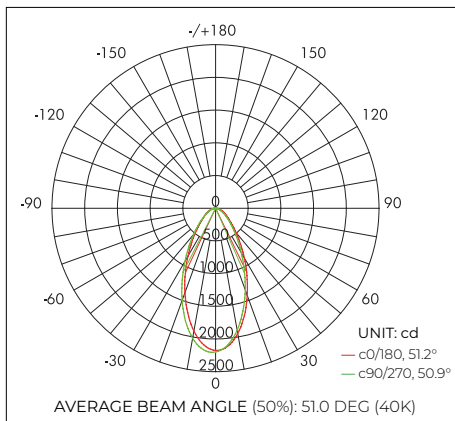

50°

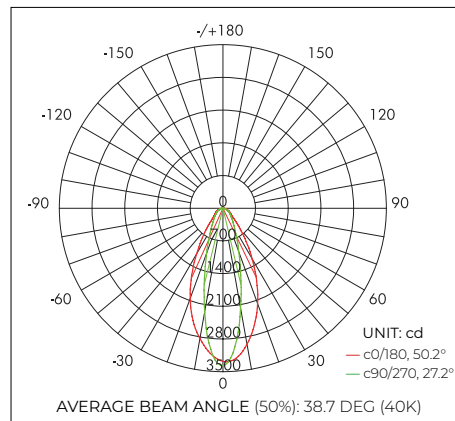

25° X 50°

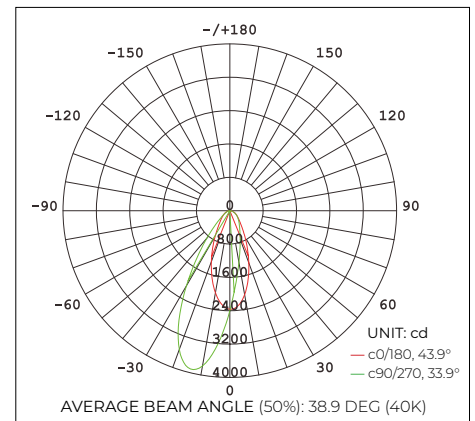

45° X 30°

LFO-90DB

7.6W DUAL BEND OPTIC LED STRIP

POWER FEED

BF
BOTTOM FEED



SFL
SIDE LEFT FEED

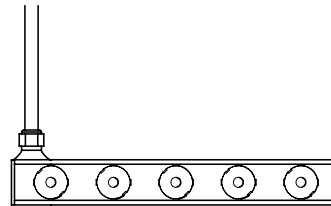

SFR
SIDE RIGHT FEED

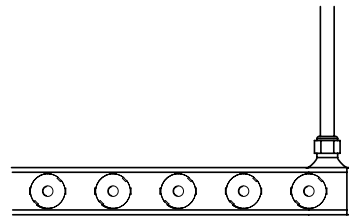

EF
END FEED



LFO-90DB

7.6W DUAL BEND OPTIC LED STRIP

LIGHT DISTRIBUTION

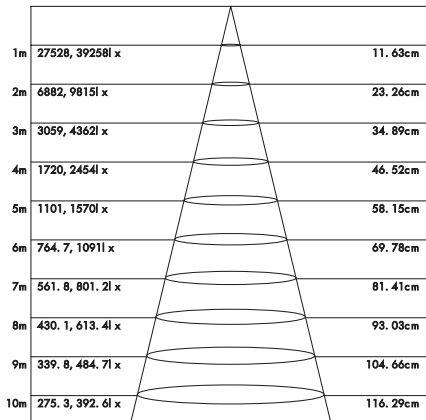

10°
(4000K)

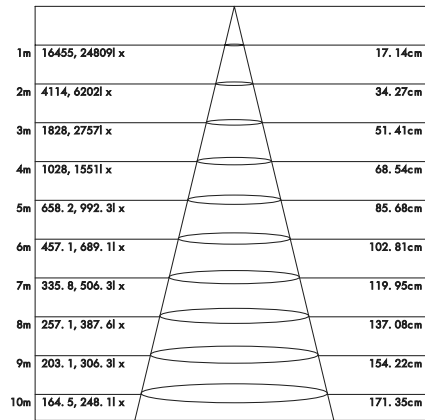

15°
(4000K)

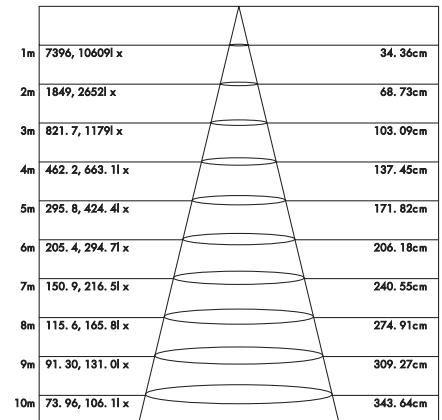

20°
(4000K)

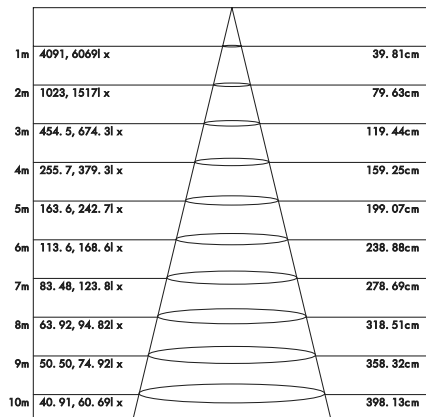

25°
(4000K)

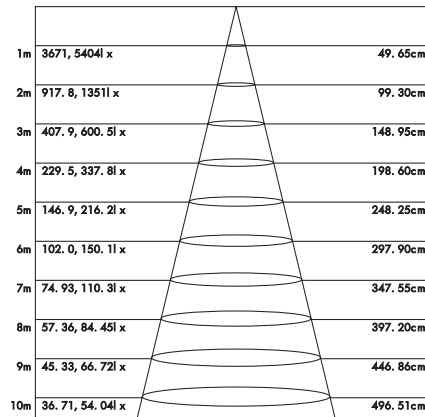

30°
(4000K)

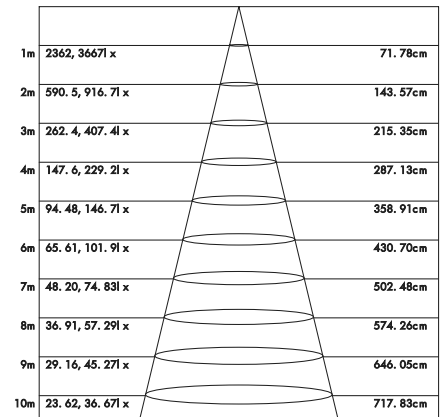

40°
(4000K)

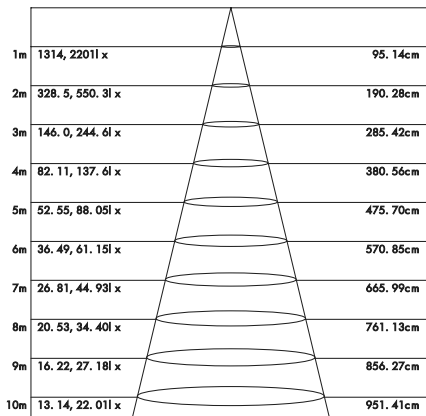

50°
(4000K)

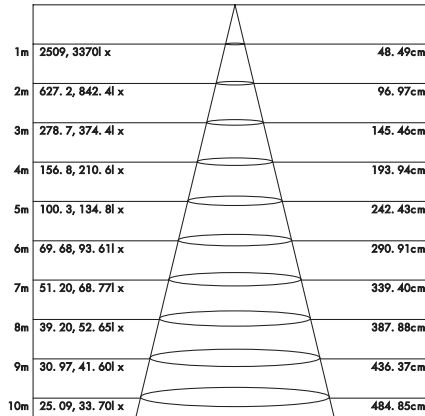

25° X 50°
(4000K)

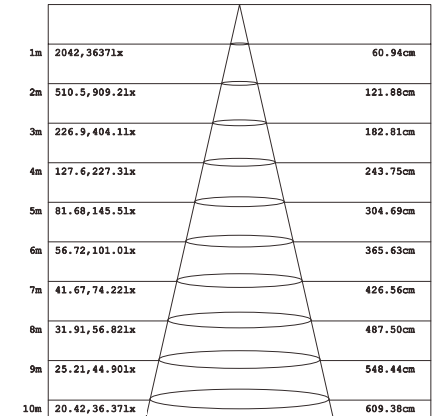

45° X 30°
(4000K)

LFO-90DB

7.6W DUAL BEND OPTIC LED STRIP

COMPATIBLE TRANSFORMERS

PSDL SERIES TRIAC DIMMABLE

PSDL-30W-24V	CLASS 2	6.5" X 3.63" X 1.03"
PSDL-60W-24V	CLASS 2	7.4" X 3.63" X 1.03"
PSDL-96W-24V	CLASS 2	8.67" X 3.67 X 1.62"
PSDL-150W-24V		8.67" X 3.67" X 1.62"
PSDL-192W-24V	CLASS 2	10.25" X 4.06" X 1.82"
PSDL-200W-24V		10.25" X 4.06" X 1.82"
PSDL-288W-24V	CLASS 2	10.25" X 4.06" X 1.82"
PSDL-300W-24V		10.25" X 4.06" X 1.82"

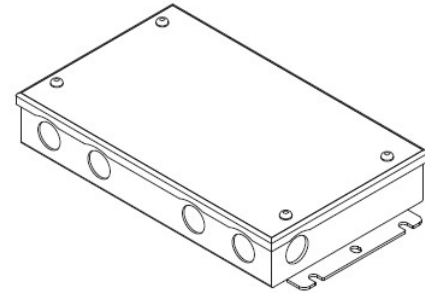

PSDH SERIES HIGH PERFORMANCE MAGNETIC LOW VOLTAGE (MLV)

PSDH-48W-24V	CLASS 2	11.25" X 3.37" X 3.25"
PSDH-96W-24V	CLASS 2	11.25" X 3.37" X 3.25"
PSDH-288W-24V	CLASS 2	14.25" X 8.43" X 4.43"

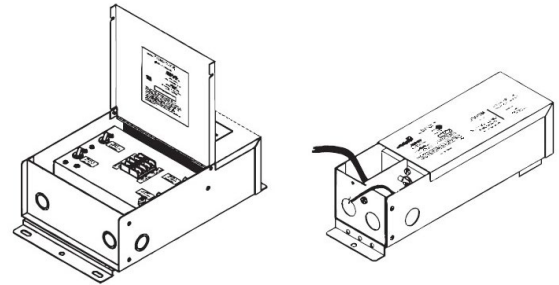

PSRX SERIES 4-IN-1 DIMMING DRIVER

PSRX-30W-24V	CLASS 2	6.5" X 3.72" X 1.57"
PSRX-60W-24V	CLASS 2	7.4" X 3.72" X 1.57"
PSRX-96W-24V	CLASS 2	8.66" X 3.72" X 1.57"
PSRX-150W-24V		10.24" X 4.13" X 1.77"
PSRX-192W-24V	CLASS 2	11" X 4" X 1.82"
PSRX-200W-24V		10.24" X 4.13" X 1.77"
PSRX-288W-24V	CLASS 2	11.85" X 4.25" X 1.82"
PSRX-300W-24V		10.94" X 4.33" X 1.77"

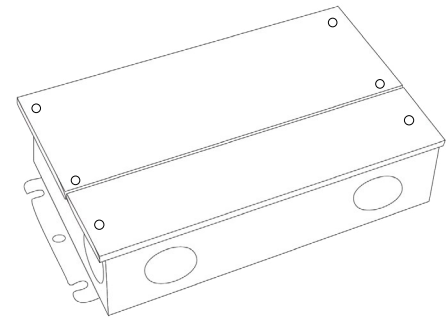

PSVT SERIES 0-10V DIMMING DRIVER

PSVT-60W-24V	CLASS 2	7.4" X 3.72" X 1.57"
PSVT-96W-24V	CLASS 2	8.66" X 3.72" X 1.57"
PSVT-200W-24V		10.24" X 4.13" X 1.77"
PSVT-288W-24V	CLASS 2	11.85" X 4.25" X 1.81"
PSVT-300W-24V		10.94" X 4.33" X 1.77"

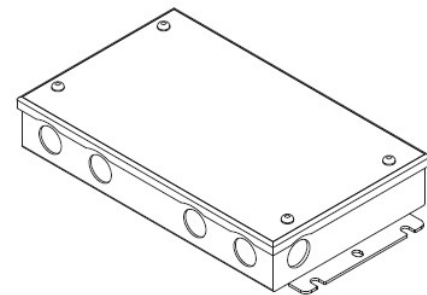

LFO-90DB

7.6W DUAL BEND OPTIC LED STRIP

COMPATIBLE TRANSFORMERS

PSDE SERIES

0-10V DIMMING W/ JUNCTION BOX

PSDE-60W-24V-010-JB	CLASS 2	12.1" X 2.36" X 1.4"
PSDE-96W-24V-010-JB	CLASS 2	12.1" X 2.36" X 1.4"

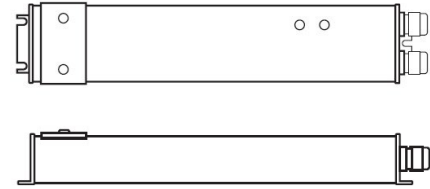

LUTRON 1%

3-WIRE DIMMING

L3DA4U1UKL-CV240	CLASS 2	4.89" X 4" X 2.62"
------------------	---------	--------------------

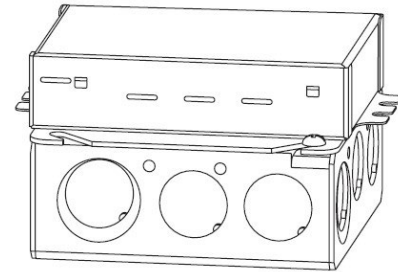

LUTRON 1%

3-WIRE DIMMING

PSDE-96W-24V-ECO	CLASS 2	10.5" X 3.0" X 2.0"
------------------	---------	---------------------

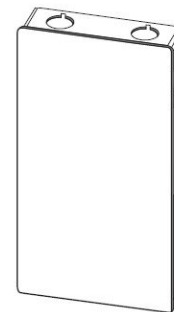

NON-DIMMING DRIVERS (COMPATABLE WITH ALL SYSTEMS)

PSHK SERIES

NON-DIMMING CONSTANT VOLTAGE WITH JUNCTION BOX

PSHK-30W-24V	CLASS 2	6.5" X 3.6" X 1.02"
PSHK-60W-24V	CLASS 2	7.4" X 3.62" X 1.02"
PSHK-96W-24V	CLASS 2	8.66" X 3.66" X 1.61"
PSHK-150W-24V		10.24" X 4.06" X 1.81"
PSHK-200W-24V		10.24" X 4.06" X 1.81"
PSHK-288W-24V	CLASS 2	11.85" X 4.25" X 1.82"
PSHK-300W-24V		10.24" X 4.25" X 1.81"

