

SLINQ RGB

RGB FLEXIBLE 360° ROUND NEON SERIES

Project _____

Location _____

Quote/ Ref # _____

Slinq RGB— IP65 rated, flexible neon rope light is a true game-changer, with its 360° illuminating capabilities and vibrant RGB color options. Unleash your creativity to create any desired shape, freeform pattern, grid, icicle chandeliers, or simply drape it along walls and ceilings. Perfect for any project, whether you're looking to create an eye-catching centerpiece or simply add some ambiance to your living space.

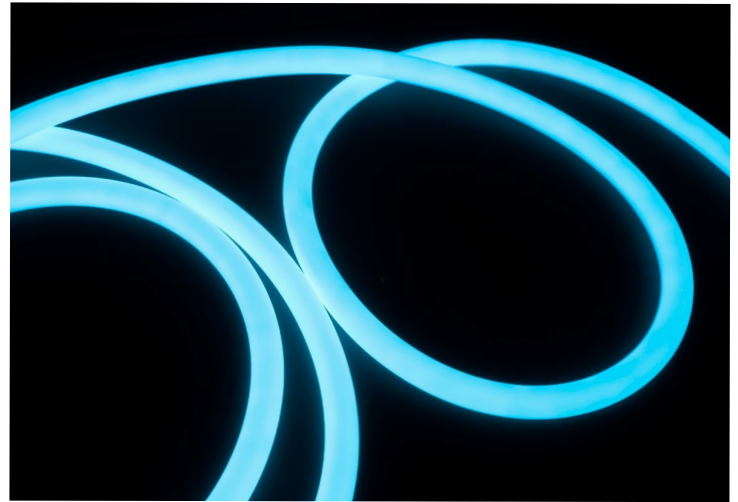

SPECIFICATIONS

POWER CONSUMPTION	4.4W per foot
LUMEN OUTPUT	317 Lm/ Ft.
CRI	90+
COLOR TEMPERATURE	RGB
MAXIMUM RUN LENGTH	16 Ft.
OPERATING VOLTAGE	24V
STORAGE TEMPERATURE	-30°C to 60°C
OPERATING TEMPERATURE	30°C (-22°F) to 55°C (131°F)
BEAM ANGLE	360°
IP RATING	IP65 Outdoor/ Wet Location
LUMEN MAINTENANCE	50,000 Hrs.

FEATURES

- 360° Light Source
- Multiple Mounting Options
- DMX Control
- IP65 Outdoor Rated
- Factory-Installed Power Feed
- Injection Moulded End-Caps
- Ideal for Decorative, Retail, Artistic Lighting

**This product is factory-cut only. Do not field modify.*



MODEL	COLOR TEMP	LENGTH	VOLTAGE	POWER FEED	MOUNTING OPTIONS
SLQ25-FX	RGB RGB	¹ PF Per Foot	24V 24 Volts	EF72 72" End Feed SF72 72" Side Feed	AR Arch SF Surface Pendant SUP Suspended Pendant SCS Suspension Cable Support SJS Suspension Joiner Support TES Telescopic Extension Support TJS Telescopic Joiner Support
		*1 = Custom length per FT. (Every 0.98")			

SLINQ RGB

RGB FLEXIBLE 360° ROUND NEON SERIES

MOUNTING OPTIONS

ARCH (AR)

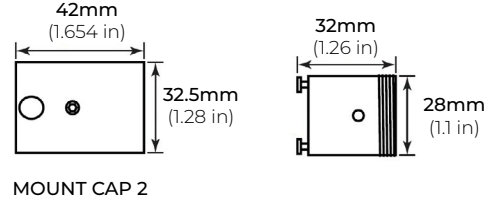
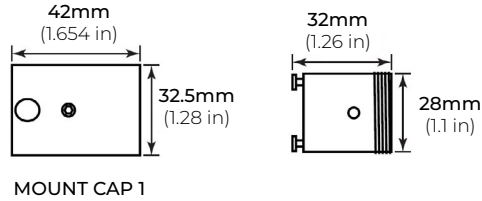
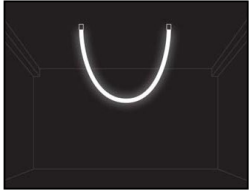

SURFACE PENDANT (SF)

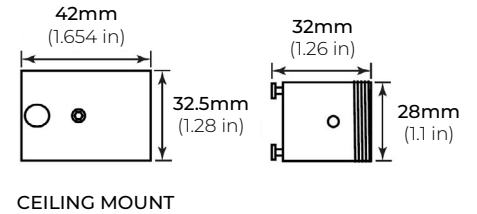
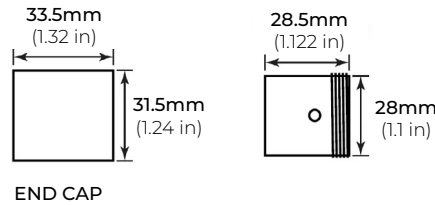
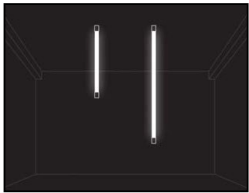

SUSPENDED PENDANT (SUP)

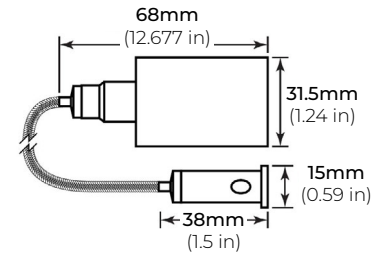
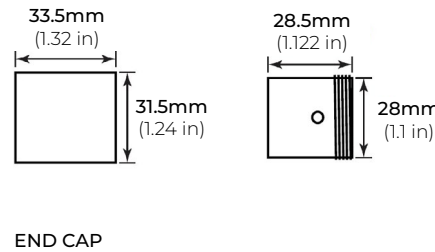
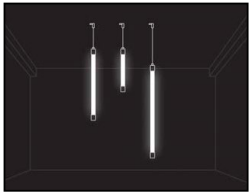

* Cable Length = 72"

SUSPENSION CABLE SUPPORT (SCS)

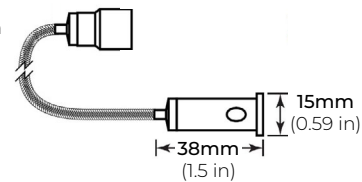
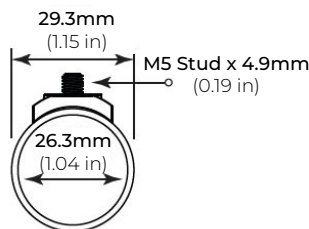
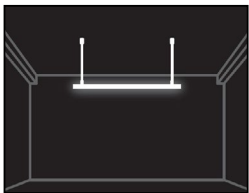

* 72" Cable included

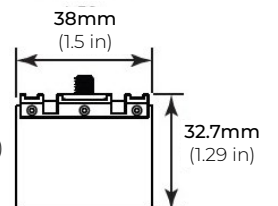

SLINQ RGB

RGB FLEXIBLE 360° ROUND NEON SERIES

MOUNTING OPTIONS

SUSPENSION JOINER SUPPORT (SJS)

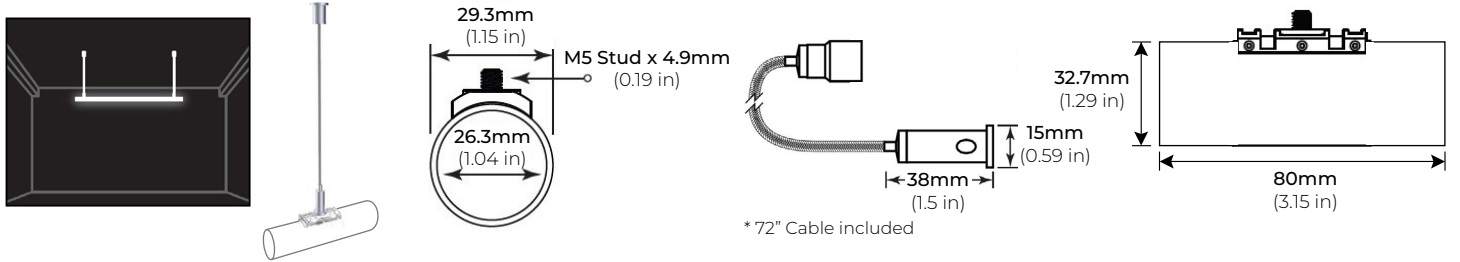

TELESCOPIC EXTENSION SUPPORT (TES)

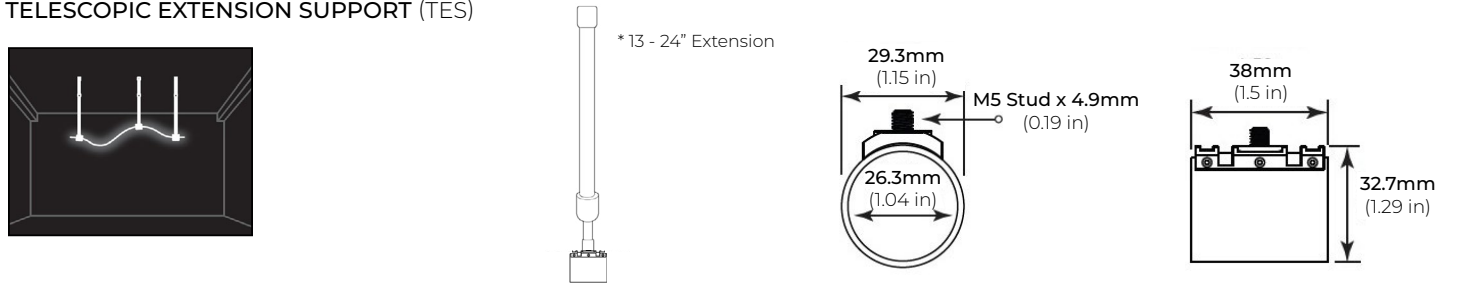

TELESCOPIC JOINER SUPPORT (TJS)

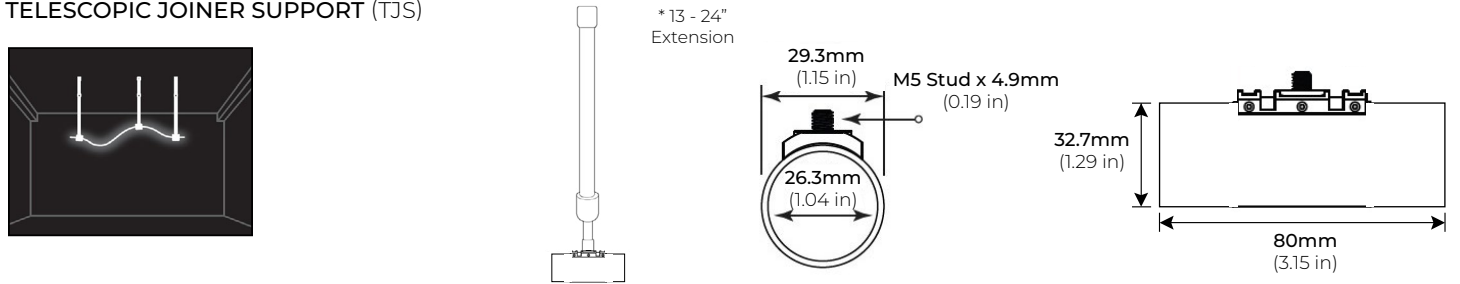

SLINQ RGB

RGB FLEXIBLE 360° ROUND NEON SERIES

ACCESSORIES

SLQ25-RSM-WH
WHITE RECESSED MOUNT KIT
Ø64MM x 20mm (D x H)

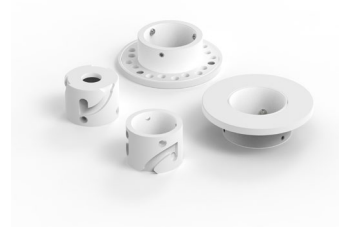

SLQ25-TSM-WH
WHITE TRIMLESS MOUNT KIT
Ø62MM x 20mm (D x H)

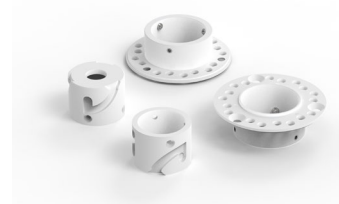

SLQ25-VMC
VISIBLE MOUNTING CLIP

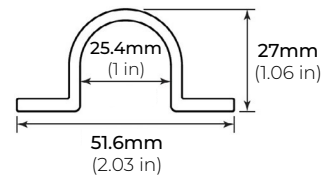

SLQ25-DMB
DISCREET MOUNTING BRACKET

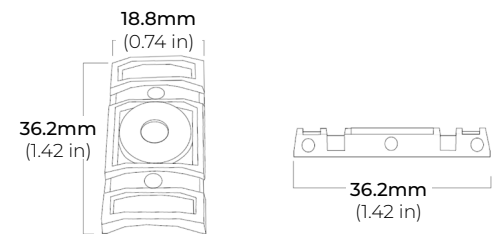

SLQ25-IJ
INFINITY JOINER

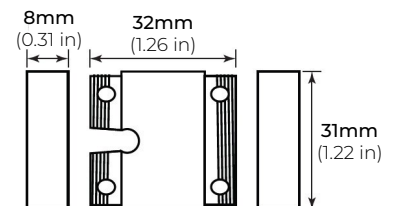
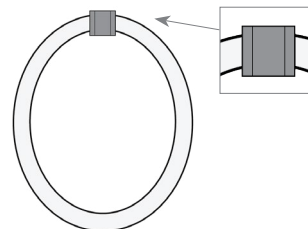

SLINQ RGB

RGB FLEXIBLE 360° ROUND NEON SERIES

ACCESSORIES

SLQ25-RTS-39-S
39" RIGID TUBE

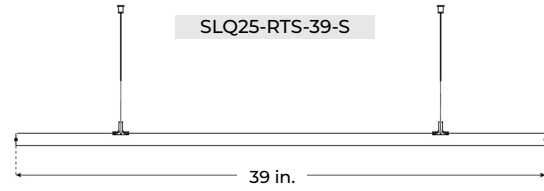

SLQ25-RTS-78-S
78" RIGID TUBE

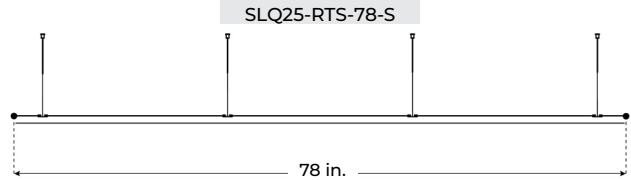

ROUND PLATE SUSPENSION KIT

SLQ25-RPS-BK SMALL ROUND PLATE (BLACK)
SLQ25-RPM-BK MEDIUM ROUND PLATE (BLACK)
SLQ25-RPL-BK LARGE ROUND PLATE (BLACK)

SLQ25-RPS-WH SMALL ROUND PLATE (WHITE)
SLQ25-RPM-WH MEDIUM ROUND PLATE (WHITE)
SLQ25-RPL-WH LARGE ROUND PLATE (WHITE)

*SCREWS INCLUDED

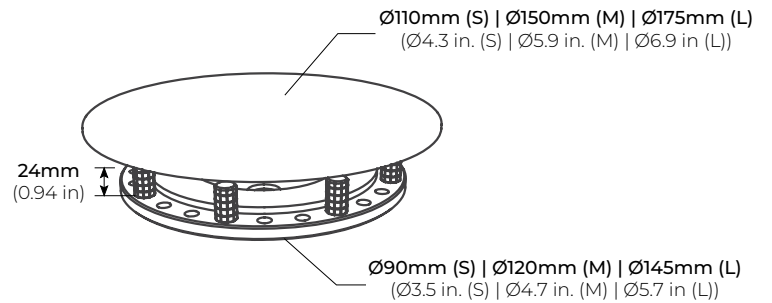

DIMENSIONS

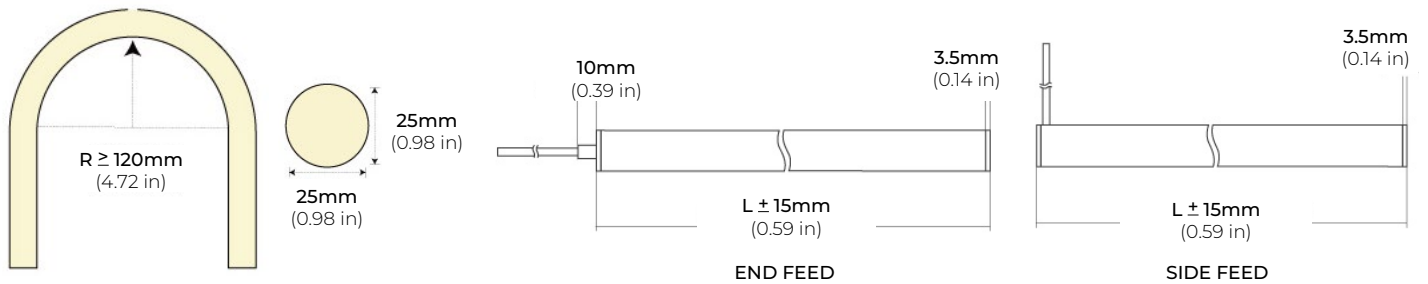

SLINQ RGB

RGB FLEXIBLE 360° ROUND NEON SERIES

DMX CONTROLLERS

All DMX Controllers require a DMX Decoder and Non-Dimming Driver.
Please refer for page 7 and 10 for compatible options.

RGB CT600 MULTI-FUNCTION RGBW WALL CONTROLLER

INPUT VOLTAGE	5V DC, 1A
OUTPUT SIGNAL	RF 2.4GHZ + DMX512
CONTROL	4 ZONES
COLOR OPTIONS	Black/ White
WORKING TEMP	-20°C ~ 40°C
DIMENSIONS	LxWxH (5.19"x7.08"x1.38")

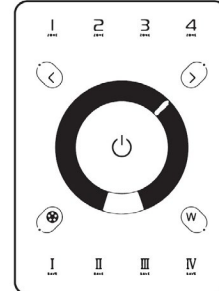

RGB-SCW4 WiFi DMX WALL CONTROLLER

INPUT VOLTAGE	5 - 10V DC, 06A
OUTPUT SIGNAL	DMX512 (x2)
PROGRAMMABILITY	PC/ MAC
COLOR OPTIONS	Black/ White
CONNECTIONS	USB/ 8dry contact ports/ Open drain output (for relay)
MEMORY	Built-In Flash
WORKING TEMP	-10°C ~ 45°C
DIMENSIONS	LxWxH (5.75"x4.17"x0.43")

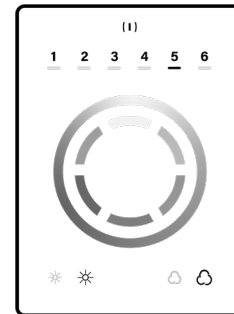

RGB-SDE3 WiFi DMX WALL CONTROLLER

INPUT VOLTAGE	6V DC, 0.6A
OUTPUT SIGNAL	DMX512 (x2)
PROGRAMMABILITY	PC/ MAC/ Tablet/ Smartphone
COLOR OPTIONS	Black/ White
CONNECTIONS	USB/ Ethernet/ RS232/ CLock/ 8dry contact ports/ 5V output relay
MEMORY	MicroSD Card
WORKING TEMP	-20°C ~ 40°C
DIMENSIONS	LxWxH (5.75"x4.17"x0.43")

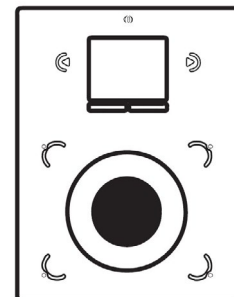

SLINQ RGB

RGB FLEXIBLE 360° ROUND NEON SERIES

DMX DECODERS

All DMX Decoders require a DMX Controller and Non-Dimming Driver.
Please refer for page 6 and 10 for compatible options.

RGB-DMX-4C-RJ45 4-CHANNEL DMX DECODER

INPUT VOLTAGE 12V-24V DC
OUTPUT CURRENT 8A X 4CH
OUTPUT WATTAGE 60W(12V), 120W(24V)
OUTPUT CHANNELS 4
DIMENSIONS LxWxH (6.5"x2.38"x1.27")

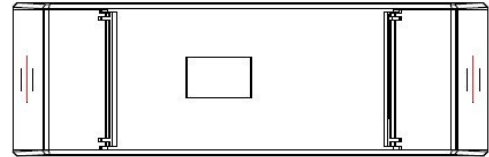

RGB-DMX-5C-XLR 5-CHANNEL DMX DECODER

INPUT VOLTAGE 12V-24V DC
OUTPUT CURRENT 8A X 5CH
OUTPUT WATTAGE 5 x (96W ~ 192W)
OUTPUT CHANNELS 5
DIMENSIONS LxWxH (6.45"x2.87"x1.5")

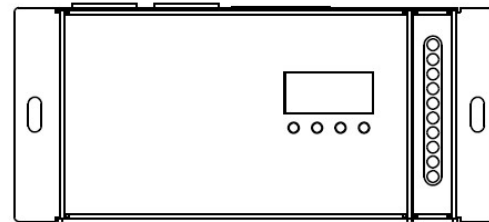

SLINQ RGB

RGB FLEXIBLE 360° ROUND NEON SERIES

NON-DMX CONTROLLERS

RGB-CT550

RGBW WIRELESS RECEIVER / CONTROLLER SYSTEM

INPUT VOLTAGE	DC5V ~ DC24V
POWER CAPACITY	100W (5V) 240W (12V) 480W (24V)
OUTPUT CURRENT	5A per Channel (20A Total)
WORKING TEMP	-30°C~55°C (-22°F~131°F)
DIMENSIONS	LxWxH (6.89"x1.73"x1.18")

* Paired with RGB-CT550-RX (Sold Separately)

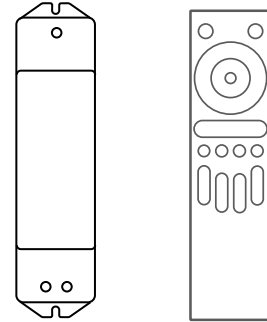

* RGB-CT550-RX
(Sold Separately)

RGB-CT550-RX

RGBW WIRELESS RECEIVER / CONTROLLER SYSTEM (REMOTE)

REMOTE DISTANCE	100 Ft. (Line of Sight)
FREQUENCY	2.4 GHz
DIMENSIONS	LxWxH (6.38"x1.65"x0.59")
WEIGHT	0.44lbs.

* Paired with RGB-CT550 (Sold Separately)

RGB-CT700

MASTER RGBW WIFI CONTROLLER

INPUT VOLTAGE	12-24V DC
OUTPUT TYPE	Constant Voltage
POWER CAPACITY	288W (12V) 384W (24V)
OUTPUT CURRENT	5A per Channel (20A Total)
WORKING TEMP	-4°F (-20°C) ~ 122°F (50°C)
DIMENSIONS	LxWxH (7 x1.8 x 0.8")

* Paired with RGB-CT705ZR (Sold Separately)

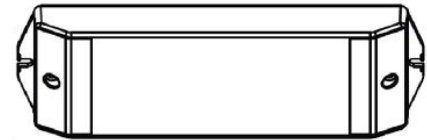

RGB-CT705ZR

SLAVE RGBW WIFI CONTROLLER

INPUT VOLTAGE	12-24V DC
OUTPUT TYPE	Constant Voltage
POWER CAPACITY	288W (12V) 384W (24V)
OUTPUT CURRENT	5A per Channel (20A Total)
WORKING TEMP	-4°F (-20°C) ~ 122°F (50°C)
DIMENSIONS	LxWxH (7 x0,63 x 0.71")

* Paired with RGB-CT700 (Sold Separately)

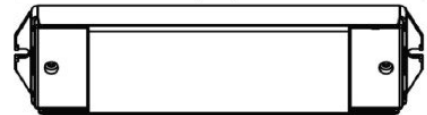

SLINQ RGB

RGB FLEXIBLE 360° ROUND NEON SERIES

NON-DMX CONTROLLERS (CONTINUED)

RGB-CT840 BLUETOOTH TOUCH PANEL WALL CONTROLLER

INPUT VOLTAGE	12-24V DC
ZONES	4
CONTROL MODE	RGB RGBW
WIRELESS PROTOCOL	Bluetooth 5.0 SIG Mesh
WORKING TEMP	-20°C ~ 55°C
DIMENSIONS	LxWxH (4.7"x3"x1.2")

** Paired with RGB-CT800-RC (Sold Separately)*



RGB-CT800-RC BLUETOOTH CONSTANT VOLTAGE LED RECEIVER

INPUT VOLTAGE	12V 24V
OUTPUT CURRENT	4Ax5CH / 5Ax4CH (20A Max)
POWER CAPACITY	240W (12V) 480W (24V)
PROGRAMMABILITY	iOS and Android
WORKING TEMP	-20°C ~ 55°C
DIMENSIONS	LxWxH (6.9 x1.7 x 1.2")

** Paired with RGB-CT840 (Sold Separately)*



SLINQ RGB

RGB FLEXIBLE 360° ROUND NEON SERIES

NON-DIMMING DRIVERS

PSHK SERIES

NON-DIMMING CONSTANT VOLTAGE WITH JUNCTION BOX

PSHK-30W-24V	CLASS 2	6.5" X 3.6" X 1.02"
PSHK-60W-24V	CLASS 2	7.4" X 3.62" X 1.02"
PSHK-96W-24V	CLASS 2	8.66" X 3.66" X 1.61"
PSHK-150W-24V		10.24" X 4.06" X 1.81"
PSHK-200W-24V		10.24" X 4.06" X 1.81"
PSHK-288W-24V	CLASS 2	11.85" X 4.25" X 1.82"
PSHK-300W-24V		10.24" X 4.25" X 1.81"

