

# LRB-1300

## HIGH POWER 90CRI RIGID LED STRIP

Project \_\_\_\_\_

Location \_\_\_\_\_

Quote/ Ref # \_\_\_\_\_

**LRB-1300** is an high-powered lighting solution to a wide variety of lighting needs and applications. This indoor rated rigid LED strip delivers 8.64 W/Ft. and 150 Lm/W. It is available in 12" and 48" and in 4 CCT options: 27K, 30K, 35K and 40K. Comes with a 3M adhesive backing for an easy install ( just peel-off and attach to installation surface). CA Title 24 JA8 compliant.



### SPECIFICATIONS

INPUT VOLTAGE	24V DC
POWER CONSUMPTION	8.64W/Pc. (12")   34.56W/Pc. (48")
NO. OF LEDS	48 LEDS per Ft. (12") 192 LEDS per Ft. (48")
LUMEN OUTPUT	1100Lm/Ft., 130Lm/W (12")
CRI	95+
COLOR TEMPERATURE	27K/ 30K/ 35K/ 40K
DIMMING	MLV, ELV, 0-10V and TRIAC
MAXIMUM RUN LENGTH	6 pcs. (12")   2 pcs. (48")
CUTTABLE	No
OPERATING TEMPERATURE	-40°F (-40°C) to 140°F (+60°C)
BEAM ANGLE	120°
IP RATING	IP45 dry location (indoor)
CERTIFICATIONS	UL Listed, California TITLE JA8
LUMEN MAINTENANCE	50,000 Hrs.



MODEL	LED LENGTH	COLOR TEMP	VOLTAGE	PROFILE
LRB	1312 12" (8.64W)	27K 2700K	24V 24V DC	See Page 2 for compatible profiles.
	1348 48" (34.56W)	30K 3000K		
		35K 3500K		
		40K 4000K		

\* Custom color finishes require powder coating. Allow 7 days leads time.

# LRB-1300

## HIGH POWER 90CRI RIGID LED STRIP

### DIMENSIONS

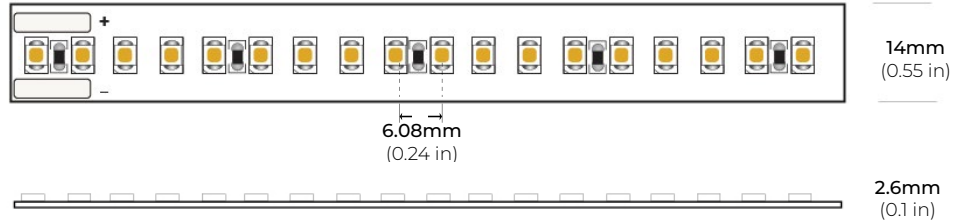

### COMPATIBLE ALUMINUM PROFILES

#### SURFACE PROFILES

##### ALU-DS100

LENGTHS 39" | 78" | 84"  
LENS Clear, Frosted  
FINISH Silver

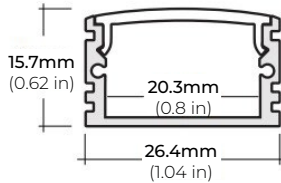

##### ALP-90

LENGTHS 48" | 96"  
LENS Frosted  
FINISH Silver

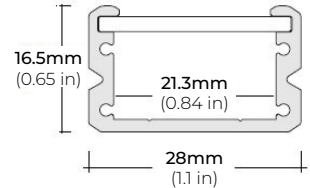

##### ALP-100C

LENGTHS 49" | 98"  
LENS Frosted  
FINISH Silver

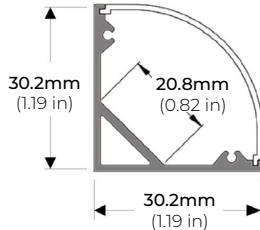

##### ALP-130

LENGTHS 49" | 84" | 98"  
LENS Frosted  
FINISH Silver

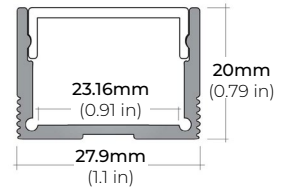

##### ALP-140

LENGTHS 48" | 98"  
LENS Frosted  
FINISH Silver

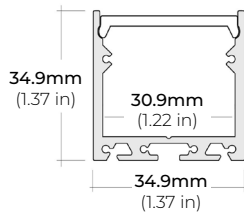

##### ALP-190

LENGTHS 48" | 98"  
LENS Frosted  
FINISH Silver

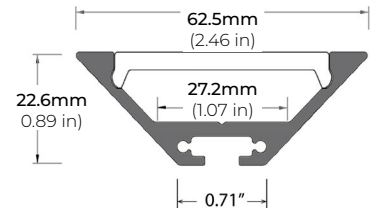

\* For more compatible profiles, visit [corelightingusa.com](http://corelightingusa.com)

#### RECESED PROFILES

##### ALP-102R

LENGTHS 49" | 98"  
LENS Frosted, Black, Asymmetric, Double Asymmetric  
FINISH White | Black | Silver

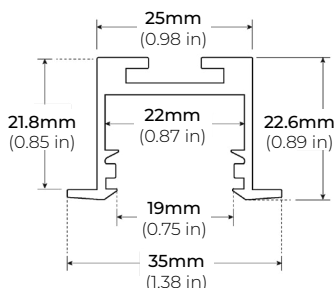

##### ALP-230RN

LENGTHS 49" | 98"  
LENS Frosted  
FINISH Silver

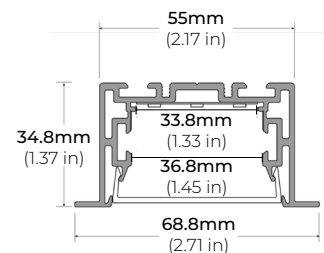

\* For more compatible profiles, visit [corelightingusa.com](http://corelightingusa.com)

# LRB-1300

## HIGH POWER 90CRI RIGID LED STRIP

### COMPATIBLE TRANSFORMERS

#### PSDL SERIES TRIAC DIMMABLE

PSDL-30W-24V	CLASS 2	6.5" X 3.63" X 1.03"
PSDL-60W-24V	CLASS 2	7.4" X 3.63" X 1.03"
PSDL-96W-24V	CLASS 2	8.67" X 3.67" X 1.62"
PSDL-150W-24V		8.67" X 3.67" X 1.62"
PSDL-192W-24V	CLASS 2	10.25" X 4.06" X 1.82"
PSDL-200W-24V		10.25" X 4.06" X 1.82"
PSDL-288W-24V	CLASS 2	10.25" X 4.06" X 1.82"
PSDL-300W-24V		10.25" X 4.06" X 1.82"

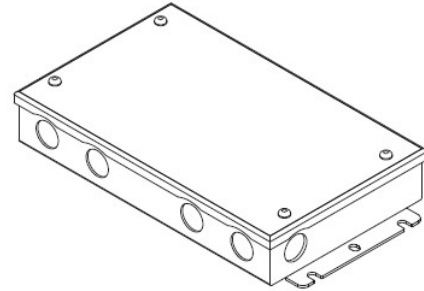

#### PSDH SERIES HIGH PERFORMANCE MAGNETIC LOW VOLTAGE (MLV)

PSDH-48W-24V	CLASS 2	11.25" X 3.37" X 3.25"
PSDH-96W-24V	CLASS 2	11.25" X 3.37" X 3.25"
PSDH-288W-24V	CLASS 2	14.25" X 8.43" X 4.43"

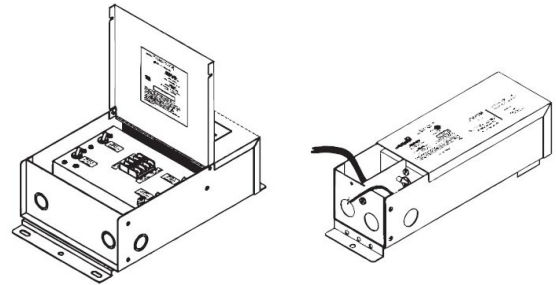

#### PSRX SERIES 4-IN-1 DIMMING DRIVER

PSRX-30W-24V	CLASS 2	6.5" X 3.72" X 1.57"
PSRX-60W-24V	CLASS 2	7.4" X 3.72" X 1.57"
PSRX-96W-24V	CLASS 2	8.66" X 3.72" X 1.57"
PSRX-150W-24V		10.24" X 4.13" X 1.77"
PSRX-192W-24V	CLASS 2	11" X 4" X 1.82"
PSRX-200W-24V		10.24" X 4.13" X 1.77"
PSRX-288W-24V	CLASS 2	11.85" X 4.25" X 1.82"
PSRX-300W-24V		10.94" X 4.33" X 1.77"

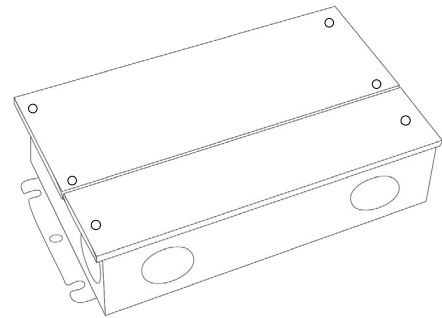

#### PSVT SERIES 0-10V DIMMING DRIVER

PSVT-60W-24V	CLASS 2	7.4" X 3.72" X 1.57"
PSVT-96W-24V	CLASS 2	8.66" X 3.72" X 1.57"
PSVT-200W-24V		10.24" X 4.13" X 1.77"
PSVT-288W-24V	CLASS 2	11.85" X 4.25" X 1.81"
PSVT-300W-24V		10.94" X 4.33" X 1.77"

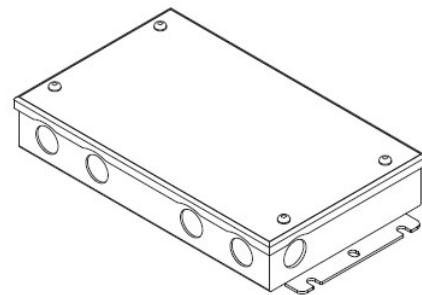

# LRB-1300

## HIGH POWER 90CRI RIGID LED STRIP

### COMPATIBLE TRANSFORMERS

#### PSDE SERIES

0-10V DIMMING W/ JUNCTION BOX

PSDE-60W-24V-010-JB	CLASS 2	12.1" X 2.36" X 1.4"
PSDE-96W-24V-010-JB	CLASS 2	12.1" X 2.36" X 1.4"

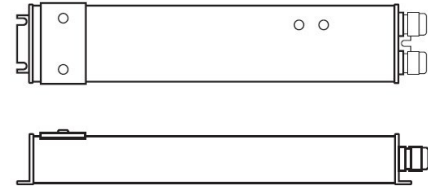

#### LUTRON 1%

3-WIRE DIMMING

L3DA4U1UKL-CV240	CLASS 2	4.0" X 1.5" X 4.0"
------------------	---------	--------------------

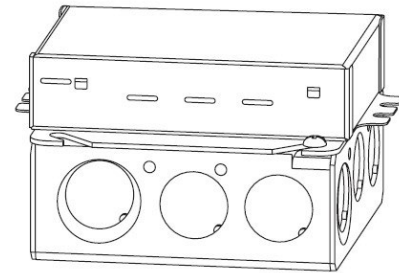

#### LUTRON 1%

3-WIRE DIMMING

PSDE-96W-24V-ECO	CLASS 2	10.5" X 3.0" X 2.0"
------------------	---------	---------------------

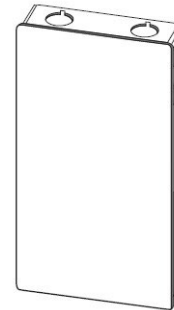

### COMPATIBLE NON-DIMMING DRIVERS

#### PSHK SERIES

NON-DIMMING CONSTANT VOLTAGE WITH JUNCTION BOX

PSHK-30W-24V	CLASS 2	6.5" X 3.6" X 1.02"
PSHK-60W-24V	CLASS 2	7.4" X 3.62" X 1.02"
PSHK-96W-24V	CLASS 2	8.66" X 3.66" X 1.61"
PSHK-150W-24V		10.24" X 4.06" X 1.81"
PSHK-200W-24V		10.24" X 4.06" X 1.81"
PSHK-288W-24V	CLASS 2	11.85" X 4.25" X 1.82"
PSHK-300W-24V		10.24" X 4.25" X 1.81"

