

LNT-45

4.4W IP67/68 FLEXIBLE LED NEON SERIES

Project _____

Location _____

Quote/ Ref # _____

LNT45 is a high performance flexible LED fixture designed as a neon replacement. Suitable for indoor and outdoor applications, the LNT45 easily bends around contours and tight curves without being damaged. It allows for easy installation with its factory sealed terminators and self-locking male and female barrel connectors.

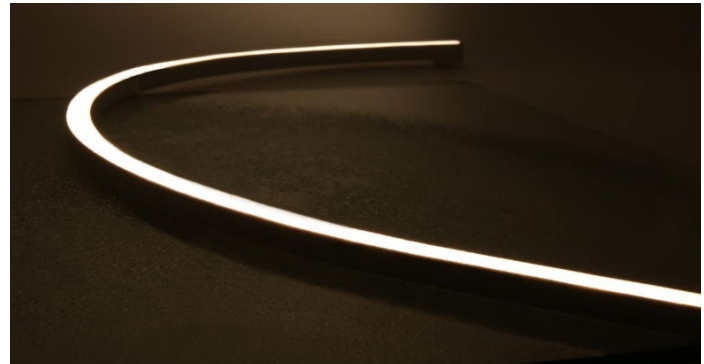

SPECIFICATIONS

INPUT VOLTAGE	24V DC Constant Voltage
POWER CONSUMPTION	4.4W per Ft.
LUMEN OUTPUT	140 Lm/ Ft. (Flat) 115 Lm/ Ft. (Dome)
CRI	88+
COLOR TEMPERATURE	22K / 27K / 30K / 35K / 40K / 50K RD / GN / BL / AM / PK / YW
DIMMING/ CONTROL	MLV, ELV, 0-10 and TRIAC
MAXIMUM RUN LENGTH	32 Ft.
CUT POINT	Every 83.3mm (3.28 in)
POWER FACTOR	≤1
STORAGE TEMPERATURE	-40°F (-40°C) to 140°F (60°C)
OPERATING TEMPERATURE	-40°F (-40°C) to 131°F (55°C)
BEAM ANGLE	160° (Flat) 270° (Dome)
HUMIDITY	0-95% Non Condensing
IP RATING	IP67/ 68
CERTIFICATIONS	UL Listed
LUMEN MAINTENANCE	50,000 Hrs.

FEATURES

- High color consistency
- Smooth illumination
- Continuous run length up to 32 Ft.
- Waterproof, submersible under water
- Bottom, Side and End Feed options
- UL Listed (US and Canada)

**This product is factory-cut only. Do not field modify.*



MODEL	LENS	COLOR TEMP	LENGTH (PF)	VOLTAGE	POWER FEED	FEED LENGTH	
LNT-45	F Flat	22K 2700K	RD Red	Please refer to page 5 for exact lengths with corresponding ordering codes.	24 24V DC	BF Bottom Feed	HW3 3 Ft. Power Feed
	D Dome	27K 2700K	GN Green			SFL Side Feed Left	HW10 10 Ft. Power Feed
		30K 3000K	BL Blue			SFR Side Feed Right	HW16 16 Ft. Power Feed
		35K 3500K	AM Amber			EF End Feed	HW32 32 Ft. Power Feed
		40K 4000K	PK Pink				HW50 50 Ft. Power Feed
		50K 5000K	YW Yellow				
		60K 6000K					

LNT-45

4.4W IP67/68 FLEXIBLE LED NEON SERIES

DIMENSIONS

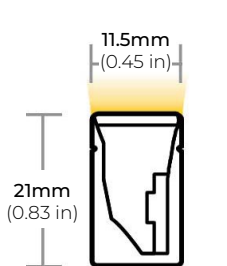
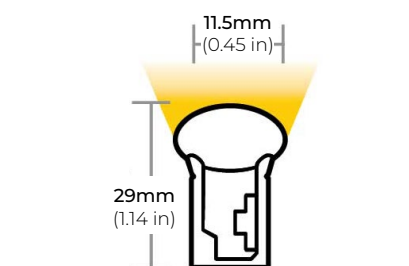
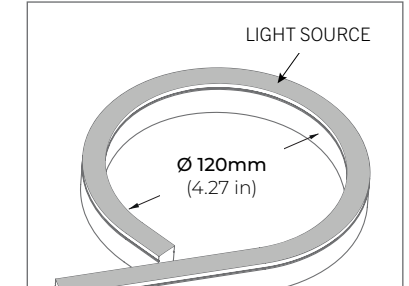
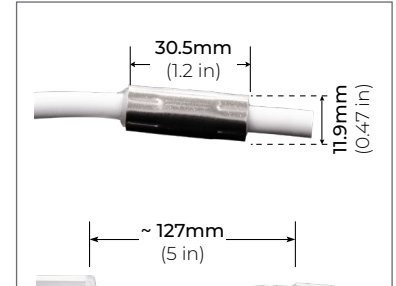
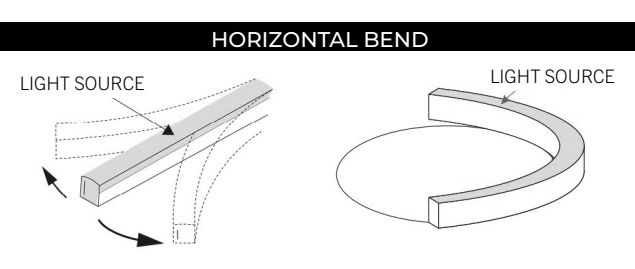
 <p>11.5mm (0.45 in)</p> <p>21mm (0.83 in)</p> <p>FLAT LENS</p>	 <p>11.5mm (0.45 in)</p> <p>29mm (1.14 in)</p> <p>DOME LENS</p>	 <p>LIGHT SOURCE</p> <p>Ø 120mm (4.27 in)</p>	 <p>30.5mm (1.2 in)</p> <p>11.9mm (0.47 in)</p> <p>~ 127mm (5 in)</p>
<p>HORIZONTAL BEND</p>		<p>BEND DIAMETER</p>	<p>POWER FEED CHOKER</p>
 <p>LIGHT SOURCE</p> <p>LIGHT SOURCE</p>		<p>LED strip only bends along horizontal axis. Bending the LED strip vertically (perpendicular) to the light surface risks damage to the LED strip. Do NOT bend more than the indicated bend radius (shown above). Doing so will damage the LED strip.</p>	<p>All CORE Lighting IP67/IP68 Neons include a choker that sits roughly 5" from the end of the Neon.</p> <p><i>*Warranty is void if removed.</i></p>

COMPATIBLE ACCESSORIES

SELF LOCKING ALUMINUM PROFILE

LNT45-AC2
1.38" PROFILE

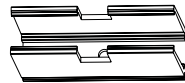

LNT45-AC2



LNT45-AC39

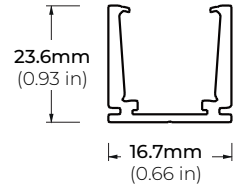

PLASTIC PROFILE

LNT45-PC39
39" PROFILE

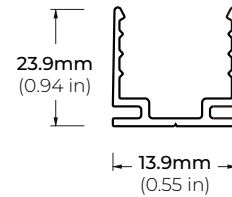
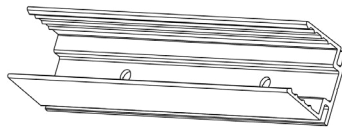

FLEXIBLE ALUMINUM CHANNEL

LNT45-AFX
39" CHANNEL

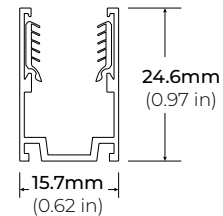
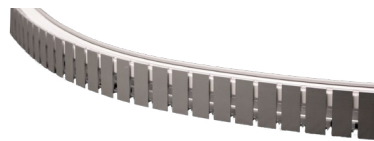

LNT-45

4.4W IP67/68 FLEXIBLE LED NEON SERIES

COMPATIBLE ACCESSORIES

LNT45-BKT-ADJ
ADJUSTABLE BRACKET

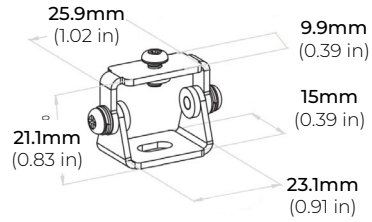

RACEWAY PROFILE

LNT45-SMR-AC39-SI
39" PROFILE (SILVER)

LNT45-SMR-AC39-WH
39" PROFILE (WHITE)

*Made to Order.

LNT45-SMR-AC39-BK
39" PROFILE (BLACK)

*Made to Order.

LNT45-SMR-EC
END CAPS

* Set of 2 (1 with Hole and 1 without Hole)

* Sold Separately

LNT45-SMR-SC
JOINER BRACKET

* Sold Separately

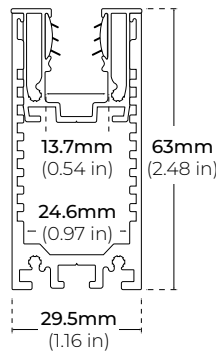

LNT45-SMR-AC39

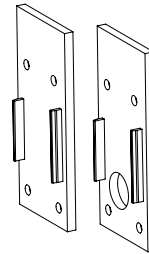

LNT45-SMR-EC

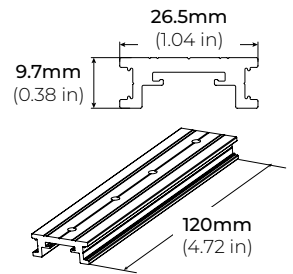

LNT45-SMR-JB

LNT-45

4.4W IP67/68 FLEXIBLE LED NEON SERIES

IP67/68 POWER FEED

FLAT

DOME

EF
END FEED

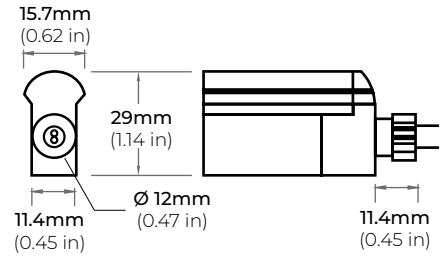
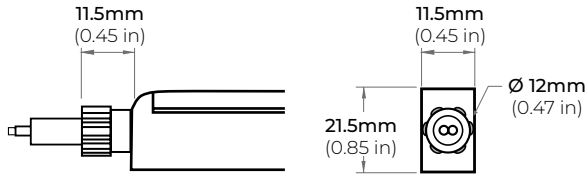

SFL
SIDE FEED LEFT

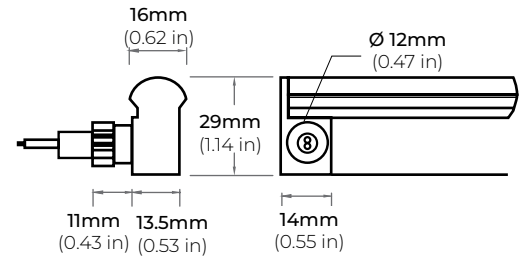
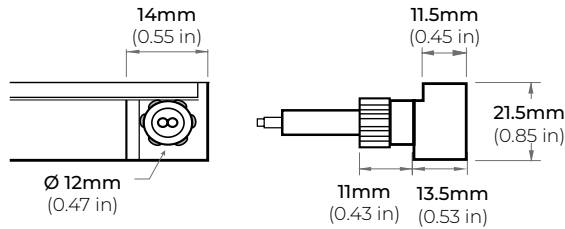

SFR
SIDE FEED RIGHT

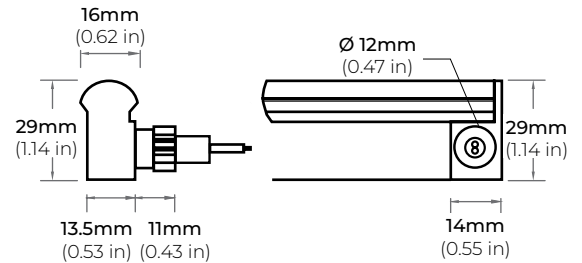
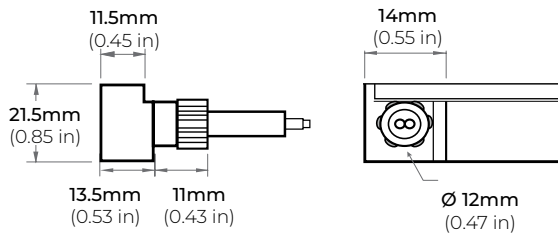

BF
BOTTOM FEED

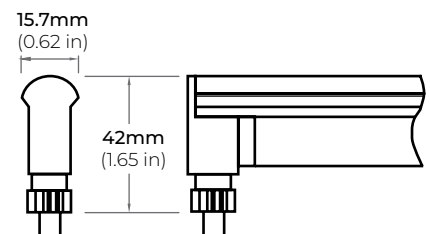
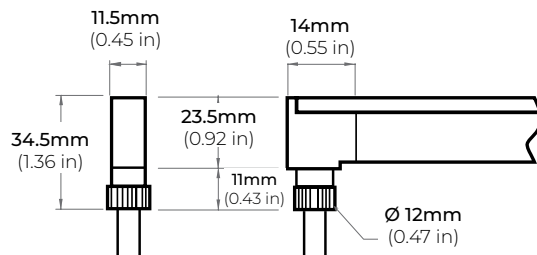

EC
END CAP

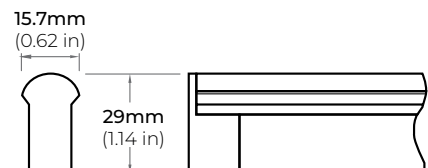
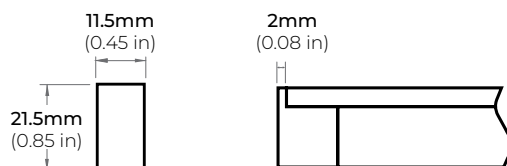

LNT-45

4.4W IP67/68 FLEXIBLE LED NEON SERIES

CUTTING LENGTH CODES

LNT-45 Series is cuttable every **3.28" (8.33CM)**. Please refer to the chart below to determine actual lengths once LED is cut versus actual lengths required or specified.

Total Length Calculation = Order Code Length + End Feed option Length
Example: 50.3" Total Length = Order Code 15 (49.2") + (1.1") End Feed

POWER FEED OPTION	
END FEED	1.1"
BOTTOM FEED	0.20"
SIDE FEED	0.20"

CUTTING LENGTH INCREMENT TABLE

CODE	LENGTH (CM)	LENGTH (IN)
1	8.33	3.28
2	16.66	6.56
3	24.99	9.84
4	33.32	13.12
5	41.65	16.4
6	49.98	19.68
7	58.31	22.96
8	66.64	26.24
9	74.97	29.52
10	83.3	32.8
11	91.63	36.08
12	99.96	39.36
13	108.29	42.64
14	116.62	45.92
15	124.95	49.2
16	133.28	52.48
17	141.61	55.76
18	149.94	59.04
19	158.27	62.32
20	166.6	65.6
21	174.93	68.88
22	183.26	72.16
23	191.59	75.44
24	199.92	78.72
25	208.25	82
26	216.58	85.28
27	224.91	88.56
28	233.24	91.84
29	241.57	95.12
30	249.9	98.4
31	258.23	101.68
32	266.56	104.96
33	274.89	108.24
34	283.22	111.52
35	291.55	114.8
36	299.88	118.08
37	308.21	121.36
38	316.54	124.64
39	324.87	127.92
40	333.2	131.2

CODE	LENGTH (CM)	LENGTH (IN)
41	341.53	134.48
42	349.86	137.76
43	358.19	141.04
44	366.52	144.32
45	374.85	147.6
46	383.18	150.88
47	391.51	154.16
48	399.84	157.44
49	408.17	160.72
50	416.5	164
51	424.83	167.28
52	433.16	170.56
53	441.49	173.84
54	449.82	177.12
55	458.15	180.4
56	466.48	183.68
57	474.81	186.96
58	483.14	190.24
59	491.47	193.52
60	499.8	196.8
61	508.13	200.08
62	516.46	203.36
63	524.79	206.64
64	533.12	209.92
65	541.45	213.2
66	549.78	216.48
67	558.11	219.76
68	566.44	223.04
69	574.77	226.32
70	583.1	229.6
71	591.43	232.88
72	599.76	236.16
73	608.09	239.44
74	616.42	242.72
75	624.75	246
76	633.08	249.28
77	641.41	252.56
78	649.74	255.84
79	658.07	259.12
80	666.4	262.4

CODE	LENGTH (CM)	LENGTH (IN)
81	674.73	265.68
82	683.06	268.96
83	691.39	272.24
84	699.72	275.52
85	708.05	278.8
86	716.38	282.08
87	724.71	285.36
88	733.04	288.64
89	741.37	291.92
90	749.7	295.2
91	758.03	298.48
92	766.36	301.76
93	774.69	305.04
94	783.02	308.32
95	791.35	311.6
96	799.68	314.88
97	808.01	318.16
98	816.34	321.44
99	824.67	324.72
100	833	328
101	841.33	331.28
102	849.66	334.56
103	857.99	337.84
104	866.32	341.12
105	874.65	344.4
106	882.98	347.68
107	891.31	350.96
108	899.64	354.24
109	907.97	357.52
110	916.3	360.8
111	924.63	364.08
112	932.96	367.36
113	941.29	370.64
114	949.62	373.92
115	957.95	377.2
116	966.28	380.48
117	974.61	383.76

LNT-45

4.4W IP67/68 FLEXIBLE LED NEON SERIES

COMPATIBLE TRANSFORMERS

PSDL SERIES TRIAC DIMMABLE

PSDL-30W-24V	CLASS 2	6.5" X 3.63" X 1.03"
PSDL-60W-24V	CLASS 2	7.4" X 3.63" X 1.03"
PSDL-96W-24V	CLASS 2	8.67" X 3.67 X 1.62"
PSDL-150W-24V		8.67" X 3.67" X 1.62"
PSDL-192W-24V	CLASS 2	10.25" X 4.06" X 1.82"
PSDL-200W-24V		10.25" X 4.06" X 1.82"
PSDL-288W-24V	CLASS 2	10.25" X 4.06" X 1.82"
PSDL-300W-24V		10.25" X 4.06" X 1.82"

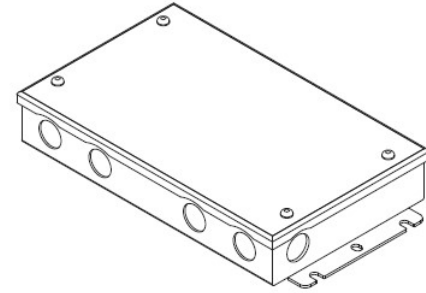

PSDH SERIES HIGH PERFORMANCE MAGNETIC LOW VOLTAGE (MLV)

PSDH-48W-24V	CLASS 2	11.25" X 3.37" X 3.25"
PSDH-96W-24V	CLASS 2	11.25" X 3.37" X 3.25"
PSDH-288W-24V	CLASS 2	14.25" X 8.43" X 4.43"

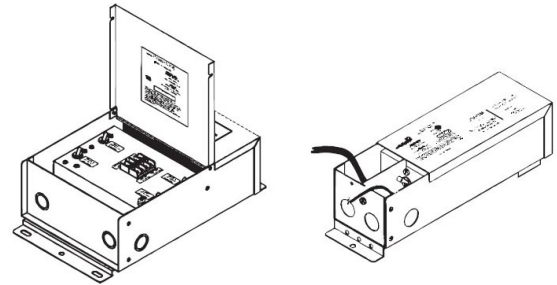

PSRX SERIES 4-IN-1 DIMMING DRIVER

PSRX-30W-24V	CLASS 2	6.5" X 3.72" X 1.57"
PSRX-60W-24V	CLASS 2	7.4" X 3.72" X 1.57"
PSRX-96W-24V	CLASS 2	8.66" X 3.72" X 1.57"
PSRX-150W-24V		10.24" X 4.13" X 1.77"
PSRX-192W-24V	CLASS 2	11" X 4" X 1.82"
PSRX-200W-24V		10.24" X 4.13" X 1.77"
PSRX-288W-24V	CLASS 2	11.85" X 4.25" X 1.82"
PSRX-300W-24V		10.94" X 4.33" X 1.77"

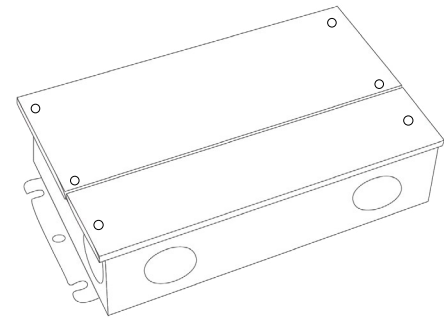

PSVT SERIES 0-10V DIMMING DRIVER

PSVT-60W-24V	CLASS 2	7.4" X 3.72" X 1.57"
PSVT-96W-24V	CLASS 2	8.66" X 3.72" X 1.57"
PSVT-200W-24V		10.24" X 4.13" X 1.77"
PSVT-288W-24V	CLASS 2	11.85" X 4.25" X 1.81"
PSVT-300W-24V		10.94" X 4.33" X 1.77"

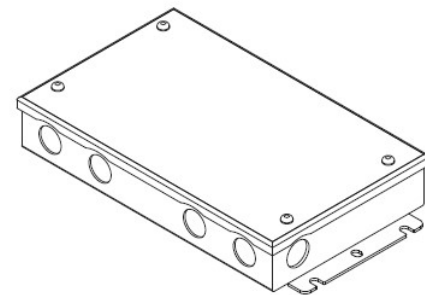

LNT-45

4.4W IP67/68 FLEXIBLE LED NEON SERIES

COMPATIBLE TRANSFORMERS

PSDE SERIES

0-10V DIMMING W/ JUNCTION BOX

PSDE-60W-24V-010-JB	CLASS 2	12.1" X 2.36" X 1.4"
PSDE-96W-24V-010-JB	CLASS 2	12.1" X 2.36" X 1.4"

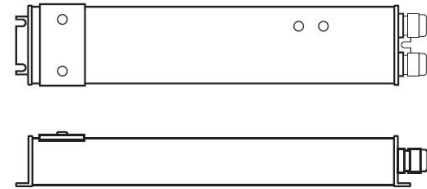

LUTRON 1%

3-WIRE DIMMING

L3DA4U1UKL-CV240	CLASS 2	4.89" X 4" X 2.62"
------------------	---------	--------------------

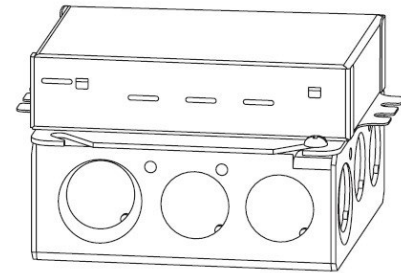

PSDE-96W-24V-ECO	CLASS 2	10.5" X 3.0" X 2.0"
------------------	---------	---------------------

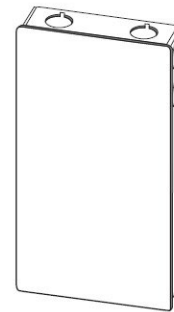

COMPATIBLE NON-DIMMING DRIVERS

PSHK SERIES

NON-DIMMING CONSTANT VOLTAGE WITH JUNCTION BOX

PSHK-30W-24V	CLASS 2	6.5" X 3.6" X 1.02"
PSHK-60W-24V	CLASS 2	7.4" X 3.62" X 1.02"
PSHK-96W-24V	CLASS 2	8.66" X 3.66" X 1.61"
PSHK-150W-24V		10.24" X 4.06" X 1.81"
PSHK-200W-24V		10.24" X 4.06" X 1.81"
PSHK-288W-24V	CLASS 2	11.85" X 4.25" X 1.82"
PSHK-300W-24V		10.24" X 4.25" X 1.81"

