

LNT-45

4.4W IP65 FLEXIBLE LED NEON SERIES

Project _____
Location _____
Quote/ Ref # _____

LNT45 is a high performance flexible LED fixture designed as a neon replacement. Suitable for indoor and outdoor applications, the LNT45 easily bends around contours and tight curves without being damaged. It allows for easy installation with its factory sealed terminators and self-locking male and female barrel connectors.

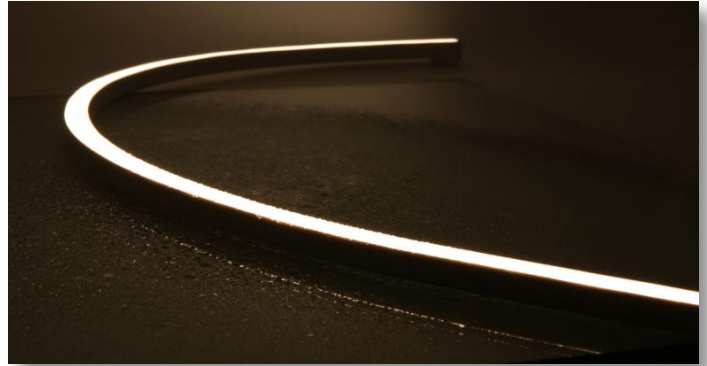

SPECIFICATIONS

INPUT VOLTAGE	24V DC Constant Voltage
POWER CONSUMPTION	4.4W per Ft.
LUMEN OUTPUT	140 Lm/ Ft.
CRI	88+
COLOR TEMPERATURE	27K/ 30K/ 40K/ BL
DIMMING/ CONTROL	MLV, ELV, 0-10 and TRIAC
MAXIMUM RUN LENGTH	32 Ft.
CUT POINT	Every 83.3mm (3.28 in)
POWER FACTOR	≤ 1
STORAGE TEMPERATURE	-40°F (-40°C) to 140°F (60°C)
OPERATING TEMPERATURE	-40°F (-40°C) to 131°F (55°C)
BEAM ANGLE	160°
HUMIDITY	0-95% Non Condensing
IP RATING	IP65
CERTIFICATIONS	UL Listed
LUMEN MAINTENANCE	50,000 Hrs.

FEATURES

- High color consistency
- Smooth illumination
- Continuous run length up to 32 Ft.
- Dimmable with CORE dimmable drivers
- UL Listed (US and Canada)

* This product is factory-cut only. Do not field modify.



MODEL	LENS	COLOR TEMP	VOLTAGE	LENGTH (PF)	POWER FEED	FEED LENGTH
LNT-45	F Flat	27K 2700K	24 24V DC	Please refer to page 4 for exact lengths with corresponding ordering codes.	IP65EF End Feed	HW36 36 In. Power Feed
		30K 3000K				HW120 120 In. Power Feed
		40K 4000K				
		BL Blue				

LNT-45

4.4W IP65 FLEXIBLE LED NEON SERIES

DIMENSIONS

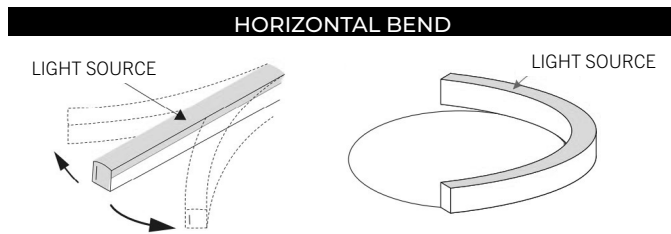
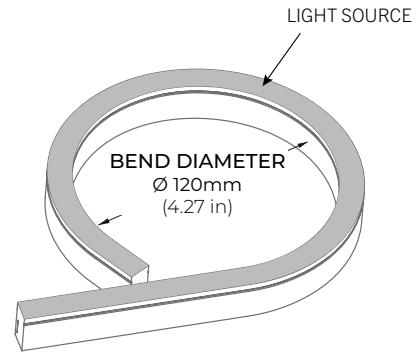
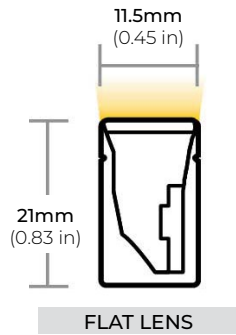

* LED strip only bends along horizontal axis. Bending the LED strip vertically (perpendicular) to the light surface risks damage to the LED strip. Do **NOT** bend more than the indicated bend radius (shown above). Doing so will damage the LED strip.

COMPATIBLE ACCESSORIES

SELF LOCKING ALUMINUM PROFILE

LNT45-AC2
1.38" PROFILE

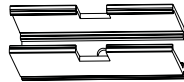

LNT45-AC2



LNT45-AC39

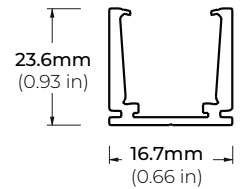

FLEXIBLE ALUMINUM CHANNEL

LNT45-AFX
39" CHANNEL

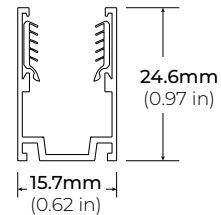
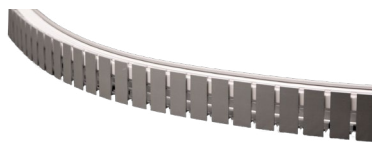

LNT45-BKT-ADJ
ADJUSTABLE BRACKET

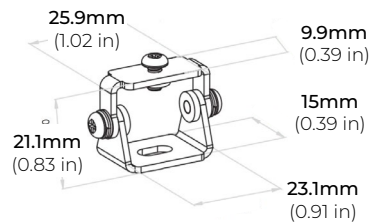

LNT-45

4.4W IP65 FLEXIBLE LED NEON SERIES

POWER FEED

IP65EF
END FEED

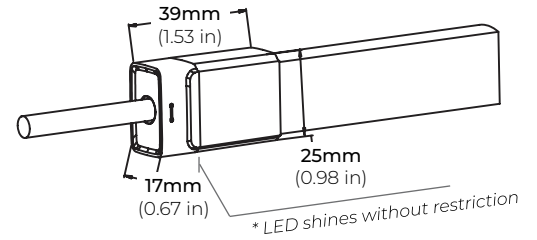

IP65EC
END CAP

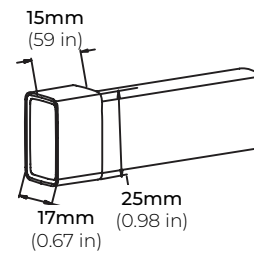

LNT-45

4.4W IP65 FLEXIBLE LED NEON SERIES

CUTTING LENGTH CODES

LNT-45 Series is cuttable every **3.28" (8.33CM)**. Please refer to the chart below to determine actual lengths once LED is cut versus actual lengths required or specified.

Total Length Calculation = Order Code Length + End Feed option Length
Example: 50.73" Total Length = Order Code 15 (49.2") + (1.53") End Feed

POWER FEED OPTION	LENGTH
END FEED	1.53 INCHES

CUTTING LENGTH INCREMENT TABLE

CODE	LENGTH (CM)	LENGTH (IN)
1	8.33	3.28
2	16.66	6.56
3	24.99	9.84
4	33.32	13.12
5	41.65	16.4
6	49.98	19.68
7	58.31	22.96
8	66.64	26.24
9	74.97	29.52
10	83.3	32.8
11	91.63	36.08
12	99.96	39.36
13	108.29	42.64
14	116.62	45.92
15	124.95	49.2
16	133.28	52.48
17	141.61	55.76
18	149.94	59.04
19	158.27	62.32
20	166.6	65.6
21	174.93	68.88
22	183.26	72.16
23	191.59	75.44
24	199.92	78.72
25	208.25	82
26	216.58	85.28
27	224.91	88.56
28	233.24	91.84
29	241.57	95.12
30	249.9	98.4
31	258.23	101.68
32	266.56	104.96
33	274.89	108.24
34	283.22	111.52
35	291.55	114.8
36	299.88	118.08
37	308.21	121.36
38	316.54	124.64
39	324.87	127.92
40	333.2	131.2

CODE	LENGTH (CM)	LENGTH (IN)
41	341.53	134.48
42	349.86	137.76
43	358.19	141.04
44	366.52	144.32
45	374.85	147.6
46	383.18	150.88
47	391.51	154.16
48	399.84	157.44
49	408.17	160.72
50	416.5	164
51	424.83	167.28
52	433.16	170.56
53	441.49	173.84
54	449.82	177.12
55	458.15	180.4
56	466.48	183.68
57	474.81	186.96
58	483.14	190.24
59	491.47	193.52
60	499.8	196.8
61	508.13	200.08
62	516.46	203.36
63	524.79	206.64
64	533.12	209.92
65	541.45	213.2
66	549.78	216.48
67	558.11	219.76
68	566.44	223.04
69	574.77	226.32
70	583.1	229.6
71	591.43	232.88
72	599.76	236.16
73	608.09	239.44
74	616.42	242.72
75	624.75	246
76	633.08	249.28
77	641.41	252.56
78	649.74	255.84
79	658.07	259.12
80	666.4	262.4

CODE	LENGTH (CM)	LENGTH (IN)
81	674.73	265.68
82	683.06	268.96
83	691.39	272.24
84	699.72	275.52
85	708.05	278.8
86	716.38	282.08
87	724.71	285.36
88	733.04	288.64
89	741.37	291.92
90	749.7	295.2
91	758.03	298.48
92	766.36	301.76
93	774.69	305.04
94	783.02	308.32
95	791.35	311.6
96	799.68	314.88
97	808.01	318.16
98	816.34	321.44
99	824.67	324.72
100	833	328
101	841.33	331.28
102	849.66	334.56
103	857.99	337.84
104	866.32	341.12
105	874.65	344.4
106	882.98	347.68
107	891.31	350.96
108	899.64	354.24
109	907.97	357.52
110	916.3	360.8
111	924.63	364.08
112	932.96	367.36
113	941.29	370.64
114	949.62	373.92
115	957.95	377.2
116	966.28	380.48
117	974.61	383.76

LNT-45

4.4W IP65 FLEXIBLE LED NEON SERIES

COMPATIBLE TRANSFORMERS

PSDL SERIES TRIAC DIMMABLE

PSDL-30W-24V	CLASS 2	6.5" X 3.63" X 1.03"
PSDL-60W-24V	CLASS 2	7.4" X 3.63" X 1.03"
PSDL-96W-24V	CLASS 2	8.67" X 3.67 X 1.62"
PSDL-150W-24V		8.67" X 3.67" X 1.62"
PSDL-192W-24V	CLASS 2	10.25" X 4.06" X 1.82"
PSDL-200W-24V		10.25" X 4.06" X 1.82"
PSDL-288W-24V	CLASS 2	10.25" X 4.06" X 1.82"
PSDL-300W-24V		10.25" X 4.06" X 1.82"

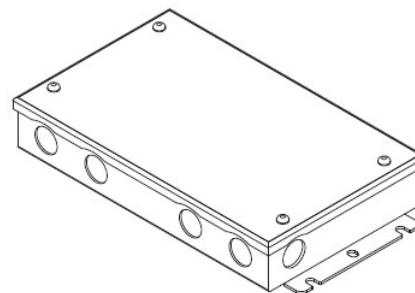

PSDH SERIES HIGH PERFORMANCE MAGNETIC LOW VOLTAGE (MLV)

PSDH-48W-24V	CLASS 2	11.25" X 3.37" X 3.25"
PSDH-96W-24V	CLASS 2	11.25" X 3.37" X 3.25"
PSDH-288W-24V	CLASS 2	14.25" X 8.43" X 4.43"

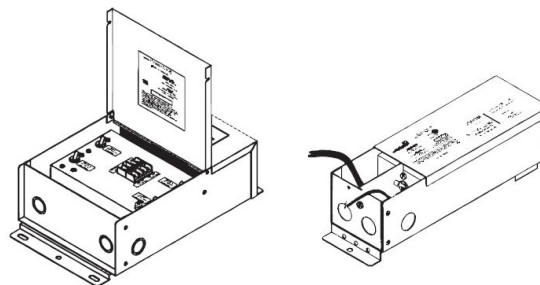

PSRX SERIES 4-IN-1 DIMMING DRIVER

PSRX-30W-24V	CLASS 2	6.5" X 3.72" X 1.57"
PSRX-60W-24V	CLASS 2	7.4" X 3.72" X 1.57"
PSRX-96W-24V	CLASS 2	8.66" X 3.72" X 1.57"
PSRX-150W-24V		10.24" X 4.13" X 1.77"
PSRX-192W-24V	CLASS 2	11" X 4" X 1.82"
PSRX-200W-24V		10.24" X 4.13" X 1.77"
PSRX-288W-24V	CLASS 2	11.85" X 4.25" X 1.82"
PSRX-300W-24V		10.94" X 4.33" X 1.77"

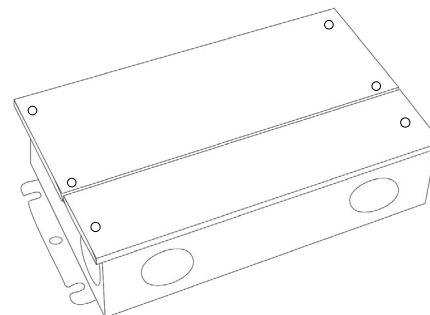

PSVT SERIES 0-10V DIMMING DRIVER

PSVT-60W-24V	CLASS 2	7.4" X 3.72" X 1.57"
PSVT-96W-24V	CLASS 2	8.66" X 3.72" X 1.57"
PSVT-200W-24V		10.24" X 4.13" X 1.77"
PSVT-288W-24V	CLASS 2	11.85" X 4.25" X 1.81"
PSVT-300W-24V		10.94" X 4.33" X 1.77"

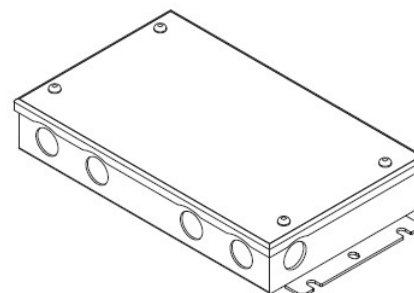

LNT-45

4.4W IP65 FLEXIBLE LED NEON SERIES

COMPATIBLE TRANSFORMERS

PSDE SERIES

0-10V DIMMING W/ JUNCTION BOX

PSDE-60W-24V-010-JB	CLASS 2	12.1" X 2.36" X 1.4"
PSDE-96W-24V-010-JB	CLASS 2	12.1" X 2.36" X 1.4"

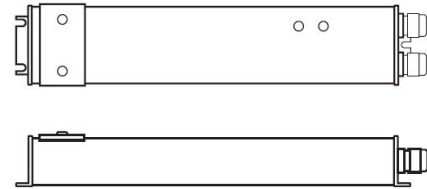

LUTRON 1%

3-WIRE DIMMING

L3DA4U1UKL-CV240	CLASS 2	4.89" X 4" X 2.62"
------------------	---------	--------------------

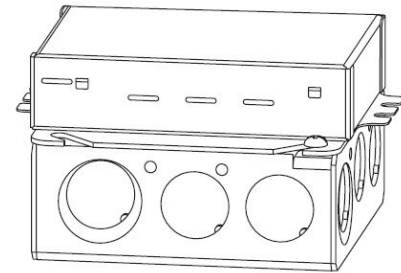

PSDE-96W-24V-ECO	CLASS 2	10.5" X 3.0" X 2.0"
------------------	---------	---------------------

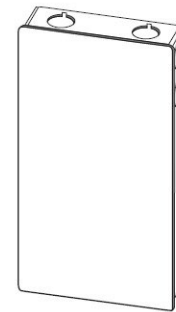

COMPATIBLE NON-DIMMING DRIVERS

PSHK SERIES

NON-DIMMING CONSTANT VOLTAGE WITH JUNCTION BOX

PSHK-30W-24V	CLASS 2	6.5" X 3.6" X 1.02"
PSHK-60W-24V	CLASS 2	7.4" X 3.62" X 1.02"
PSHK-96W-24V	CLASS 2	8.66" X 3.66" X 1.61"
PSHK-150W-24V		10.24" X 4.06" X 1.81"
PSHK-200W-24V		10.24" X 4.06" X 1.81"
PSHK-288W-24V	CLASS 2	11.85" X 4.25" X 1.82"
PSHK-300W-24V		10.24" X 4.25" X 1.81"

