

# LNT-20 HB/VB SERIES

## 1.5W IP65 FLEXIBLE LED NEON SERIES

Project \_\_\_\_\_  
Location \_\_\_\_\_  
Quote/ Ref # \_\_\_\_\_

The **LNT-20HB/VB** is a high performance, flexible LED strip designed as a neon replacement, useful in a wide variety of indoor or outdoor applications where a smooth surface or continuous line of light is desired. It can bend around contours or tight curves horizontally or vertically without being damaged. It allows for easy installation with its factory sealed terminators and self locking male and female barrel connectors. Fully encapsulated UV protected and wet location rated.

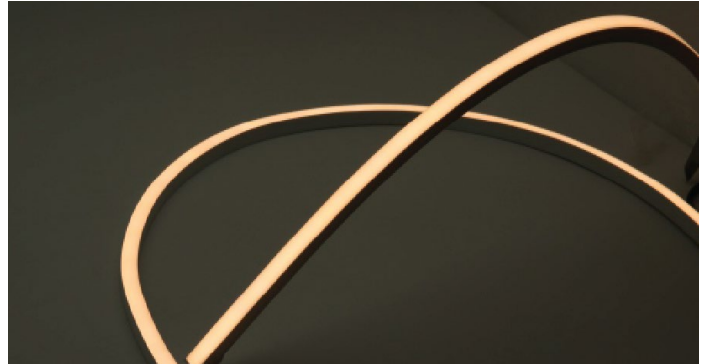

### SPECIFICATIONS

<b>INPUT VOLTAGE</b>	24V DC Constant Voltage
<b>POWER CONSUMPTION</b>	1.5W per Ft.
<b>LUMEN OUTPUT</b>	47Lm/Ft.
<b>CRI</b>	90+
<b>COLOR TEMPERATURE</b>	22K/ 24K/ 27K/ 30K/ 35K/ 40K/ 50K/ RD/ GN/ BL/ AM
<b>DIMMING/ CONTROL</b>	MLV, ELV, 0-10V and TRIAC
<b>MAXIMUM RUN LENGTH</b>	32 Ft.
<b>CUTTABLE</b>	Every 83.3mm (3.28 in)
<b>POWER FACTOR</b>	≤ 1
<b>STORAGE TEMPERATURE</b>	-40°F (-40°C) to 140°F (60°C)
<b>OPERATING TEMPERATURE</b>	-40°F (-40°C) to 131°F (55°C)
<b>BEAM ANGLE</b>	160°
<b>HUMIDITY</b>	0-95% Non Condensing
<b>IP RATING</b>	IP65
<b>CERTIFICATIONS</b>	UL Listed
<b>LUMEN MAINTENANCE</b>	50,000 Hrs.

### FEATURES

- High color consistency
- Multiple CCT options available
- Ideal for indoor and outdoor use
- Continuous run length up to 32 Ft.
- Dimmable with CORE dimmable drivers
- UL Listed (US and Canada)



MODEL	SURFACE	COLOR TEMP	VOLTAGE	LENGTH (PF)	POWER FEED	FEED LENGTH		
LNT-20	HB Horizontal Bend	22K	RD*	24 24V DC	Please refer to page 4 for exact lengths with corresponding ordering codes.	IP65BF Bottom Feed	HW3 3' Power Feed	
		24K	GN*				HW10 10' Power Feed	
		27K	BL*				HW16 16' Power Feed	
		30K	AM*				HW32 32' Power Feed	
		35K					HW50 50' Power Feed	
	VB Vertical Bend	27K	BL*				IP65SFL Side Feed Left	
		30K	AM*				IP65SFR Side Feed Right	
		35K					IP65EF End Feed	
		40K						
		50K						

# LNT-20 HB/VB SERIES

## 1.5W IP65 FLEXIBLE LED NEON SERIES

### DIMENSIONS

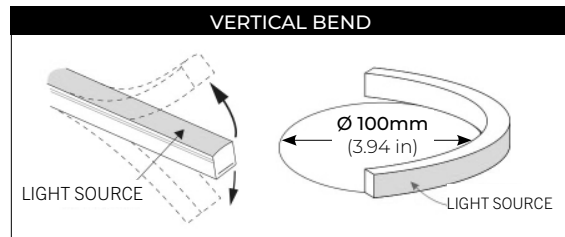
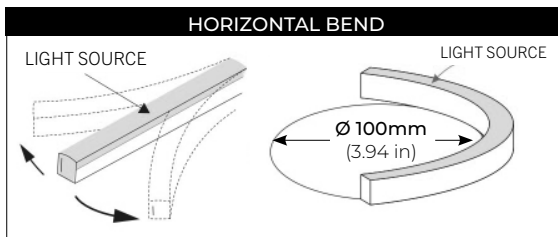
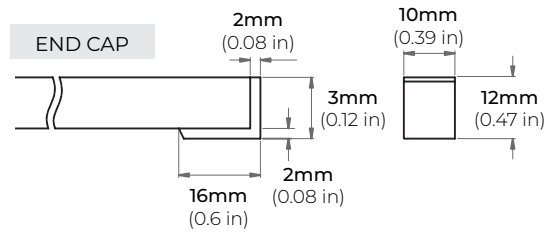
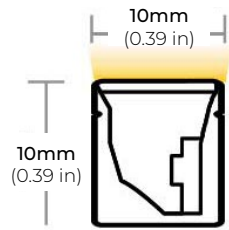

### MOUNTING ACCESSORIES

#### ALUMINUM PROFILE

LNT20-AC2  
0.8" PROFILE

LNT20-AC39  
39" PROFILE

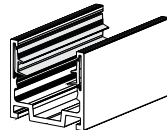

LNT20-AC2

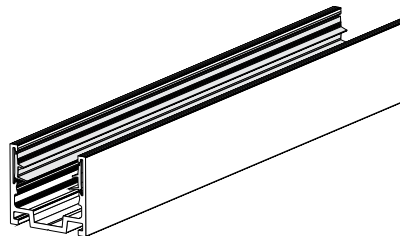

LNT20-AC39

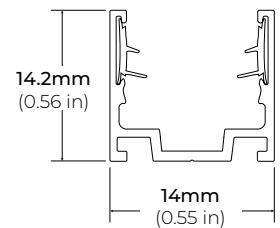

#### FLEXIBLE ALUMINUM PROFILE

LNT20-AFX  
39" PROFILE

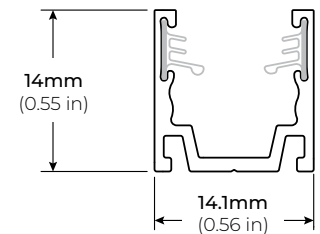
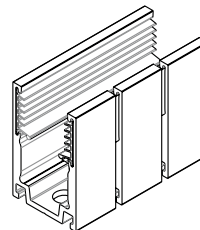

# LNT-20 HB/VB SERIES

## 1.5W IP65 FLEXIBLE LED NEON SERIES

### IP65 POWER FEED

IP65EF  
END FEED

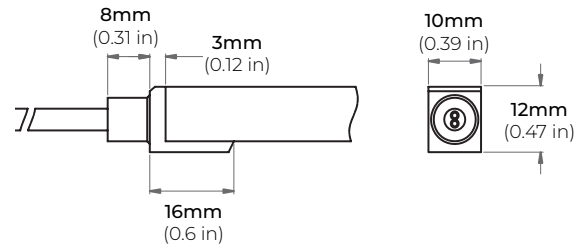

IP65SFL  
SIDE FEED LEFT

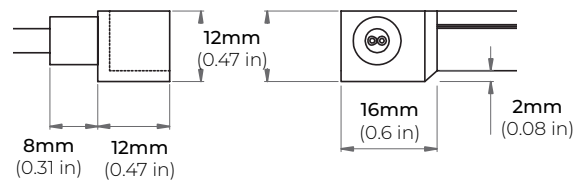

IP65SFR  
SIDE FEED RIGHT

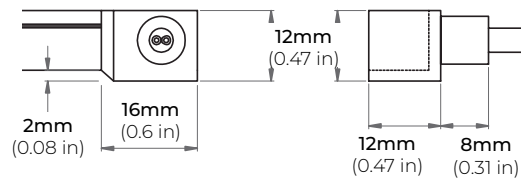

IP65BF  
BOTTOM FEED

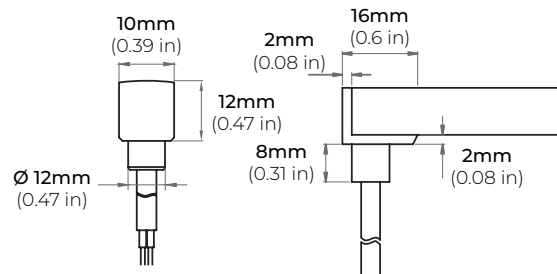

# LNT-20 HB/VB SERIES

## 1.5W IP65 FLEXIBLE LED NEON SERIES

### CUTTING LENGTH CODES

LNT-20 is **FACTORY CUT ONLY** every 3.28" (8.33CM). Please refer to the chart below to determine actual lengths once LED is cut versus actual lengths required or specified.

Total Length Calculation = Order Code Length + End Feed option Length  
**Example: 49.8" Total Length = Order Code 15 (49.2) + (0.60") IP65 Side Feed**

POWER FEED OPTION	IP65
END FEED	0.91"
BOTTOM FEED	0.60"
SIDE FEED	0.60"

### CUTTING LENGTH INCREMENT TABLE

CODE	LENGTH (CM)	LENGTH (IN)
1	8.33	3.28
2	16.66	6.56
3	24.99	9.84
4	33.32	13.12
5	41.65	16.4
6	49.98	19.68
7	58.31	22.96
8	66.64	26.24
9	74.97	29.52
10	83.3	32.8
11	91.63	36.08
12	99.96	39.36
13	108.29	42.64
14	116.62	45.92
15	124.95	49.2
16	133.28	52.48
17	141.61	55.76
18	149.94	59.04
19	158.27	62.32
20	166.6	65.6
21	174.93	68.88
22	183.26	72.16
23	191.59	75.44
24	199.92	78.72
25	208.25	82
26	216.58	85.28
27	224.91	88.56
28	233.24	91.84
29	241.57	95.12
30	249.9	98.4
31	258.23	101.68
32	266.56	104.96
33	274.89	108.24
34	283.22	111.52
35	291.55	114.8
36	299.88	118.08
37	308.21	121.36
38	316.54	124.64
39	324.87	127.92
40	333.2	131.2

CODE	LENGTH (CM)	LENGTH (IN)
41	341.53	134.48
42	349.86	137.76
43	358.19	141.04
44	366.52	144.32
45	374.85	147.6
46	383.18	150.88
47	391.51	154.16
48	399.84	157.44
49	408.17	160.72
50	416.5	164
51	424.83	167.28
52	433.16	170.56
53	441.49	173.84
54	449.82	177.12
55	458.15	180.4
56	466.48	183.68
57	474.81	186.96
58	483.14	190.24
59	491.47	193.52
60	499.8	196.8
61	508.13	200.08
62	516.46	203.36
63	524.79	206.64
64	533.12	209.92
65	541.45	213.2
66	549.78	216.48
67	558.11	219.76
68	566.44	223.04
69	574.77	226.32
70	583.1	229.6
71	591.43	232.88
72	599.76	236.16
73	608.09	239.44
74	616.42	242.72
75	624.75	246
76	633.08	249.28
77	641.41	252.56
78	649.74	255.84
79	658.07	259.12
80	666.4	262.4

CODE	LENGTH (CM)	LENGTH (IN)
81	674.73	265.68
82	683.06	268.96
83	691.39	272.24
84	699.72	275.52
85	708.05	278.8
86	716.38	282.08
87	724.71	285.36
88	733.04	288.64
89	741.37	291.92
90	749.7	295.2
91	758.03	298.48
92	766.36	301.76
93	774.69	305.04
94	783.02	308.32
95	791.35	311.6
96	799.68	314.88
97	808.01	318.16
98	816.34	321.44
99	824.67	324.72
100	833	328
101	841.33	331.28
102	849.66	334.56
103	857.99	337.84
104	866.32	341.12
105	874.65	344.4
106	882.98	347.68
107	891.31	350.96
108	899.64	354.24
109	907.97	357.52
110	916.3	360.8
111	924.63	364.08
112	932.96	367.36
113	941.29	370.64
114	949.62	373.92
115	957.95	377.2
116	966.28	380.48
117	974.61	383.76

# LNT-20 HB/VB SERIES

## 1.5W IP65 FLEXIBLE LED NEON SERIES

### COMPATIBLE TRANSFORMERS

#### PSDL SERIES TRIAC DIMMABLE

PSDL-30W-24V	CLASS 2	6.5" X 3.63" X 1.58"
PSDL-60W-24V	CLASS 2	7.4" X 3.63" X 1.58"
PSDL-96W-24V	CLASS 2	8.67" X 3.67 X 1.62"
PSDL-150W-24V		10.25" X 4.06" X 1.82"
PSDL-192W-24V	CLASS 2	11" X 4" X 1.82"
PSDL-200W-24V		10.25" X 4.06" X 1.82"
PSDL-288W-24V	CLASS 2	11.85" X 4.25" X 1.82"
PSDL-300W-24V		10.25" X 4.06" X 1.82"

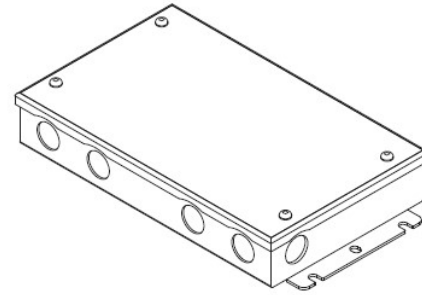

#### PSDH SERIES HIGH PERFORMANCE MAGNETIC LOW VOLTAGE (MLV)

PSDH-48W-24V	CLASS 2	11.25" X 3.38" X 3.38"
PSDH-96W-24V	CLASS 2	11.25" X 3.38" X 3.37"
PSDH-288W-24V	CLASS 2	14.25" X 8.43" X 4.43"

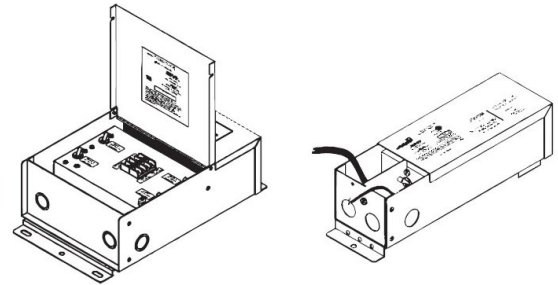

#### PSRX SERIES 4-IN-1 DIMMING DRIVER

PSRX-30W-24V	CLASS 2	6.5" X 3.72" X 1.57"
PSRX-60W-24V	CLASS 2	7.4" X 3.72" X 1.57"
PSRX-96W-24V	CLASS 2	8.66" X 3.72" X 1.57"
PSRX-150W-24V		10.24" X 4.13" X 1.77"
PSRX-192W-24V	CLASS 2	11" X 4" X 1.82"
PSRX-200W-24V		10.24" X 4.13" X 1.77"
PSRX-288W-24V	CLASS 2	11.85" X 4.25" X 1.82"
PSRX-300W-24V		10.94" X 4.33" X 1.77"

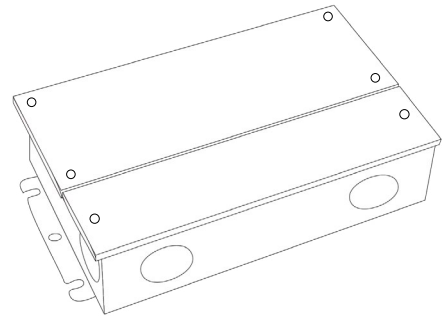

#### PSVT SERIES 0-10V DIMMING WITH JUNCTION BOX

PSVT-60W-24V-UNV-010	CLASS 2	7.4" X 3.72" X 1.57"
PSVT-96W-24V-UNV-010	CLASS 2	8.66" X 3.72" X 1.57"
PSVT-200W-24V-UNV-010		10.24" X 4.13" X 1.77"
PSVT-288W-24V-UNV-010	CLASS 2	11.85" X 4.25" X 1.81"
PSVT-300W-24V-UNV-010		10.94" X 4.33" X 1.77"

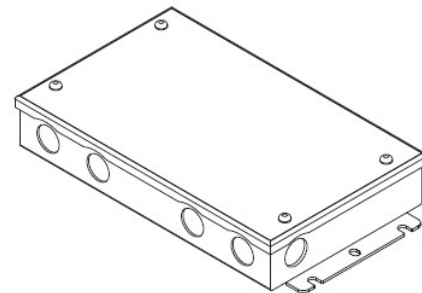

# LNT-20 HB/VB SERIES

## 1.5W IP65 FLEXIBLE LED NEON SERIES

### COMPATIBLE TRANSFORMERS

#### PSDE SERIES

0-10V DIMMING W/ JUNCTION BOX

PSDE-60W-24V-010-JB	CLASS 2	12.1" X 2.36" X 1.4"
PSDE-96W-24V-010-JB	CLASS 2	12.1" X 2.36" X 1.4"

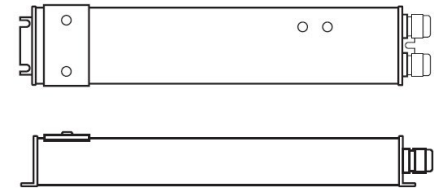

#### LUTRON 1%

3-WIRE DIMMING

L3DA4U1UKL-CV240	CLASS 2	4.89" X 4" X 2.62"
------------------	---------	--------------------

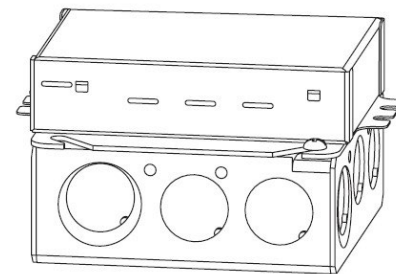

PSDE-96W-24V-ECO	CLASS 2	10.5" X 3.0" X 2.0"
------------------	---------	---------------------

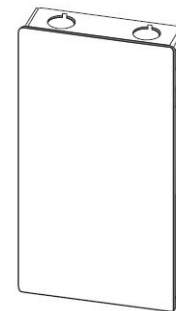

### COMPATIBLE NON-DIMMING DRIVERS

#### PSHK SERIES

NON-DIMMING CONSTANT VOLTAGE WITH JUNCTION BOX

PSHK-30W-24V	CLASS 2	6.5" X 3.6" X 1.02"
PSHK-60W-24V	CLASS 2	7.4" X 3.62" X 1.02"
PSHK-96W-24V	CLASS 2	8.66" X 3.66" X 1.61"
PSHK-150W-24V		10.24" X 4.06" X 1.81"
PSHK-200W-24V		10.24" X 4.06" X 1.81"
PSHK-288W-24V	CLASS 2	11.85" X 4.25" X 1.82"
PSHK-300W-24V		10.24" X 4.25" X 1.81"

