

# LWW120-SL-RGBW

## 120V-277V HIGH-OUTPUT COLOR-CHANGING LED WALL WASHER

Project \_\_\_\_\_

Location \_\_\_\_\_

Quote/ Ref # \_\_\_\_\_

**LWW120-SL-RGBW** Linear Wall washer series is a powerful 120V color-changing LED flood light typically used for building facades, signs or any wall washing application Available in multiple optical lens options to provide endless lighting solutions. Available in narrow, medium, wide and elliptical optic options.



### SPECIFICATIONS

INPUT VOLTAGE	120-277 AC
OPERATING FREQUENCY	50/ 60 Hz
POWER CONSUMPTION	9W/ Ft.
LUMEN OUTPUT	270 Lm./ FT. (RGBW)
COLOR TEMPERATURE	RGB/ RGB+30K/ RGB+40K/ RGB+65K
BEAM ANGLE	10°/ 25°/ 35°/ 20° x 50°
MAX RUN	Linkable up to 28 ft.
CRI	90+
DIMMING	DMX
HOUSING	Extruded Aluminum
IP RATING	IP66 Outdoor/ Wet Location
CERTIFICATIONS	ETL Listed
LUMEN MAINTENANCE	70,000 Hrs.
WARRANTY	5-Year Limited

### FEATURES

- 90+ CRI
- Multiple beam angles
- Multiple CCT options available
- ETL Listed



MODEL	LENGTH	COLOR TEMP	OPTICS	MOUNTING	FINISH	OPTIONS	VOLTAGE
LWW120-SL	<b>24</b> 23.62 in (18W)	<b>RGB</b> RGB	<b>10</b> 10°	<b>STB</b> Standard Tilting Bracket	<b>TG</b> Titanium Grey	<b>ADLV</b> Asymmetric Anti-Glare Louver	<b>UNV</b> 120V-277V
	<b>48</b> 47.24 in (36W)	<b>RGBW30K</b> RGB+3000K	<b>25</b> 25°	<b>STK</b> Mounting Stake	<b>BK</b> Black	<b>SDLV</b> Symmetric Anti-Glare Louver	
		<b>RGBW40K</b> RGB+4000K	<b>35</b> 35°	<b>WMS</b> Small Wall Mount Arms	<b>WH</b> White		
		<b>RGBW65K</b> RGB+6500K	<b>2050</b> 20° x 50°	<b>WML</b> Large Wall Mount Arms			

# LWW120-SL-RGBW

120V-277V HIGH-OUTPUT COLOR-CHANGING LED WALL WASHER

UPDATED: 07.15.25

## DIMENSIONS

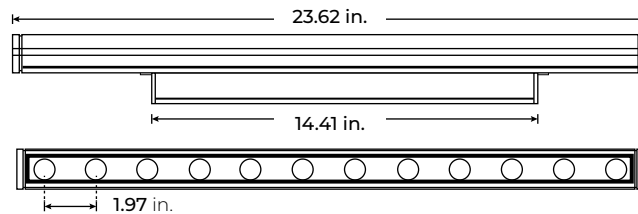
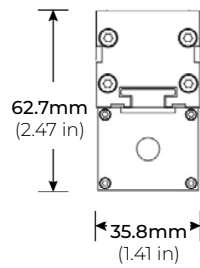

LWW120-SL-24

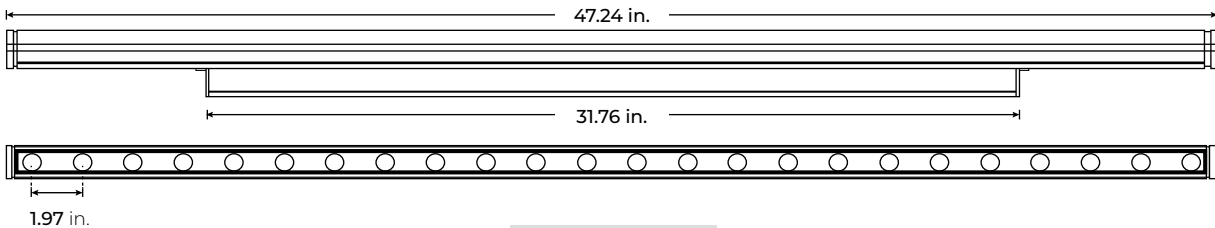

LWW120-SL-48

## OPTICS



10°

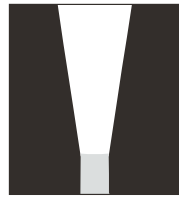

25°

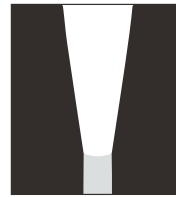

35°

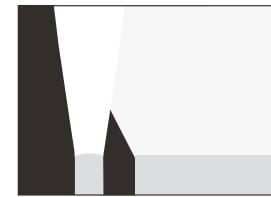

20° x 50°

# LWW120-SL-RGBW

120V-277V HIGH-OUTPUT COLOR-CHANGING LED WALL WASHER

## MOUNTING ACCESSORIES

**LWW120-STB**  
STANDARD TILTING BRACKET  
\*Included with every Fixture

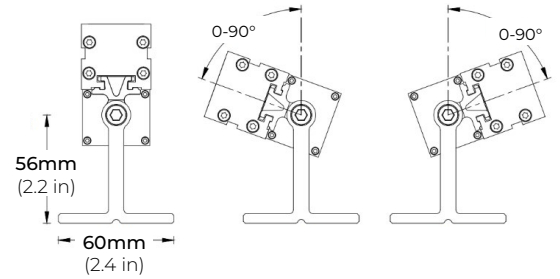

**LWW120-STK**  
MOUNTING STAKE  
\*Sold Separately

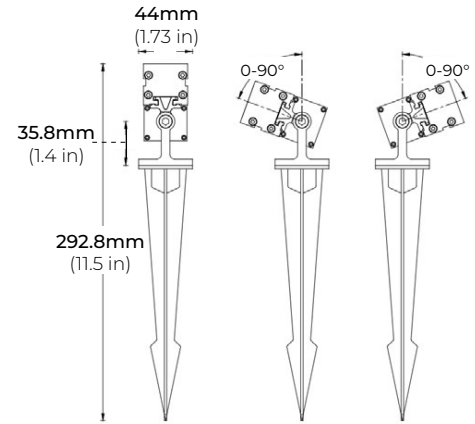

**LWW-WMS**  
SMALL WALL MOUNT ARM (6-9")  
\*Sold Separately



Adjustable Length Wall to Fixture

Small Mounting Arm: 6-9 in.  
Large Mounting Arm: 14-22 in.

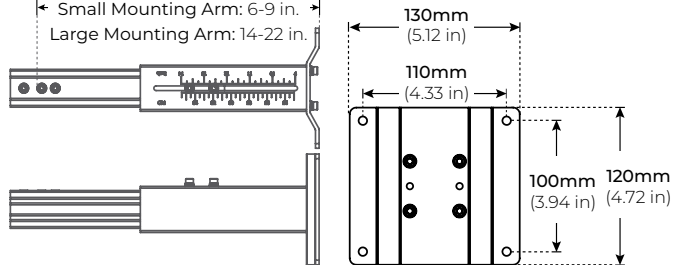

**LWW-WML**  
LARGE WALL MOUNT ARM (14-22")  
\*Sold Separately

# LWW120-SL-RGBW

## 120V-277V HIGH-OUTPUT COLOR-CHANGING LED WALL WASHER

### COMPATIBLE ACCESSORIES

#### LWW120-EC

END CAP

\*Sold Separately

\*One end cap required per run length

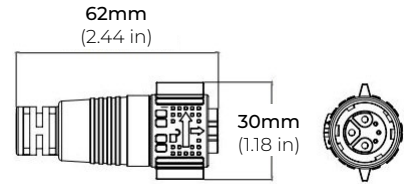

#### LWW120-SL-24-ADLV

LWW120-SL-48-ADLV

24" AND 48" ASYMMETRIC LOUVER

\*Sold Separately

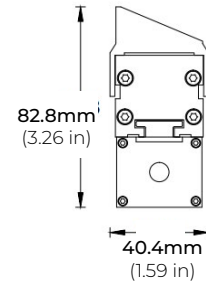
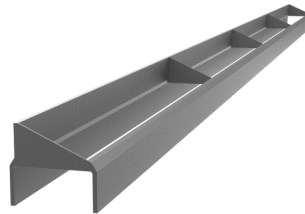

#### LWW120-SL-24-SDLV

LWW120-SL-48-SDLV

24" AND 48" SYMMETRIC LOUVER

\*Sold Separately

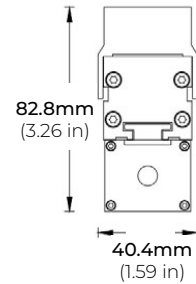
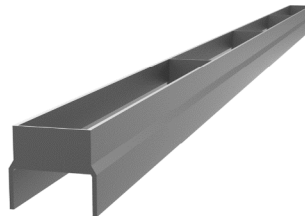

#### LWW120-LNK-10

LWW120-LNK-36

LWW120-LNK-72

10", 36", 72" LINK EXTENSION CABLE

\*Sold Separately



#### LWW120-HWC-72

LWW120-HWC-120

72" AND 120" HARDWIRE CABLE

\*Sold Separately

