

CSL-135

INDOOR SUSPENDED LED LUMINAIRE

Project _____

Location _____

Quote/ Ref # _____

CSL-135 is an Architectural Grade LED luminaire made of premium aluminum, offering excellent thermal management for LED strips with higher wattages and extends the total life of your lighting system. Manufactured with a patented frosted diffuser for maximum lumen output and wide beam distribution, this fixture also protects LED's from dust and other undesirable elements, which can shorten the lifetime of the LED.



SPECIFICATIONS

TYPE	Suspended
INPUT VOLTAGE	24V
WATTAGE	5W/ Ft. 7W/ Ft.
LUMEN OUTPUT	500 ~ 750 Lm/ Ft. (30K)
COLOR TEMPERATURE	27K/ 30K/ 35K/ 40K/ 50K/ 60K/ RD/ GN/BL/ AM/ PK/ YW/ RGB27K/ RGB30K/ RGB40K/ RGB
LENS OPTION	Frosted
AVAILABLE LENGTHS	48 in./ 96 in.
DIMMING	MLV, ELV, 0-10, TRIAC and DMX
FINISH	White, Black, Silver
TRANSFORMER	Remote
CHANNEL	CSL135
LENS (INCLUDED)	CSL135-LN
SUSPENSION KIT	ALP-CS12

FEATURES

- Customizable
- Durable, military grade aluminum
- Protects LED systems from dust and other elements
- Dissipates heat from LED, prolonging its lifetime

LUMENS

TYPE	W/ FT.	LM/ FT.
L1	5W/ Ft.	500
L2	7W/ Ft.	750



MODEL	LENGTH	WATTAGE	COLOR TEMP			FINISH	DRIVER
CSL135	4 4 Ft.	L1 5W	27K 2700K	RD* Red	RGBW27K RGB+27K	WH White	<i>See Page 4-9 for compatible drivers.</i>
	8 8 ft.		L2 7W	30K 3000K	GN* Green	RGBW30K RGB+30K	
	PF Custom Length	35K 3500K		BL Blue	RGBW40K RGB+40K	Si Silver	
		40K 4000K		AM* Amber	RGB RGB		
		50K 5000K		PK* Pink			
		60K 6000K	YW* Yellow				
	* Custom length per FT. (8Ft. Max)		* Available only in 5W				

CSL-135

INDOOR SUSPENDED LED LUMINAIRE

DIMENSIONS

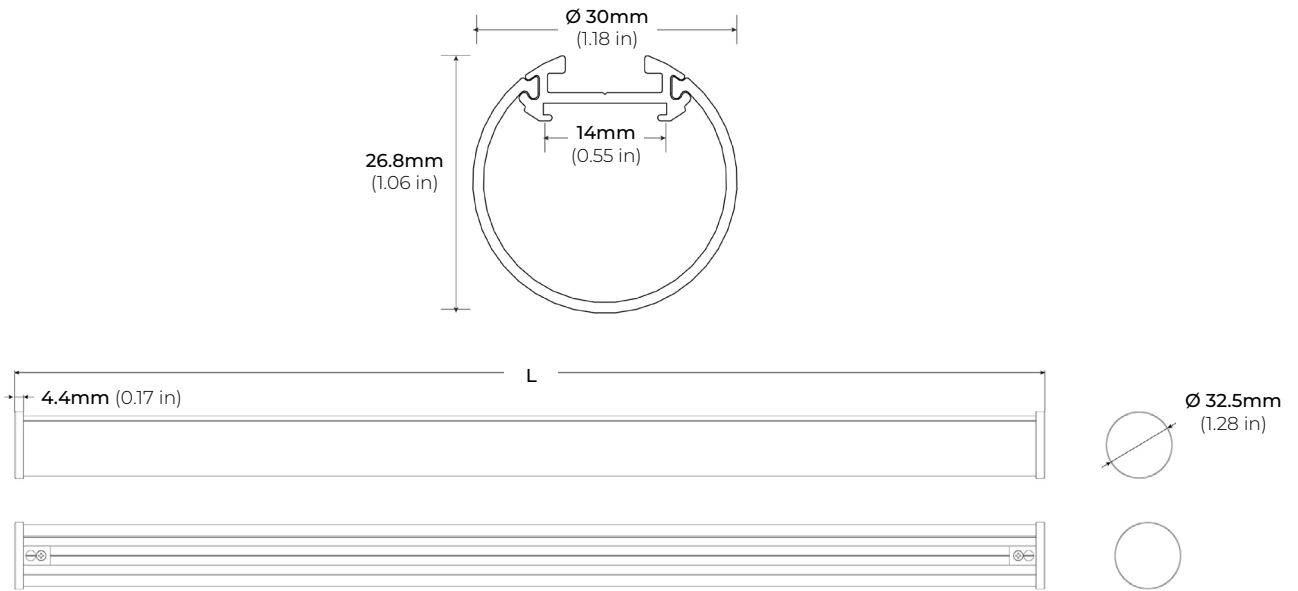

COMPATIBLE ACCESSORIES

ALP135-SC-WH
CONNECTOR BRACKET (WHITE)

ALP135-SC-BK
CONNECTOR BRACKET (BLACK)

ALP135-SC-SI
CONNECTOR BRACKET (SILVER)

* SOLD SEPARATELY

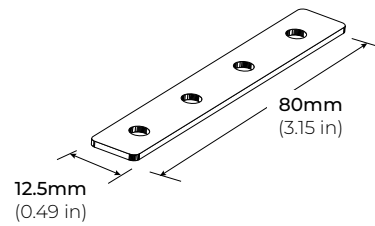

MOUNTING ACCESSORIES

ALP-CS12
EUROPEAN SUSPENSION KIT

* STANDARD SUSPENSION CABLE LENGTH OF 10FT.

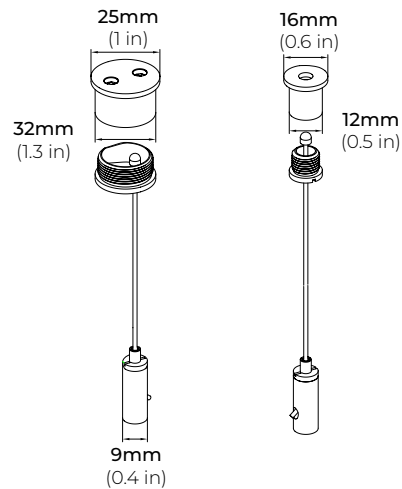

CSL-135

INDOOR SUSPENDED LED LUMINAIRE

SUSPENSION KIT ACCESSORIES

* STANDARD SUSPENSION CABLE LENGTH IS 10FT.

POWER FEED KIT

ALP-CF-WH
WHITE POWER FEED KIT

ALP-CF-BK
BLACK POWER FEED KIT

*SOLD SEPARATELY

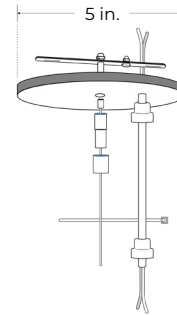

2" NON-POWER FEED KIT

ALP-CSB-WH-2
2" WHITE FEED KIT

ALP-CSB-BK-2
2" BLACK FEED KIT

*SOLD SEPARATELY

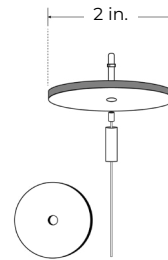

5" NON-POWER FEED KIT

ALP-CSB-WH-5
5" WHITE FEED KIT

ALP-CSB-BK-5
5" BLACK FEED KIT

*SOLD SEPARATELY

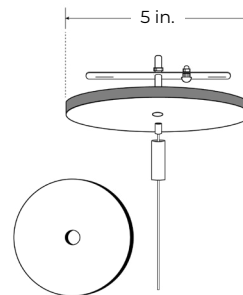

CSL-135

INDOOR SUSPENDED LED LUMINAIRE

DMX CONTROLLERS

All DMX Controllers require a DMX Decoder and Non-Dimming Driver.
Please refer for page 7 and 9 for compatible options.

RGB CT600 MULTI-FUNCTION RGBW WALL CONTROLLER

INPUT VOLTAGE 5V DC, 1A
OUTPUT SIGNAL RF 2.4GHZ + DMX512
CONTROL 4 ZONES
COLOR OPTIONS Black/ White
WORKING TEMP -20°C ~ 40°C
DIMENSIONS LxWxH (5.19"x7.08"x1.38")

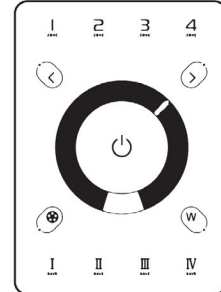

RGB-SCW4 WiFi DMX WALL CONTROLLER

INPUT VOLTAGE 5 - 10V DC, 06A
OUTPUT SIGNAL DMX512 (x2)
PROGRAMMABILITY PC/ MAC
COLOR OPTIONS Black/ White
CONNECTIONS USB/ 8dry contact ports/ Open drain output (for relay)
MEMORY Built-In Flash
WORKING TEMP -10°C ~ 45°C
DIMENSIONS LxWxH (5.75"x4.17"x0.43")

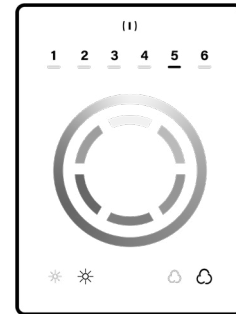

RGB-SDE3 WiFi DMX WALL CONTROLLER

INPUT VOLTAGE 6V DC, 0.6A
OUTPUT SIGNAL DMX512 (x2)
PROGRAMMABILITY PC/ MAC/ Tablet/ Smartphone
COLOR OPTIONS Black/ White
CONNECTIONS USB/ Ethernet/ RS232/ CLock/ 8dry contact ports/ 5V output relay
MEMORY MicroSD Card
WORKING TEMP -20°C ~ 40°C
DIMENSIONS LxWxH (5.75"x4.17"x0.43")

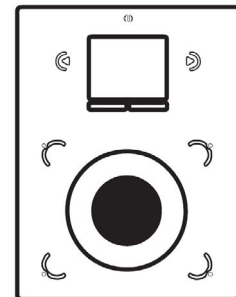

CSL-135

INDOOR SUSPENDED LED LUMINAIRE

DMX DECODERS

All DMX Decoders require a DMX Controller and Non-Dimming Driver.
Please refer for page 6 and 9 for compatible options.

RGB-DMX-4C-RJ45 4-CHANNEL DMX DECODER

INPUT VOLTAGE 12V-24V DC
OUTPUT CURRENT 8A X 4CH
OUTPUT WATTAGE 4 x (96W ~ 288W)
OUTPUT CHANNELS 4
DIMENSIONS LxWxH (6.5"x2.38"x1.27")

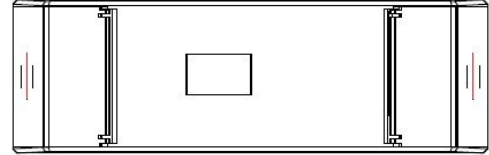

RGB-DMX-5C-XLR 5-CHANNEL DMX DECODER

INPUT VOLTAGE 12V-24V DC
OUTPUT CURRENT 8A X 5CH
OUTPUT WATTAGE 5 x (96W ~ 192W)
OUTPUT CHANNELS 5
DIMENSIONS LxWxH (6.45"x2.87"x1.5")

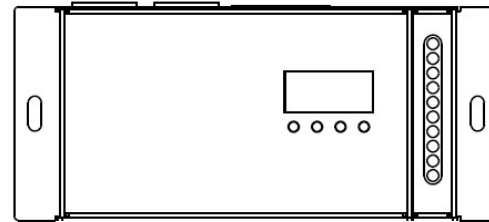

CSL-135

INDOOR SUSPENDED LED LUMINAIRE

NON-DMX CONTROLLERS

RGB-CT550

RGBW WIRELESS RECEIVER / CONTROLLER SYSTEM

REMOTE DISTANCE	100 Ft. (Line of Sight)
FREQUENCY	2.4 GHz
DIMENSIONS	LxWxH (6.38"x1.65"x0.59")
WEIGHT	0.44lbs.

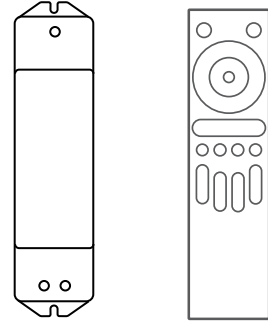

* RGB-CT500-RX
(Sold Separately)

RGB-CT550-RX

RGBW WIRELESS RECEIVER / CONTROLLER SYSTEM

INPUT VOLTAGE	DC5V ~ DC24V
POWER CAPACITY	100W (5V) 240W (12V) 480W (24V)
OUTPUT CURRENT	5A per Channel (20A Total)
WORKING TEMP	-30°C~55°C (-22°F~131°F)
DIMENSIONS	LxWxH (6.89"x1.73"x1.18")

* RGB-CT500-RX (Sold Separately)

RGB-CT700

MASTER RGBW WIFI CONTROLLER

INPUT VOLTAGE	12-24V DC
OUTPUT TYPE	Constant Voltage
POWER CAPACITY	288W (12V) 384W (24V)
OUTPUT CURRENT	5A per Channel (20A Total)
WORKING TEMP	-4°F (-20°C) ~ 122°F (50°C)
DIMENSIONS	LxWxH (7 x1.8 x 0.8")

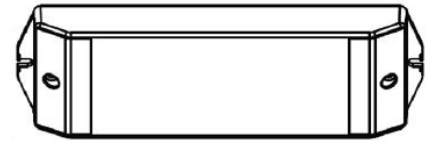

* Paired with RGB-CT705ZR (Sold Separately)

RGB-CT705ZR

SLAVE RGBW WIFI CONTROLLER

INPUT VOLTAGE	12-24V DC
OUTPUT TYPE	Constant Voltage
POWER CAPACITY	288W (12V) 384W (24V)
OUTPUT CURRENT	5A per Channel (20A Total)
WORKING TEMP	-4°F (-20°C) ~ 122°F (50°C)
DIMENSIONS	LxWxH (7 x0,63 x 0.71")

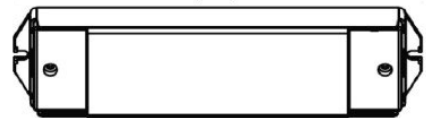

* Paired with RGB-CT700 (Sold Separately)

CSL-135

INDOOR SUSPENDED LED LUMINAIRE

NON-DMX CONTROLLERS (CONTINUED)

RGB-CT840

BLUETOOTH TOUCH PANEL WALL CONTROLLER

INPUT VOLTAGE	12-24V DC
ZONES	4
CONTROL MODE	RGB RGBW
WIRELESS PROTOCOL	Bluetooth 5.0 SIG Mesh
WORKING TEMP	-20°C ~ 55°C
DIMENSIONS	LxWxH (4.7"x3"x1.2")

** Paired with RGB-CT800-RC (Sold Separately)*



RGB-CT800-RC

BLUETOOTH CONSTANT VOLTAGE LED RECEIVER

INPUT VOLTAGE	12V 24V
OUTPUT CURRENT	4Ax5CH / 5Ax4CH (20A Max)
POWER CAPACITY	240W (12V) 480W (24V)
PROGRAMMABILITY	iOS and Android
WORKING TEMP	-20°C ~ 55°C
DIMENSIONS	LxWxH (6.9 x1.7 x 1.2")

** Paired with RGB-CT840 (Sold Separately)*



CSL-135

INDOOR SUSPENDED LED LUMINAIRE

COMPATIBLE TRANSFORMERS

PSDL SERIES TRIAC DIMMABLE

PSDL-30W-24V	CLASS 2	6.5" X 3.63" X 1.03"
PSDL-60W-24V	CLASS 2	7.4" X 3.63" X 1.03"
PSDL-96W-24V	CLASS 2	8.67" X 3.67 X 1.62"
PSDL-150W-24V		8.67" X 3.67" X 1.62"
PSDL-192W-24V	CLASS 2	10.25" X 4.06" X 1.82"
PSDL-200W-24V		10.25" X 4.06" X 1.82"
PSDL-288W-24V	CLASS 2	10.25" X 4.06" X 1.82"
PSDL-300W-24V		10.25" X 4.06" X 1.82"

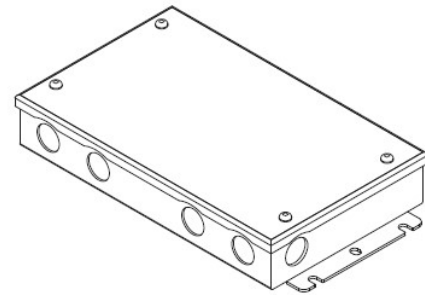

PSDH SERIES HIGH PERFORMANCE MAGNETIC LOW VOLTAGE (MLV)

PSDH-48W-24V	CLASS 2	11.25" X 3.37" X 3.25"
PSDH-96W-24V	CLASS 2	11.25" X 3.37" X 3.25"
PSDH-288W-24V	CLASS 2	14.25" X 8.43" X 4.43"

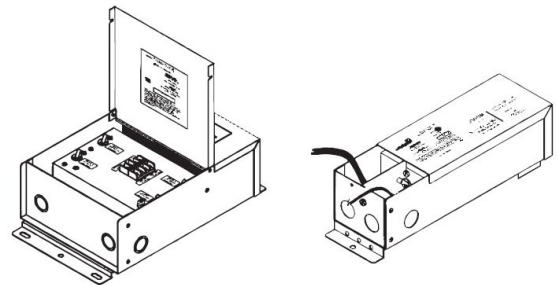

PSRX SERIES 4-IN-1 DIMMING DRIVER

PSRX-30W-24V	CLASS 2	6.5" X 3.72" X 1.57"
PSRX-60W-24V	CLASS 2	7.4" X 3.72" X 1.57"
PSRX-96W-24V	CLASS 2	8.66" X 3.72" X 1.57"
PSRX-150W-24V		10.24" X 4.13" X 1.77"
PSRX-192W-24V	CLASS 2	11" X 4" X 1.82"
PSRX-200W-24V		10.24" X 4.13" X 1.77"
PSRX-288W-24V	CLASS 2	11.85" X 4.25" X 1.82"
PSRX-300W-24V		10.94" X 4.33" X 1.77"

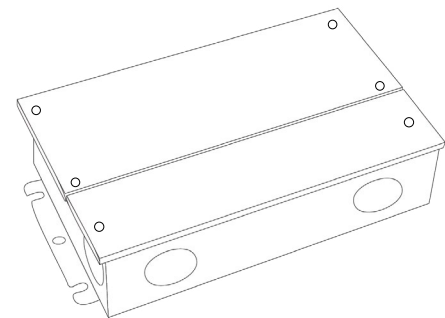

PSVT SERIES 0-10V DIMMING DRIVER

PSVT-60W-24V	CLASS 2	7.4" X 3.72" X 1.57"
PSVT-96W-24V	CLASS 2	8.66" X 3.72" X 1.57"
PSVT-200W-24V		10.24" X 4.13" X 1.77"
PSVT-288W-24V	CLASS 2	11.85" X 4.25" X 1.81"
PSVT-300W-24V		10.94" X 4.33" X 1.77"

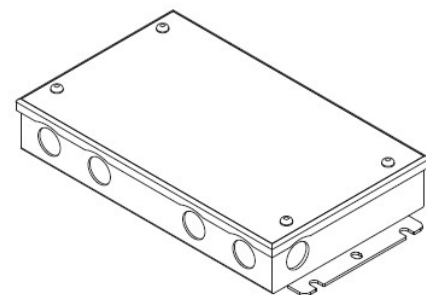

CSL-135

INDOOR SUSPENDED LED LUMINAIRE

COMPATIBLE TRANSFORMERS

PSDE SERIES 0-10V DIMMING W/ JUNCTION BOX

PSDE-60W-24V-010-JB	CLASS 2	12.1" X 2.36" X 1.4"
PSDE-96W-24V-010-JB	CLASS 2	12.1" X 2.36" X 1.4"

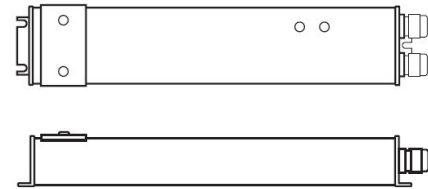

LUTRON 1% 3-WIRE DIMMING

L3DA4U1UKL-CV240	CLASS 2	4.89" X 4" X 2.62"
------------------	---------	--------------------

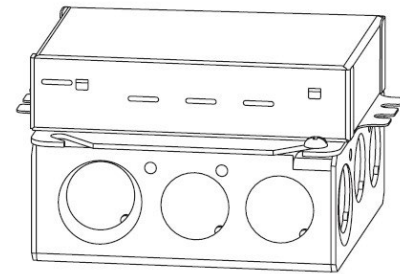

LUTRON 1%

PSDE-96W-24V-ECO	CLASS 2	10.5" X 3.0" X 2.0"
------------------	---------	---------------------

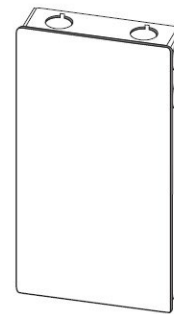

NON-DIMMING DRIVERS (COMPATABLE WITH ALL SYSTEMS)

PSHK SERIES NON-DIMMING CONSTANT VOLTAGE WITH JUNCTION BOX

PSHK-30W-24V	CLASS 2	6.5" X 3.6" X 1.02"
PSHK-60W-24V	CLASS 2	7.4" X 3.62" X 1.02"
PSHK-96W-24V	CLASS 2	8.66" X 3.66" X 1.61"
PSHK-150W-24V		10.24" X 4.06" X 1.81"
PSHK-200W-24V		10.24" X 4.06" X 1.81"
PSHK-288W-24V	CLASS 2	11.85" X 4.25" X 1.82"
PSHK-300W-24V		10.24" X 4.25" X 1.81"

