

INSTALLATION GUIDE

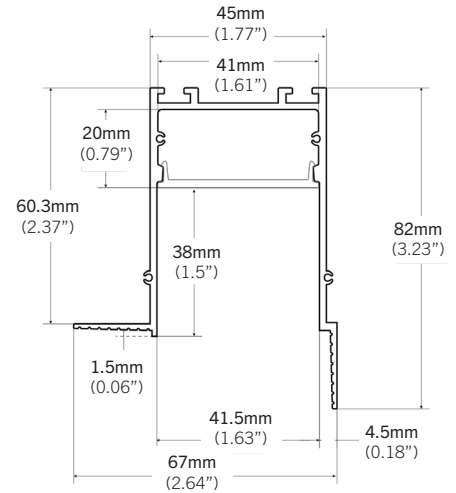

DIMENSIONS



PRE-INSTALLATION

Recessed/ Corner Mount

Disconnect power source prior to installation.

SAFETY

Read all instructions before installation.

These products may represent a possible shock or fire hazard if improperly installed.

Do not look directly into light.

This fixture is only suitable for indoor installation.



Product should be installed by a qualified electrician.



Product should be installed in accordance with these instructions and current electrical codes.

INSTALLATION

STEP 1

Measure cutout and mark drywall where channel will be mounted.

Cut channel to desired length.

STEP 2

Drill a hole in ALP-3400TL profile to accommodate the power feed cable. (Figure 1)

STEP 3

Peel the adhesive backing of the LED strip and install onto the channel. Carefully lead the power feed cable out of the previously drilled hole in the profile. (Figure 2)

**Make sure that the LED strip is laid evenly flat on the channel. This will avoid having any dark spots once lit up.*

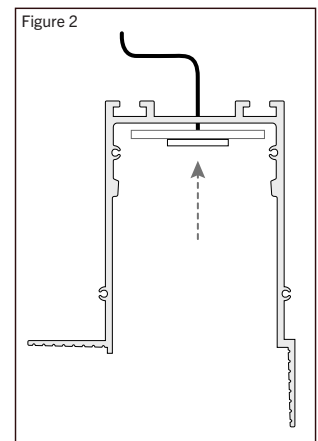
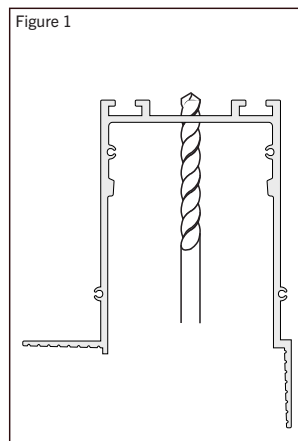

INSTALLATION (CONT.)

STEP 3

Use ALP2000TL-STB or ALP2000TL-INB to connect multiple channels if applicable. (Figure 3)

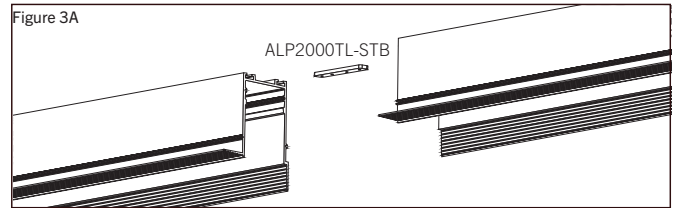

STEP 4

Push diffuser cover in place and secure end caps with screws. (Figure 4)

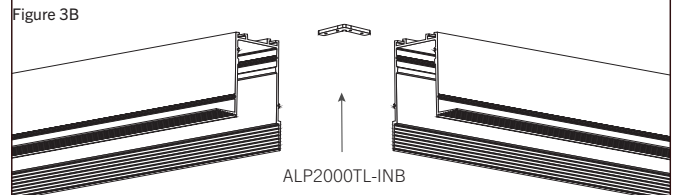

STEP 5

Mount/ Install ALP-3400TL profile onto drywall and secure in place with appropriate screws. (Figure 5)

** Make sure to use screws designed for metal.*

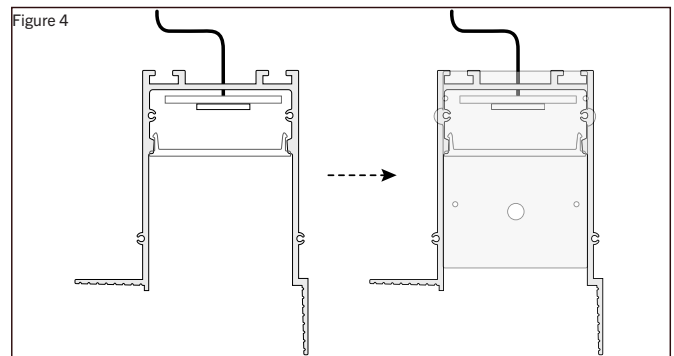

STEP 6

Before applying plaster to the edges, use drywall tape along the edges to avoid the plaster from cracking after installation.

Apply plaster to the flanges and wall to create an even surface. Once dry, finish with sand and paint. (Figure 6)

** Make sure that the drywall tapes do not overlap.*

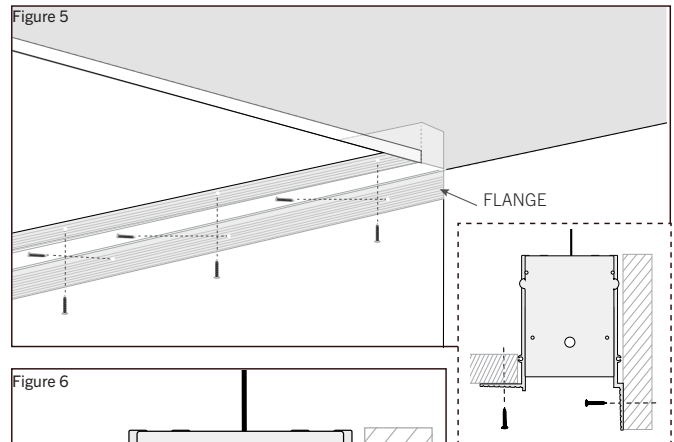

STEP 7

Using a sharp-edge tool, gently remove excess material (plaster and paint) in between the profile and the lens.

STEP 8

Wire as needed.

