

**INSTALLATION GUIDE**

**DIMENSIONS**

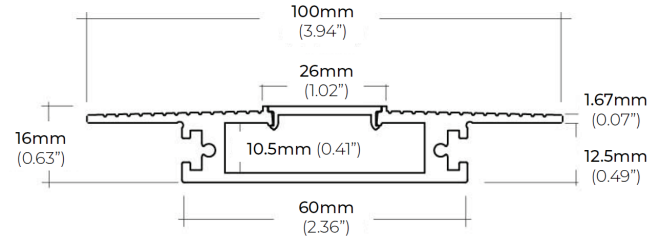

**PRE-INSTALLATION**

**Trimless Mount**

Disconnect power source prior to installation.

**SAFETY**

Read all instructions before installation.

These products may represent a possible shock or fire hazard if improperly installed.

Do not look directly into light.

This fixture is only suitable for indoor installation.



Product should be installed by a qualified electrician.



Product should be installed in accordance with these instructions and current electrical codes.

**INSTALLATION**

**STEP 1** Measure and mark the drywall where the channel will be mounted. (Figure 1)

**STEP 2** Cut channel to desired length. (Figure 2)

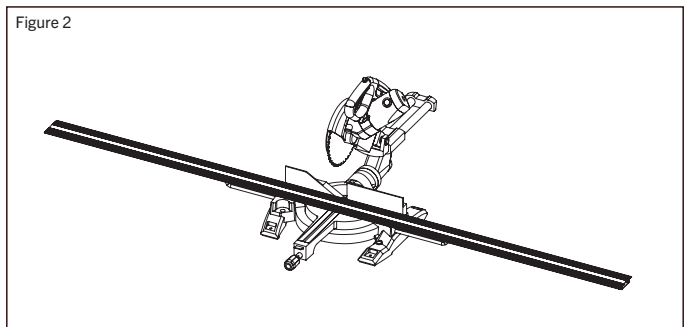
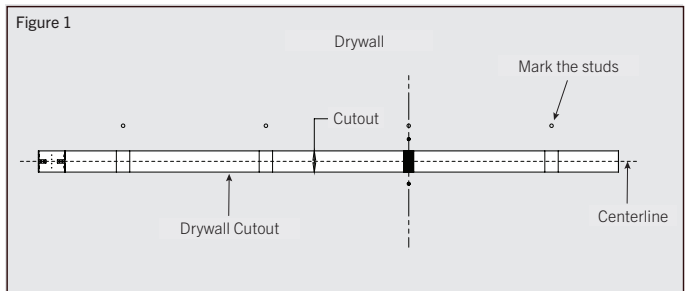

**INSTALLATION (CONT.)**

STEP 3

Use ALP2000TL-STB, ALP2000TL-INB, or ALP2000TL-L90 to connect multiple channels if applicable. (Figure 3)

STEP 4

Attach the end caps. (Figure 4)

STEP 5

Mount/ Install ALP-2100TL profile into the drywall. Drill and countersink channel with screws. (Figure 5)

\* Make sure all screw heads are flush with the channel surface.

\*To prevent damage to the channel, factory recommends only drilling into the flange. **DO NOT** drill into the center of the channel.

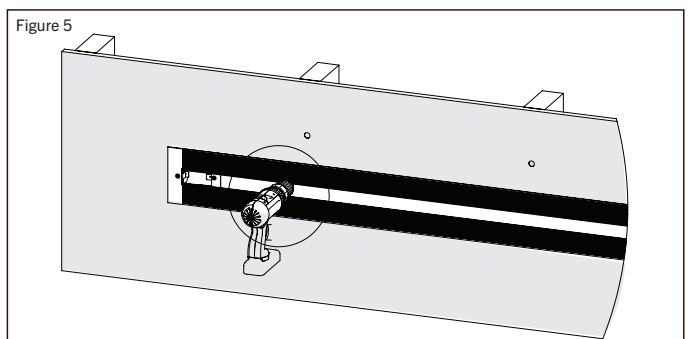
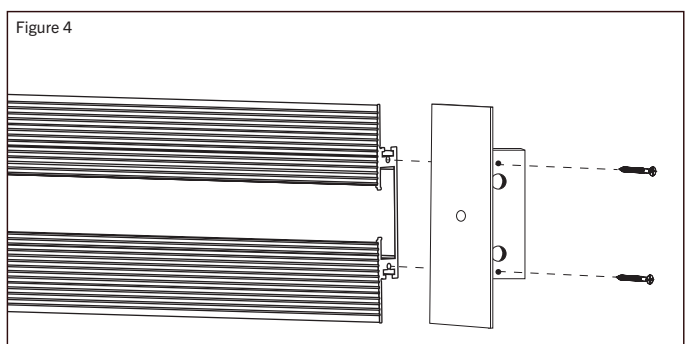
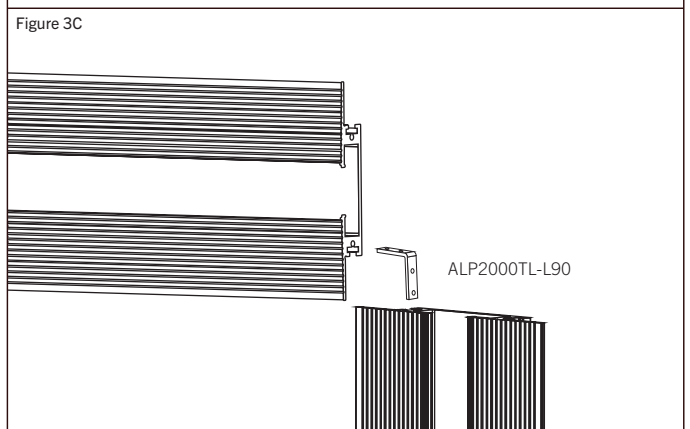
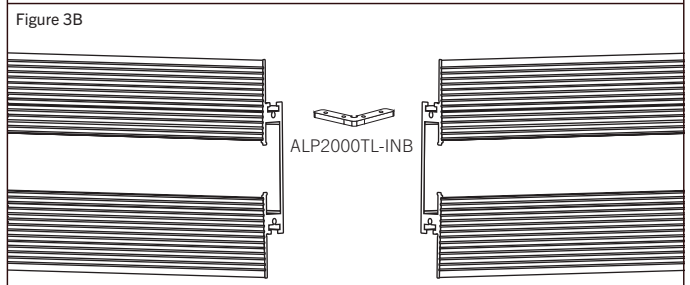
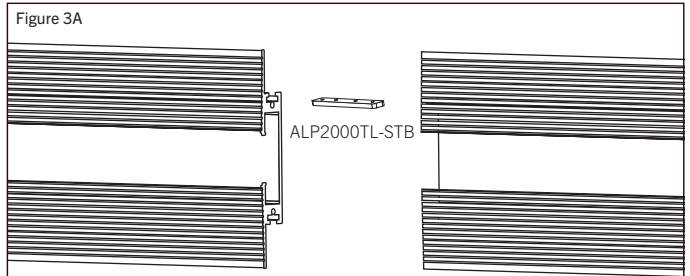

**INSTALLATION (CONT.)**

**STEP 6**

Before applying plaster to the edges, use drywall tape along the edges to avoid the plaster from cracking after installation. (Figure 6)

Apply plaster to the edges and finish with sand and paint.

\* Make sure that the drywall tapes do not overlap.

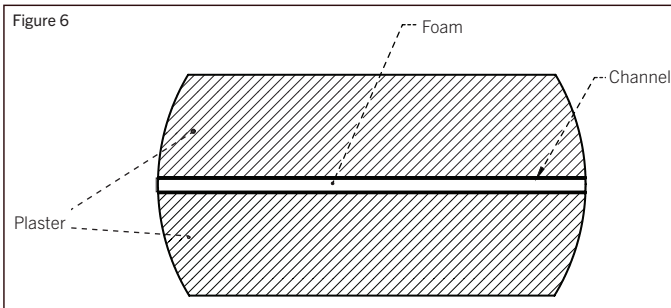

**STEP 7**

Peel the adhesive backing of the LED strips and install onto the channel on the parts illustrated in the illustration. (Figure 7A)

Make sure that the LED strips are laid evenly flat on the channel. This will avoid having any dark spots once lit up. (Figure 7B)

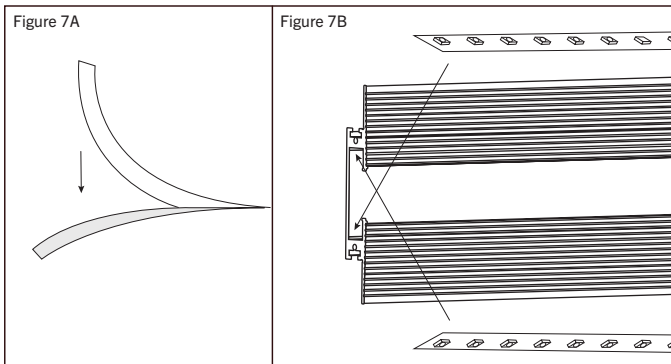

**STEP 8**

Push the diffuser cover in place. (Figure 8)

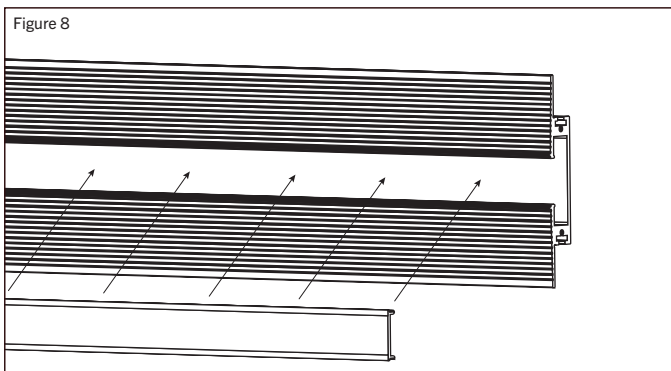

**STEP 9**

Wire as needed.