

PSDL-200W-12V-UNV

DIMMABLE DRIVER W/ JUNCTION BOX

Project _____
Location _____
Quote/ Ref # _____

The **PSDL SERIES** indoor/outdoor drivers are highly efficient, stable with smooth dimming capability compatible with most TRIAC, ELV, MLV, reverse and forward phase dimmers, and on/off switches. These drivers are derated allowing them to be loaded to maximum wattage capacity.



SPECIFICATIONS

CLASS 2	No
LOAD REGULATION	2%
LINE REGULATION	5%
INPUT FREQUENCY	47-63 Hz
POWER FACTOR	> 0.92
EFFICIENCY	> 83%
MTBF	50,000 Hrs.
DIMMING	ELV, MLV, and TRIAC
SHORT CIRCUIT	Short Circuit Auto Recovery
WIRE TERMINAL CONNECT	Fits up to 12AWG
HOUSING/ COOLING	Free-air convection
ENVIRONMENT	Outdoor Rated IP65
OPERATING TEMPERATURE	-40°F (-40°C) ~ 140°F (60°C)
FUNCTION SURFACE TEMP	-40 to 80 (25 C AMB)
STORAGE TEMPERATURE	-40°F (-40°C) ~ 176°F (80°C)
HUMIDITY	20-90% RH, non condensing
CERTIFICATIONS	UL Listed (US and Canada)
SAFETY STANDARDS	UL 8750, UL 1310
WITHSTAND VOLTAGE	I/P-O/P : 1.88KV AC
EMC EMISSION	FCC Part 15 B
DIMENSIONS	260.3 x 103.2 x 41.1mm (10.25 x 4.06 x 1.82") (LxWxH)

FEATURES

- High power factor/ efficiency
- Short circuit and over current protection
- 100-277V AC for any residential or commercial application
- Superior PWM dimming technology
- Factory derated
- Only 10% minimum load
- Compatible with TRIAC, MLV, and ELV dimmers
- Flicker-free dimming

DIMENSIONS

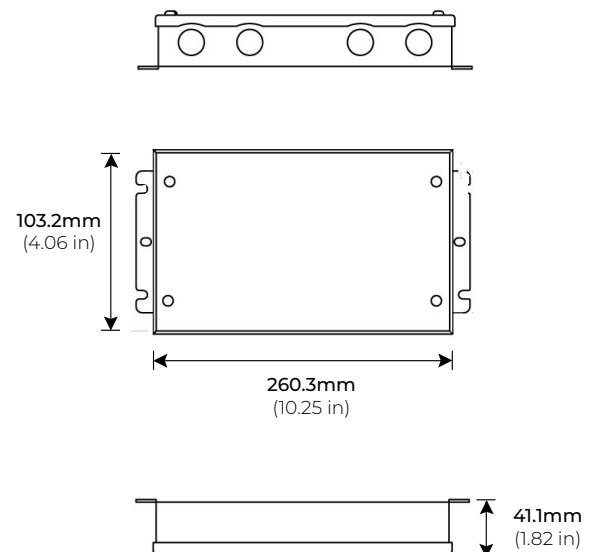

INPUT

INPUT VOLTAGE RANGE	100-277V AC
INPUT FREQUENCY RANGE	47 - 63 Hz
POWER FACTOR (AVG.)	≥ 0.98 (120VAC) ; ≥ 0.95 (277VAC)
AC CURRENT (MAX.)	2.3A (100V AC)
INRUSH CURRENT	15A, 50%, 1.4ms
LEAKAGE CURRENT	< 0.5mA

OUTPUT

OUTPUT VOLTAGE	12V DC
OUTPUT CURRENT (MAX.)	16.6A
OUTPUT WATTAGE (MAX.)	200W
MINIMUM LOAD	10%
MAXIMUM LOAD	100%



PSDL-200W-12V-UNV

DIMMABLE DRIVER W/ JUNCTION BOX

WIRING DIAGRAM

