

# SLINQ RIGID

## 360° ROUND NEON SERIES

Project \_\_\_\_\_

Location \_\_\_\_\_

Quote/ Ref # \_\_\_\_\_

**Slinq Rigid**— IP65 rated, semi-rigid LED light is the perfect solution for those looking to create stunning 360° illuminating designs that stay in place. Whether you're looking to add some ambiance to your living space or create an eye-catching centerpiece, the Slinq Rigid is the perfect solution. Unleash your creativity to create any desired shape, freeform pattern, grid, icicle chandeliers, or simply drape it along walls and ceilings.

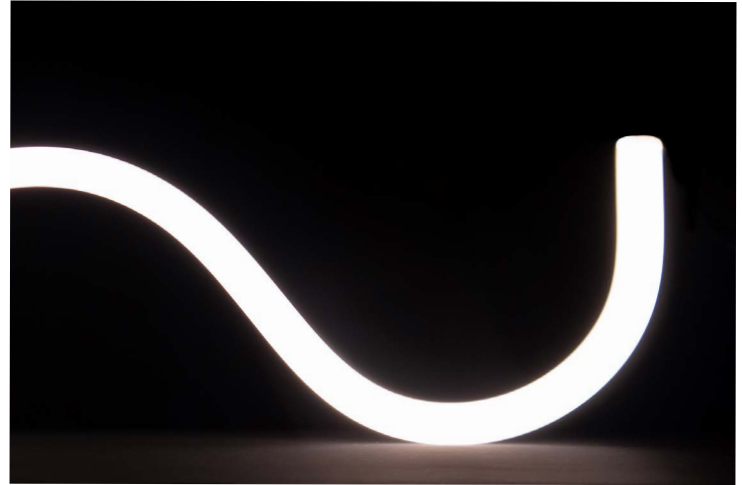

### SPECIFICATIONS

POWER CONSUMPTION	6.08W per Ft.
LUMEN OUTPUT	359 Lumens per Ft. (30K)
CRI	90+
COLOR TEMPERATURE	24K/ 27K/ 30K/ 40K
MAXIMUM RUN LENGTH	16 Ft.
OPERATING VOLTAGE	24V
STORAGE TEMPERATURE	0°C (0°F) to 60°C (140°F)
OPERATING TEMPERATURE	-25°C (-13°F) to 55°C (131°F)
BEAM ANGLE	360°
IP RATING	IP65 Outdoor/ Wet Location
LUMEN MAINTENANCE	50,000 Hrs.

### FEATURES

- 360° Light Source
- Universal Dimming
- 24V
- IP65 Outdoor Rated
- Factory-Installed Power Feed
- Injection Moulded End-Caps
- Ideal for Office, Decorative, Artistic Lighting



MODEL	LENGTH	COLOR TEMP	VOLTAGE	MOUNTING OPTIONS	POWER FEED
SLQ25-RG	Per Inch Per Inch	<b>24K</b> 2400K	<b>24V</b> 24 Volts	<b>AR</b> Arch	<b>EF72</b> 72" End Feed
		<b>27K</b> 2700K		<b>SF</b> Surface Pendant	<b>SF72</b> 72" Side Feed
		<b>30K</b> 3000K		<b>SUP</b> Suspended Pendant	
		<b>40K</b> 4000K		<b>SCS</b> Suspension Cable Support	
				<b>TES</b> Telescopic Extension Support	

# SLINQ RIGID

## 360° ROUND NEON SERIES

### MOUNTING OPTIONS

#### ARCH (AR)

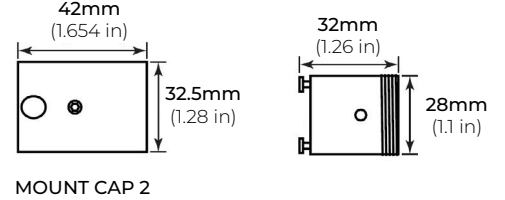
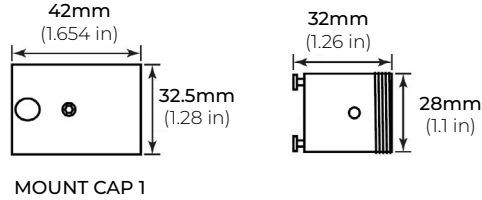
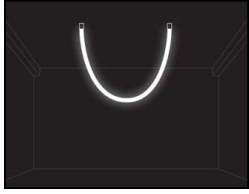

#### SURFACE PENDANT (SF)

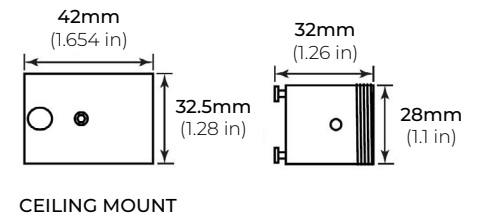
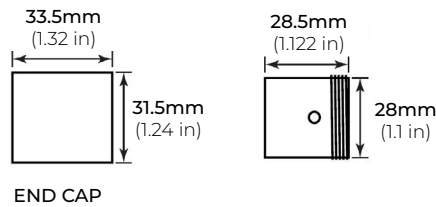
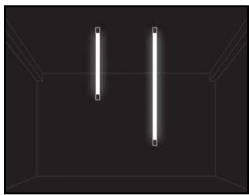

#### SUSPENDED PENDANT (SUP)

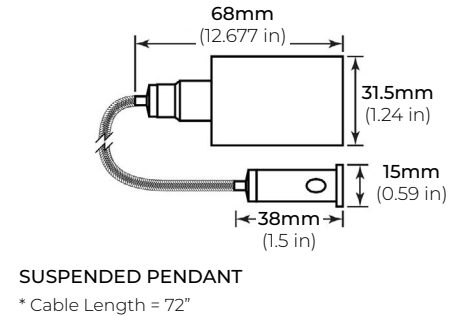
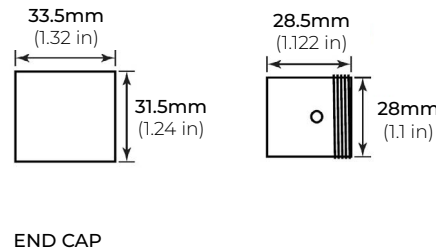
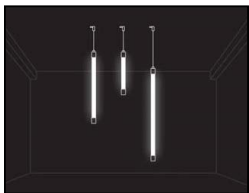

#### SUSPENSION CABLE SUPPORT (SCS)

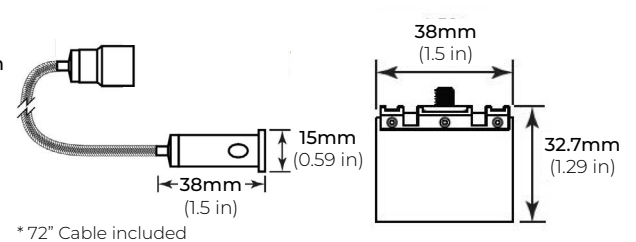
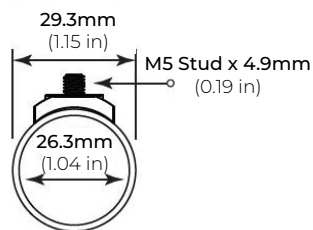
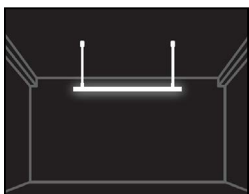

#### TELESCOPIC EXTENSION SUPPORT (TES)

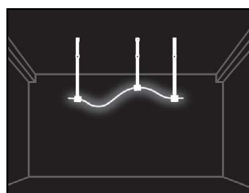

\* 13 - 24" Extension

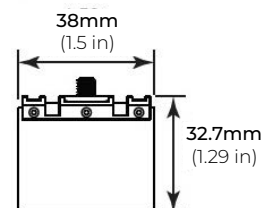
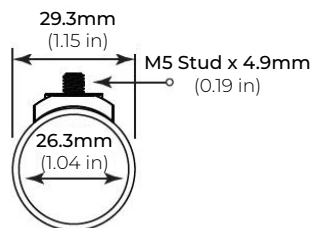

# SLINQ RIGID

## 360° ROUND NEON SERIES

### ACCESSORIES

VISIBLE MOUNTING CLIP (VMC)

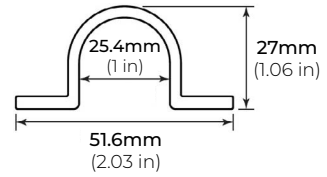

DISCREET MOUNTING BRACKET (DMB)

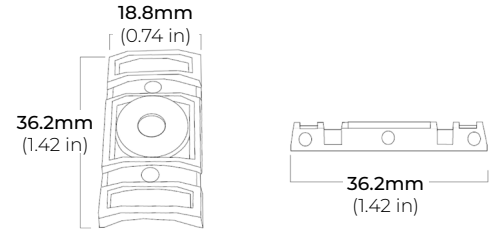

INFINITY JOINER (IJ)

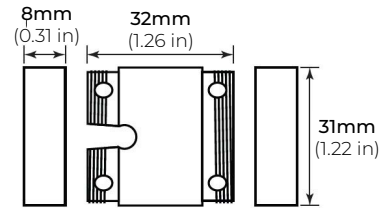
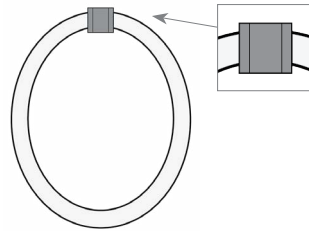

### DIMENSIONS

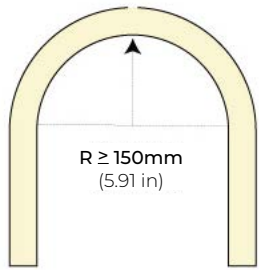

Minimum Bend Radius

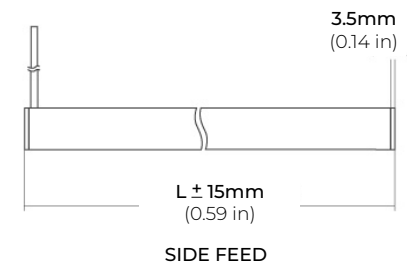
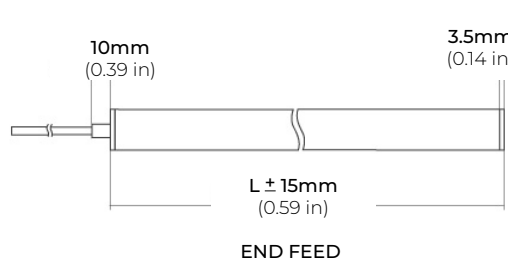

# SLINQ RIGID

## 360° ROUND NEON SERIES

### COMPATIBLE TRANSFORMERS

---

#### PSDL SERIES TRIAC DIMMABLE

PSDL-30W-24V	CLASS 2	6.5" X 3.63" X 1.03"
PSDL-60W-24V	CLASS 2	7.4" X 3.63" X 1.03"
PSDL-96W-24V	CLASS 2	8.67" X 3.67 X 1.62"
PSDL-150W-24V		8.67" X 3.67" X 1.62"
PSDL-192W-24V	CLASS 2	10.25" X 4.06" X 1.82"
PSDL-200W-24V		10.25" X 4.06" X 1.82"
PSDL-288W-24V	CLASS 2	10.25" X 4.06" X 1.82"
PSDL-300W-24V		10.25" X 4.06" X 1.82"

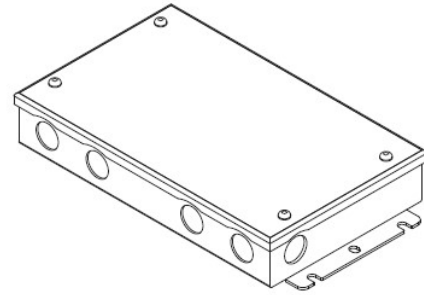

#### PSDH SERIES HIGH PERFORMANCE MAGNETIC LOW VOLTAGE (MLV)

PSDH-48W-24V	CLASS 2	11.25" X 3.37" X 3.25"
PSDH-96W-24V	CLASS 2	11.25" X 3.37" X 3.25"
PSDH-288W-24V	CLASS 2	14.25" X 8.43" X 4.43"

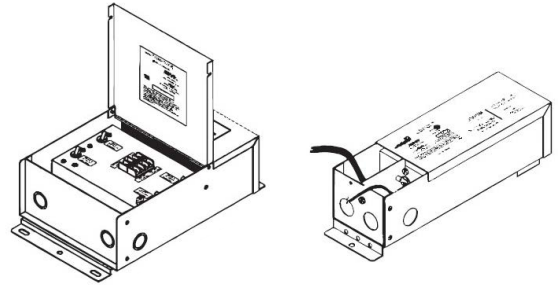

#### PSRX SERIES 4-IN-1 DIMMING DRIVER

PSRX-30W-24V	CLASS 2	6.5" X 3.72" X 1.57"
PSRX-60W-24V	CLASS 2	7.4" X 3.72" X 1.57"
PSRX-96W-24V	CLASS 2	8.66" X 3.72" X 1.57"
PSRX-150W-24V		10.24" X 4.13" X 1.77"
PSRX-192W-24V	CLASS 2	11" X 4" X 1.82"
PSRX-200W-24V		10.24" X 4.13" X 1.77"
PSRX-288W-24V	CLASS 2	11.85" X 4.25" X 1.82"
PSRX-300W-24V		10.94" X 4.33" X 1.77"

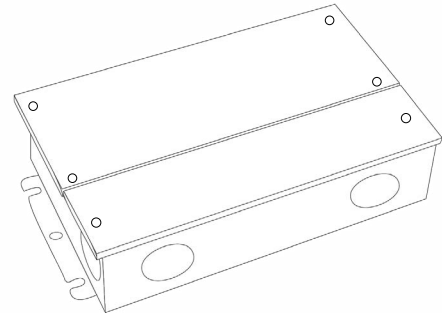

#### PSVT SERIES 4-IN-1 DIMMING DRIVER

PSVT-60W-24V	CLASS 2	7.4" X 3.72" X 1.57"
PSVT-96W-24V	CLASS 2	8.66" X 3.72" X 1.57"
PSVT-200W-24V		10.24" X 4.13" X 1.77"
PSVT-288W-24V	CLASS 2	11.85" X 4.25" X 1.81"
PSVT-300W-24V		10.94" X 4.33" X 1.77"

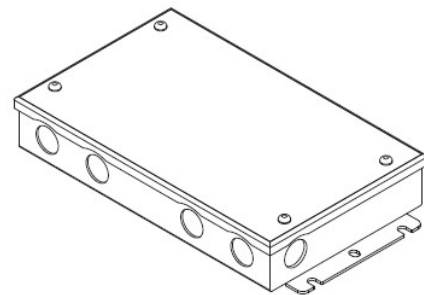

# SLINQ RIGID

## 360° ROUND NEON SERIES

### COMPATIBLE TRANSFORMERS

#### PSDE SERIES

0-10V DIMMING W/ JUNCTION BOX

PSDE-60W-24V-010-JB	CLASS 2	12.1" X 2.36" X 1.4"
PSDE-96W-24-010-JB	CLASS 2	12.1" X 2.36" X 1.4"

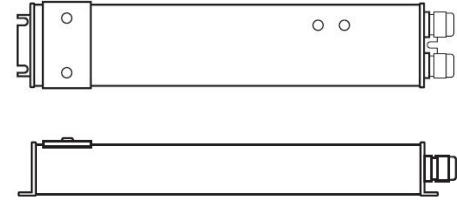

#### LUTRON 1%

3-WIRE DIMMING

L3DA4U1UJKL-CV240	CLASS 2	4.89" X 4" X 2.62"
-------------------	---------	--------------------

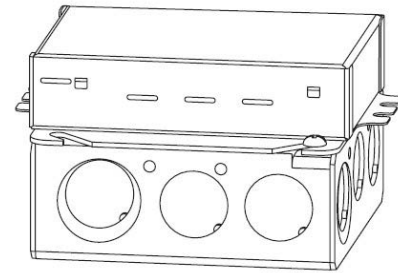

PSDE-96W-24V-ECO	CLASS 2	10.5" X 3.0" X 2.0"
------------------	---------	---------------------

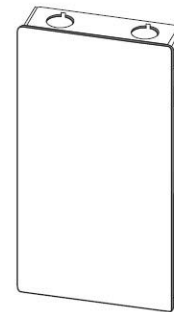

### COMPATIBLE NON-DIMMING DRIVERS

#### PSHK SERIES

NON-DIMMING CONSTANT VOLTAGE WITH JUNCTION BOX

PSHK-30W-24V	CLASS 2	6.5" X 3.6" X 1.02"
PSHK-60W-24V	CLASS 2	7.4" X 3.62" X 1.02"
PSHK-96W-24V	CLASS 2	8.66" X 3.66" X 1.61"
PSHK-150W-24V		10.24" X 4.06" X 1.81"
PSHK-200W-24V		10.24" X 4.06" X 1.81"
PSHK-288W-24V	CLASS 2	11.85" X 4.25" X 1.82"
PSHK-300W-24V		10.24" X 4.25" X 1.81"

