

LSXT-450

4.4W LONG RUN OUTDOOR FLEXIBLE LED STRIP

Project _____
Location _____
Quote/ Ref # _____

The **LSXT-450** series is a dimmable, flexible LED strip capable of delivering up to 473 Lumens of light output per foot. It is cuttable every 3.94" and can reach a maximum of 32 Ft. in a single, continuous run. This innovative strip delivers consistent brightness with superior color rendering at a very efficient package.

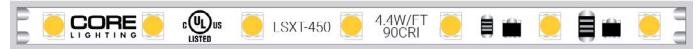

SPECIFICATIONS

INPUT VOLTAGE	24V DC
POWER CONSUMPTION	4.4W/Ft.
NO. OF LEDS	21 LEDs per Ft.
LUMEN OUTPUT	473 Lumens per foot (30K)
CRI	95+
COLOR TEMPERATURE	40K
DIMMING	MLV, ELV, 0-10V and TRIAC
MAXIMUM RUN LENGTH	32 Ft.
CUTTABLE	Every 3.89 in (98.93mm)
OPERATING TEMPERATURE	-40°F (-40°C) ~ +140°F (+60°C)
STORAGE TEMPERATURE	-22°F(-30°C)~+176°F(+80°C)
BEAM ANGLE	120°
IP RATING	IP65 wet location (outdoor)
CERTIFICATIONS	UL Listed, TITLE 24 JA8
LUMEN MAINTENANCE	50,000 Hrs

FEATURES

- 4.4W/Ft.
- 24V Low-Voltage LED Strip
- Suitable for accent or ambient lighting
- Multiple CCT options available
- Superior COLOR RENDERING INDEX (CRI)
- Dimmable with CORE Lighting Dimming Drivers
- UL Listed

*Approved for closet / storage space installation per NEC 410.16(A)(3) and 410.16(C)(5)



MODEL	COLOR TEMP	LENGTH	VOLTAGE
LSXT450	27K 2700K	100 100 Ft.	24 24V DC
	30K 3000K	325 325 Ft.	
	40K 4000K	∞X Per Ft.	

LSXT-450

4.4W LONG RUN OUTDOOR FLEXIBLE LED STRIP

DIMENSIONS

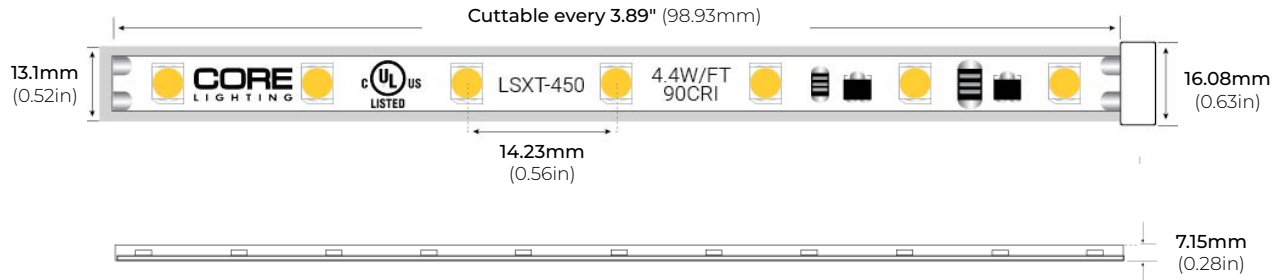

COMPATIBLE ACCESSORIES

LSXT-EC
END CAP

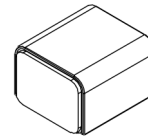

ALU-CN (CORNER)

LENGTHS 39" | 78" | 84" | 96"
LENS Clear, Frosted
FINISH Black | Silver

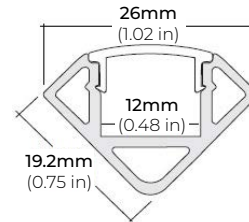

ALUMINUM CHANNEL

LSXT-AC2
LSXT-AC48
2" ALUMINUM CHANNEL
48" ALUMINUM CHANNEL

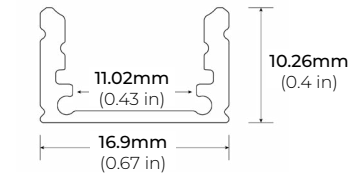

EXTENSION COUPLING

LSXT-EX3 3" LINK CABLE
LSXT-EX8 8" LINK CABLE
LSXT-EX24 24" LINK CABLE

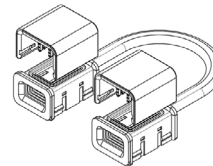

HARDWIRE CONNECTOR

LSXT-HW24 24" HARDWIRE CONNECTOR
LSXT-HW60 60" HARDWIRE CONNECTOR
LSXT-HW120 120" HARDWIRE CONNECTOR

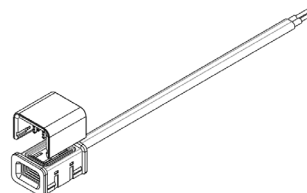

LSXT-450

4.4W LONG RUN OUTDOOR FLEXIBLE LED STRIP

COMPATIBLE TRANSFORMERS

PSDL SERIES TRIAC DIMMABLE

PSDL-30W-24V	CLASS 2	6.5" X 3.63" X 1.03"
PSDL-60W-24V	CLASS 2	7.4" X 3.63" X 1.03"
PSDL-96W-24V	CLASS 2	8.67" X 3.67 X 1.62"
PSDL-150W-24V		8.67" X 3.67" X 1.62"
PSDL-192W-24V	CLASS 2	10.25" X 4.06" X 1.82"
PSDL-200W-24V		10.25" X 4.06" X 1.82"
PSDL-288W-24V	CLASS 2	10.25" X 4.06" X 1.82"
PSDL-300W-24V		10.25" X 4.06" X 1.82"

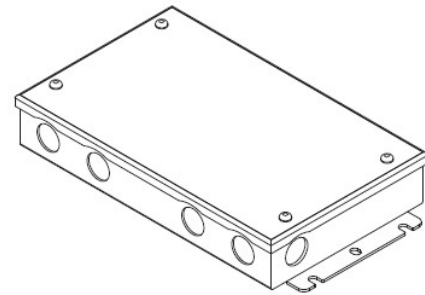

PSDH SERIES HIGH PERFORMANCE MAGNETIC LOW VOLTAGE (MLV)

PSDH-48W-24V	CLASS 2	11.25" X 3.37" X 3.25"
PSDH-96W-24V	CLASS 2	11.25" X 3.37" X 3.25"
PSDH-288W-24V	CLASS 2	14.25" X 8.43" X 4.43"

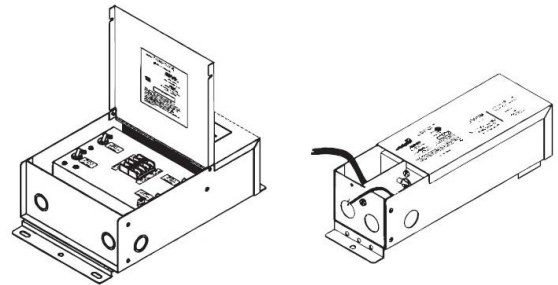

PSRX SERIES 4-IN-1 DIMMING DRIVER

PSRX-30W-24V	CLASS 2	6.5" X 3.72" X 1.57"
PSRX-60W-24V	CLASS 2	7.4" X 3.72" X 1.57"
PSRX-96W-24V	CLASS 2	8.66" X 3.72" X 1.57"
PSRX-150W-24V		10.24" X 4.13" X 1.77"
PSRX-192W-24V	CLASS 2	11" X 4" X 1.82"
PSRX-200W-24V		10.24" X 4.13" X 1.77"
PSRX-288W-24V	CLASS 2	11.85" X 4.25" X 1.82"
PSRX-300W-24V		10.94" X 4.33" X 1.77"

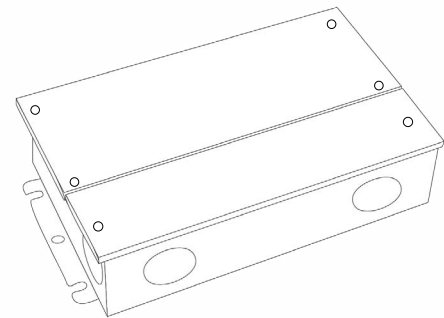

PSVT SERIES 0-10V DIMMING DRIVER

PSVT-60W-24V	CLASS 2	7.4" X 3.72" X 1.57"
PSVT-96W-24V	CLASS 2	8.66" X 3.72" X 1.57"
PSVT-200W-24V		10.24" X 4.13" X 1.77"
PSVT-288W-24V	CLASS 2	11.85" X 4.25" X 1.81"
PSVT-300W-24V		10.94" X 4.33" X 1.77"

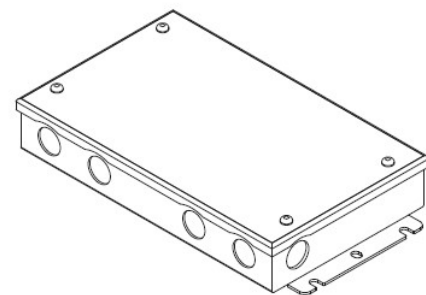

LSXT-450

4.4W LONG RUN OUTDOOR FLEXIBLE LED STRIP

COMPATIBLE TRANSFORMERS

PSDE SERIES
0-10V DIMMING W/ JUNCTION BOX

PSDE-60W-24V-010-JB CLASS 2 12.1" X 2.36" X 1.4"
PSDE-96W-24V-010-JB CLASS 2 12.1" X 2.36" X 1.4"

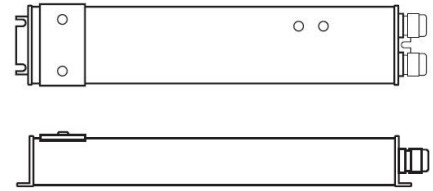

LUTRON 1%
3-WIRE DIMMING

L3DA4U1UKL-CV240 CLASS 2 4.89" X 4" X 2.62"

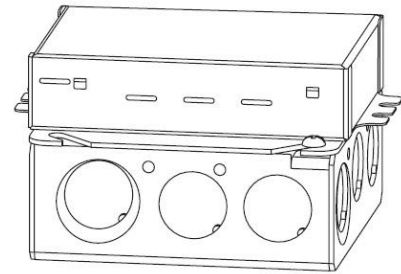

PSDE-96W-24V-ECO CLASS 2 10.5" X 3.0" X 2.0"

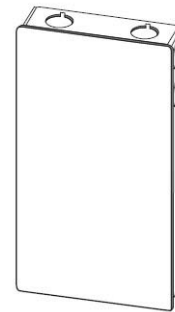

COMPATIBLE NON-DIMMING DRIVERS

PSHK SERIES
NON-DIMMING CONSTANT VOLTAGE WITH JUNCTION BOX

PSHK-30W-24V CLASS 2 6.5" X 3.6" X 1.02"
PSHK-60W-24V CLASS 2 7.4" X 3.62" X 1.02"
PSHK-96W-24V CLASS 2 8.66" X 3.66" X 1.61"
PSHK-150W-24V 10.24" X 4.06" X 1.81"
PSHK-200W-24V 10.24" X 4.06" X 1.81"
PSHK-288W-24V CLASS 2 11.85" X 4.25" X 1.82"
PSHK-300W-24V 10.24" X 4.25" X 1.81"

