

LSRE-40

4.4W IP67 FLEXIBLE LED NEON SERIES

Project _____
Location _____
Quote/ Ref # _____

The **LSRE-40** is a high performance flexible and affordable LED fixture designed as a neon replacement and is also useful in a wide variety of indoor or outdoor applications where a smooth surface or continuous line of light is desired. It is a flexible strip light that can bend around contours or tight curves vertically without being damaged.



SPECIFICATIONS

| | |
|-----------------------|-------------------------------|
| POWER CONSUMPTION | 4.4W per Ft. |
| LUMEN OUTPUT | 178 Lumens per Ft. |
| CRI | 95+ |
| COLOR TEMPERATURE | 27K/ 30K/ 35K/ 40K |
| DIMMING/ CONTROL | MLV, ELV, 0-10 and TRIAC |
| MAXIMUM RUN LENGTH | 24 Ft. |
| CUTTABLE | Every 3.94 in. (100mm) |
| OPERATING VOLTAGE | 24V DC |
| STORAGE TEMPERATURE | -40°F (-40°C) to 176°F (80°C) |
| OPERATING TEMPERATURE | -4°F (-20°C) to 113°F (45°C) |
| BEAM ANGLE | 110° |
| IP RATING | IP67 |
| CERTIFICATIONS | UL Listed, CE, RoHS |
| LUMEN MAINTENANCE | 50,000 Hrs. |

FEATURES

- High color consistency and smooth illumination
- Multiple CCT options available
- Continuous run length up to 24 Ft.
- Cuttable every 3.94 in. (100mm)
- Bottom, Side and End Feed options
- UL Listed, CE and RoHS



| MODEL | LIGHT SURFACE | COLOR TEMP | VOLTAGE | LENGTH | POWER FEED | FEED LENGTH |
|---------|---------------------|---------------------|---------------------|-----------------|-----------------------------------|----------------------------------|
| LSRE-40 | VB Vertical Bend | 27K 2700K | 24 24V DC | 1'XX per Ft. | IP67BF Bottom Feed | HW3 3 Ft. Power Feed |
| | | 30K 3000K | | | IP67SFL Side Feed Left | HW10 10 Ft. Power Feed |
| | | 35K 3500K | | | IP67SFR Side Feed Right | HW15 15 Ft. Power Feed |
| | | 40K 4000K | | | IP67EF End Feed | HW30 30 Ft. Power Feed |
| | | | | | | HW50 50 Ft. Power Feed |

*1 = Custom length per FT. (cuttable every 3.94")

LSRE-40

4.4W IP67 FLEXIBLE LED NEON SERIES

DIMENSIONS

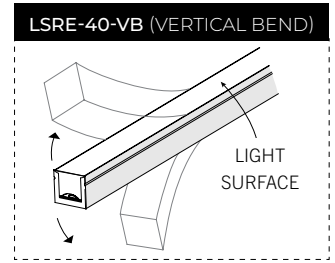
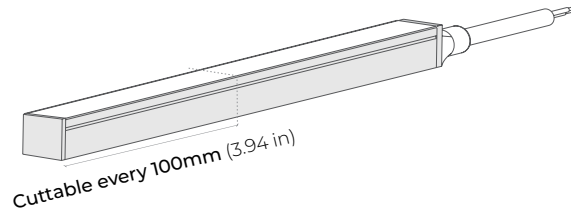
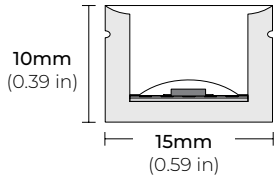

COMPATIBLE ACCESSORIES

MOUNTING ALUMINUM PROFILE

LSRE-40-AC2
2" PROFILE

LSRE-40-AC39
39" PROFILE

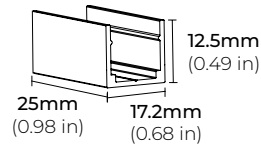

LSRE-40-AC2

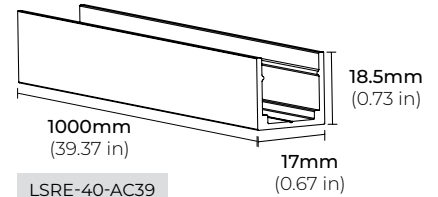

LSRE-40-AC39

IP67 POWER FEED

IP67BF
BOTTOM FEED

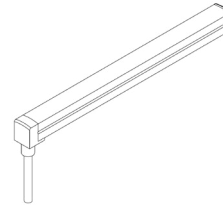

IP67FL
SIDE LEFT FEED

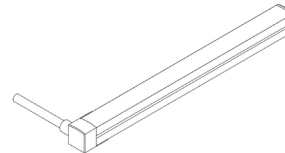

IP67FR
SIDE RIGHT FEED

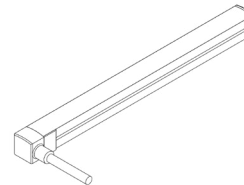

IP67EF
END FEED

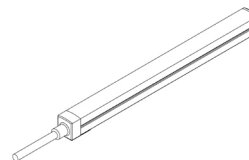

LSRE-40

4.4W IP67 FLEXIBLE LED NEON SERIES

COMPATIBLE TRANSFORMERS

PSDL SERIES TRIAC DIMMABLE

| | | |
|---------------|---------|------------------------|
| PSDL-30W-24V | CLASS 2 | 6.5" X 3.63" X 1.03" |
| PSDL-60W-24V | CLASS 2 | 7.4" X 3.63" X 1.03" |
| PSDL-96W-24V | CLASS 2 | 8.67" X 3.67" X 1.62" |
| PSDL-150W-24V | | 8.67" X 3.67" X 1.62" |
| PSDL-192W-24V | CLASS 2 | 10.25" X 4.06" X 1.82" |
| PSDL-200W-24V | | 10.25" X 4.06" X 1.82" |
| PSDL-288W-24V | CLASS 2 | 10.25" X 4.06" X 1.82" |
| PSDL-300W-24V | | 10.25" X 4.06" X 1.82" |

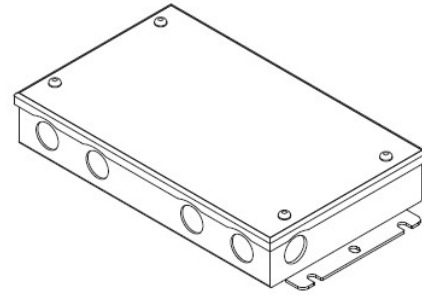

PSDH SERIES HIGH PERFORMANCE MAGNETIC LOW VOLTAGE (MLV)

| | | |
|---------------|---------|------------------------|
| PSDH-48W-24V | CLASS 2 | 11.25" X 3.37" X 3.25" |
| PSDH-96W-24V | CLASS 2 | 11.25" X 3.37" X 3.25" |
| PSDH-288W-24V | CLASS 2 | 14.25" X 8.43" X 4.43" |

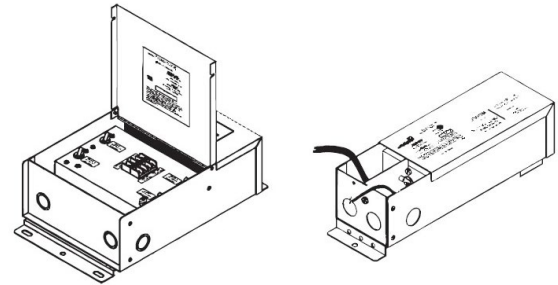

PSRX SERIES 4-IN-1 DIMMING DRIVER

| | | |
|---------------|---------|------------------------|
| PSRX-30W-24V | CLASS 2 | 6.5" X 3.72" X 1.57" |
| PSRX-60W-24V | CLASS 2 | 7.4" X 3.72" X 1.57" |
| PSRX-96W-24V | CLASS 2 | 8.66" X 3.72" X 1.57" |
| PSRX-150W-24V | | 10.24" X 4.13" X 1.77" |
| PSRX-192W-24V | CLASS 2 | 11" X 4" X 1.82" |
| PSRX-200W-24V | | 10.24" X 4.13" X 1.77" |
| PSRX-288W-24V | CLASS 2 | 11.85" X 4.25" X 1.82" |
| PSRX-300W-24V | | 10.94" X 4.33" X 1.77" |

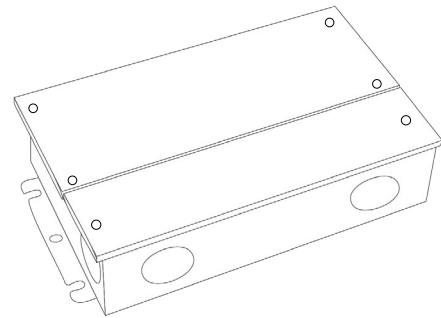

PSVT SERIES 0-10V DIMMING DRIVER

| | | |
|---------------|---------|------------------------|
| PSVT-60W-24V | CLASS 2 | 7.4" X 3.72" X 1.57" |
| PSVT-96W-24V | CLASS 2 | 8.66" X 3.72" X 1.57" |
| PSVT-200W-24V | | 10.24" X 4.13" X 1.77" |
| PSVT-288W-24V | CLASS 2 | 11.85" X 4.25" X 1.81" |
| PSVT-300W-24V | | 10.94" X 4.33" X 1.77" |

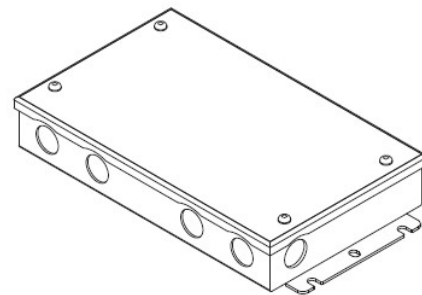

LSRE-40

4.4W IP67 FLEXIBLE LED NEON SERIES

COMPATIBLE TRANSFORMERS

PSDE SERIES

0-10V DIMMING W/ JUNCTION BOX

| | | |
|---------------------|---------|----------------------|
| PSDE-60W-24V-010-JB | CLASS 2 | 12.1" X 2.36" X 1.4" |
| PSDE-96W-24V-010-JB | CLASS 2 | 12.1" X 2.36" X 1.4" |

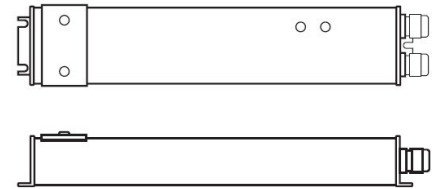

LUTRON 1% 3-WIRE DIMMING

| | | |
|------------------|---------|--------------------|
| L3DA4U1UKL-CV240 | CLASS 2 | 4.89" X 4" X 2.62" |
|------------------|---------|--------------------|

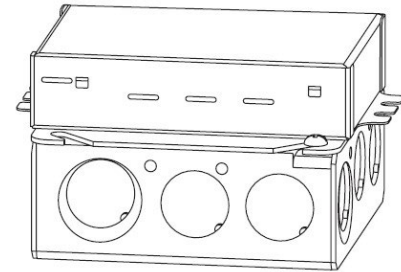

| | | |
|------------------|---------|---------------------|
| PSDE-96W-24V-ECO | CLASS 2 | 10.5" X 3.0" X 2.0" |
|------------------|---------|---------------------|

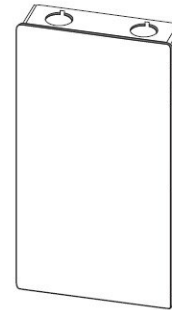

COMPATIBLE NON-DIMMING DRIVERS

PSHK SERIES

NON-DIMMING CONSTANT VOLTAGE WITH JUNCTION BOX

| | | |
|---------------|---------|------------------------|
| PSHK-30W-24V | CLASS 2 | 6.5" X 3.6" X 1.02" |
| PSHK-60W-24V | CLASS 2 | 7.4" X 3.62" X 1.02" |
| PSHK-96W-24V | CLASS 2 | 8.66" X 3.66" X 1.61" |
| PSHK-150W-24V | | 10.24" X 4.06" X 1.81" |
| PSHK-200W-24V | | 10.24" X 4.06" X 1.81" |
| PSHK-288W-24V | CLASS 2 | 11.85" X 4.25" X 1.82" |
| PSHK-300W-24V | | 10.24" X 4.25" X 1.81" |

