

SLINQ MINI

MINI FLEXIBLE 360° ROUND NEON SERIES

Project _____

Location _____

Quote/ Ref # _____

Set your creativity free and unleash the endless possibilities. Different mounting options allow for pendants, suspended mounts, flush mounts, arches and free form designs. The 360° light source gives illumination no matter how the fixture is mounted. Discover what you can create with the **Slinq Mini** Neon Series.

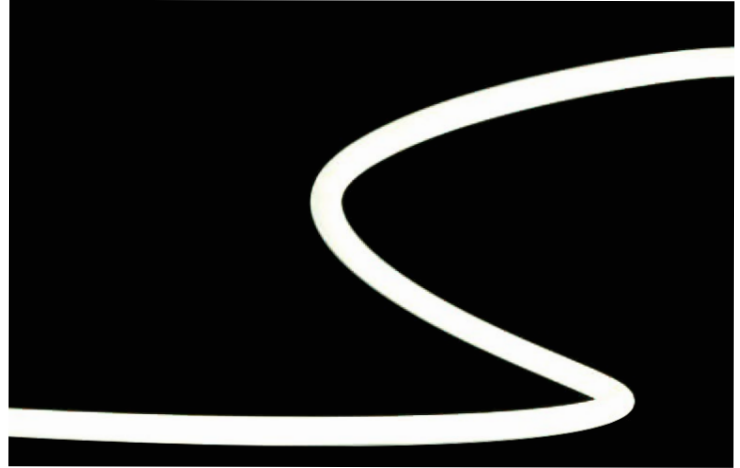

SPECIFICATIONS

POWER CONSUMPTION	3W per Ft.
LUMEN OUTPUT	204 Lm/ Ft.
CRI	90+
COLOR TEMPERATURE	23K/ 27K/ 30K/ 43K
MAXIMUM RUN LENGTH	16.4 Ft. (24V) 32.8 Ft. (48V)
CUTTABLE	Every 1 in. (24V) Every 2 in. (48V)
OPERATING VOLTAGE	24V/ 48V
STORAGE TEMPERATURE	0°C (0°F) to 60°C (140°F)
OPERATING TEMPERATURE	-25°C (-13°F) to 55°C (131°F)
BEAM ANGLE	360°
IP RATING	IP65 Outdoor/ Wet Location
LUMEN MAINTENANCE	50,000 Hrs.

FEATURES

- 360° Light Source
- Multiple Mounting Options
- Universal Dimming
- Available in 24V and 48V DC
- IP65 Outdoor Rated
- Factory-Installed Power Feed
- Injection Moulded End-Caps
- Ideal for Decorative, Retail, Artistic Lighting



MODEL	LENGTH	COLOR TEMP	VOLTAGE	POWER FEED
SLQ-15	Per Inch Per Inch	23K 2300K 27K 2700K 30K 3000K 43K 4300K	24V 24 Volts 48V 48 Volts	EF72 72" End Feed
	*1 = Custom length per In. (24V cuttable every 1") (48V cuttable every 2")			*MAX RUN: 24V - 16.4 Ft. 48V - 32.8 Ft.

SLINQ MINI

MINI FLEXIBLE 360° ROUND NEON SERIES

ACCESSORIES

SLQ15-MC
MOUNTING CLIP
*SCREWS INCLUDED

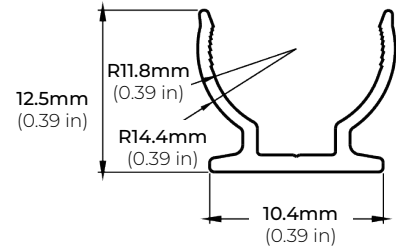
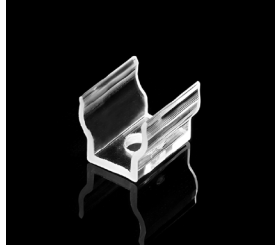

SLQ15-PC39
39" MOUNTING CHANNEL
*SCREWS INCLUDED

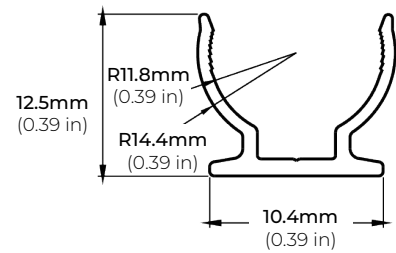

DOUBLE-END SUSPENSION KIT

SLQ15-DS-BK
BLACK DOUBLE-END SUSPENSION KIT

SLQ15-DS-WH
WHITE DOUBLE-END SUSPENSION KIT

*SCREWS INCLUDED

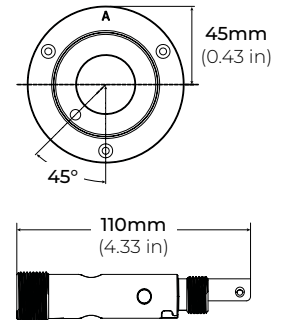
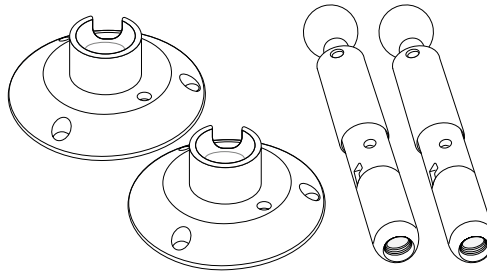

DIMENSIONS

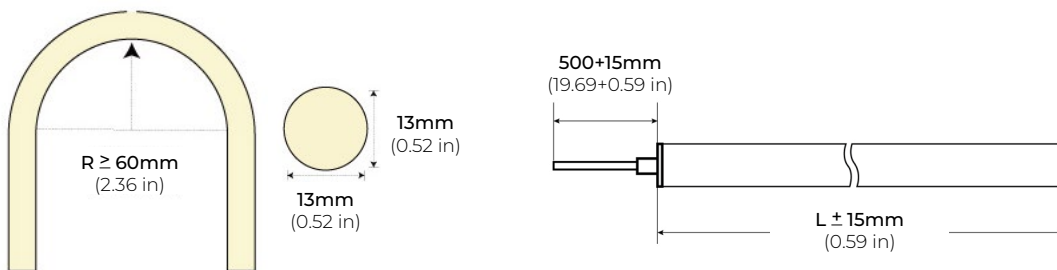

SLINQ MINI

MINI FLEXIBLE 360° ROUND NEON SERIES

COMPATABLE 24V TRANSFORMERS

PSDL SERIES TRIAC DIMMABLE

PSDL-30W-24V	CLASS 2	6.5" X 3.63" X 1.58"
PSDL-60W-24V	CLASS 2	7.4" X 3.63" X 1.58"
PSDL-96W-24V	CLASS 2	8.67" X 3.67 X 1.62"
PSDL-150W-24V		10.25" X 4.06" X 1.82"
PSDL-192W-24V	CLASS 2	11" X 4" X 1.82"
PSDL-200W-24V		10.25" X 4.06" X 1.82"
PSDL-288W-24V	CLASS 2	11.85" X 4.25" X 1.82"
PSDL-300W-24V		10.25" X 4.06" X 1.82"

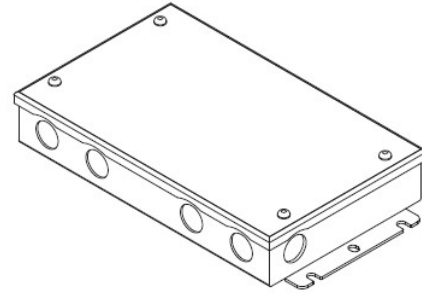

PSDH SERIES HIGH PERFORMANCE MAGNETIC LOW VOLTAGE (MLV)

PSDH-48W-24V	CLASS 2	11.25" X 3.38" X 3.38"
PSDH-96W-24V	CLASS 2	11.25" X 3.38" X 3.37"
PSDH-288W-24V	CLASS 2	14.25" X 8.43" X 4.43"

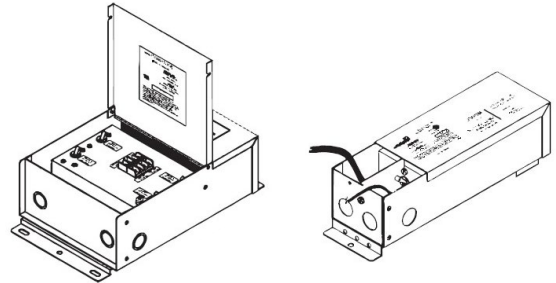

PSRX SERIES 4-IN-1 DIMMING DRIVER W/ JUNCTION BOX

PSRX-30W-24V	CLASS 2	6.5" X 3.72" X 1.57"
PSRX-60W-24V	CLASS 2	7.4" X 3.72" X 1.57"
PSRX-96W-24V	CLASS 2	8.66" X 3.72" X 1.57"
PSRX-150W-24V		10.24" X 4.13" X 1.77"
PSRX-192W-24V	CLASS 2	11" X 4" X 1.82"
PSRX-200W-24V		10.24" X 4.13" X 1.77"
PSRX-288W-24V	CLASS 2	11.85" X 4.25" X 1.82"
PSRX-300W-24V		10.94" X 4.33" X 1.77"

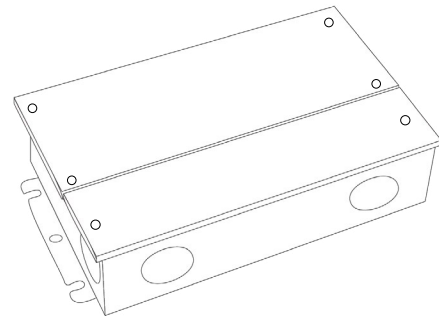

SLINQ MINI

MINI FLEXIBLE 360° ROUND NEON SERIES

COMPATABLE 24V TRANSFORMERS

LUTRON 1%
3-WIRE DIMMING

L3DA4U1UKL-CV240 CLASS 2 4.89" X 4" X 2.62"

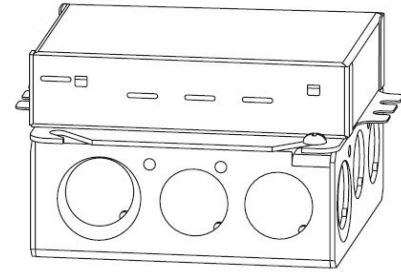

PSDE-96W-24V-ECO CLASS 2 10.5" X 3.0" X 2.0"

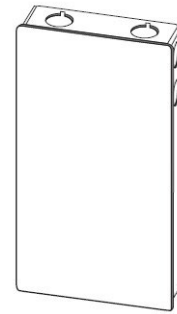

COMPATABLE 24V NON-DIMMING DRIVERS

PSHK SERIES
NON-DIMMING CONSTANT VOLTAGE WITH JUNCTION BOX

PSHK-30W-24V	CLASS 2	6.5" X 3.6" X 1.02"
PSHK-60W-24V	CLASS 2	7.4" X 3.62" X 1.02"
PSHK-96W-24V	CLASS 2	8.66" X 3.66" X 1.61"
PSHK-150W-24V		10.24" X 4.06" X 1.81"
PSHK-200W-24V		10.24" X 4.06" X 1.81"
PSHK-288W-24V	CLASS 2	11.85" X 4.25" X 1.82"
PSHK-300W-24V		10.24" X 4.25" X 1.81"

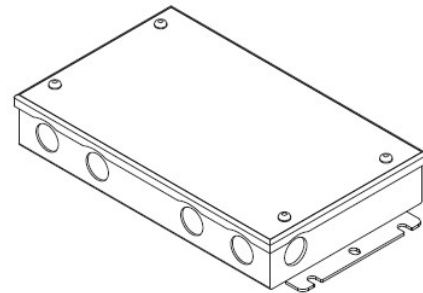

COMPATABLE 48V TRANSFORMERS

PSRX SERIES
4-IN-1 DIMMING DRIVER W/ JUNCTION BOX

PSRX-200W-48V-UNV	10.24" X 4.13" X 1.77"
PSRX-300W-48V-UNV	10.24" X 4.13" X 1.77"

