

# LNT-85

## IP68 FLEXIBLE LED NEON SERIES

Project \_\_\_\_\_  
Location \_\_\_\_\_  
Quote/ Ref # \_\_\_\_\_

The **LNT-85** is a high performance flexible LED fixture that is useful in a wide variety of indoor or outdoor applications where a smooth surface or continuous line of light is desired. It is a flexible strip light that can bend around contours or tight curves horizontally or vertically without being damaged.



### SPECIFICATIONS

INPUT VOLTAGE	24V DC Constant Voltage
POWER CONSUMPTION	5.1W
LUMEN OUTPUT	554 Lm./ Ft. (VB) 462 Lm./ Ft. (HB)
CRI	90+
COLOR TEMPERATURE	22K/ 27K/ 30K/ 35K/ 40K/ 50K
DIMMING/ CONTROL	MLV, ELV, 0-10, and TRIAC
MAXIMUM RUN LENGTH	23 Ft.
CUTTABLE	Every 55.6mm (2.19 in)
POWER FACTOR	≤1
STORAGE TEMPERATURE	-40°F (-40°C) to 140°F (60°C)
OPERATING TEMPERATURE	-40°F (-40°C) to 113°F (45°C)
BEAM ANGLE	120°
HUMIDITY	0-95% Non Condensing
IP RATING	IP68
CERTIFICATIONS	UL Listed
LUMEN MAINTENANCE	50,000 Hrs.

### FEATURES

- High color consistency
- Smooth illumination
- Continuous run length up to 23 Ft.
- Dimmable with CORE dimmable drivers
- UV Resistant
- UL Listed

### LUMENS

CCT	VERTICAL BEND (Lm/ FT)	HORIZONTAL BEND (Lm/ FT)	CRI
2200K	456	380	90+
2700K	494	412	90+
3000K	494	412	90+
3500K	533	444	90+
4000K	533	444	90+
5000K	554	462	90+



MODEL	LIGHT SURFACE	COLOR TEMP	VOLTAGE	LENGTH	POWER FEED	FEED LENGTH
LNT-85	HB Horizontal Bend	22K 2700K	24 24V DC	Please refer to page 4 for exact lengths with corresponding ordering codes.	IP68EF End Feed	HW3 3 in. Power Feed
		27K 2700K			IP68SFL Side Feed Left	HW10 10 in. Power Feed
	30K 3000K	IP68SFR Side Feed Right			HW15 15 in. Power Feed	
	35K 3500K	IP68BF Bottom Feed			HW30 30 in. Power Feed	
	40K 4000K				HW50 50 in. Power Feed	
	VB Vertical Bend	50K 5000K				

# LNT-85

## IP68 FLEXIBLE LED NEON SERIES

### DIMENSIONS

#### LNT-85-VB

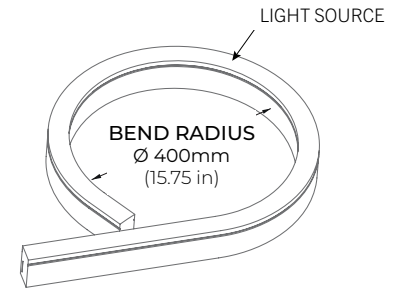
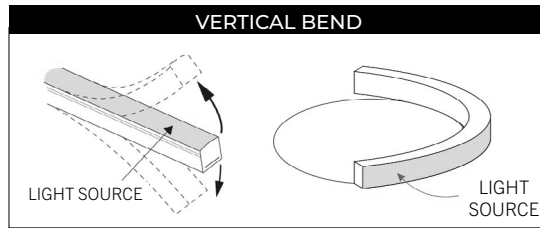
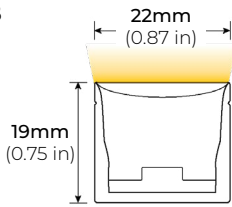

#### LNT-85-HB

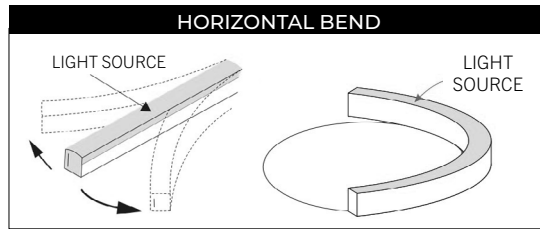
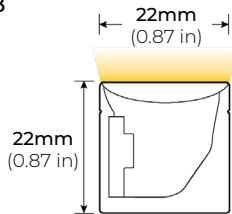

\* LED strip only bends along vertical axis. Bending the LED strip horizontally (perpendicular) to the light surface risks damage to the LED strip. Do **NOT** bend more than the indicated bend radius (shown above). Doing so will damage the LED strip.

### COMPATIBLE ACCESSORIES

#### ALUMINUM PROFILE

LNT85-AC2  
2" PROFILE

LNT85-AC39  
39" PROFILE

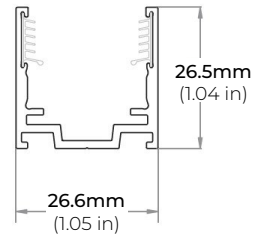
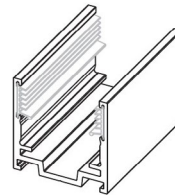

#### FLANGED ALUMINUM PROFILE

LNT65-RS39  
39" PROFILE

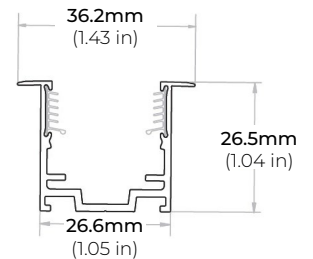
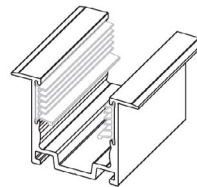

# LNT-85

## IP68 FLEXIBLE LED NEON SERIES

### IP68 POWER FEED

IP68EF  
END FEED

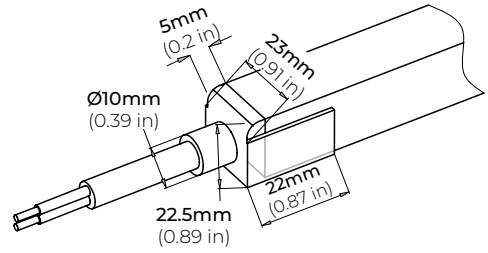

IP68SFL  
SIDE FEED LEFT

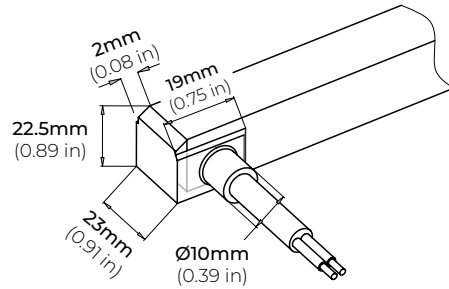

IP68SFR  
SIDE FEED RIGHT

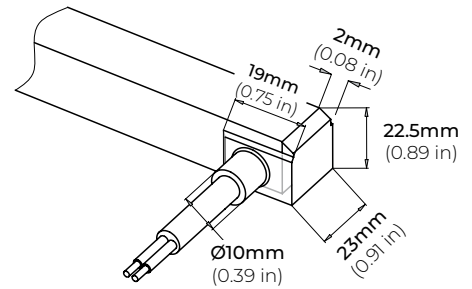

IP68BF  
BOTTOM FEED

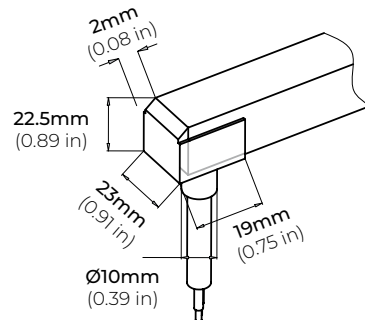

# LNT-85

## IP68 FLEXIBLE LED NEON SERIES

### CUTTING LENGTH CODES

LNT-85 Series is cuttable every 2.19" (5.56CM). Please refer to the chart below to determine actual lengths once LED is cut versus actual lengths required or specified.

Total Length Calculation = Order Code Length + End Feed option Length  
**Example: 33.45" Total Length = Order Code 15 (32.85") + (0.60") End Feed**

POWER FEED OPTION	LENGTH
END FEED	0.60"
SIDE FEED	0.20"
BOTTOM FEED	0.20"

### CUTTING LENGTH INCREMENT TABLE

CODE	LENGTH (CM)	LENGTH (IN)
1	5.56	2.19
2	11.12	4.38
3	16.68	6.57
4	22.24	8.76
5	27.8	10.95
6	33.36	13.14
7	38.92	15.33
8	44.48	17.52
9	50.04	19.71
10	55.6	21.9
11	61.16	24.09
12	66.72	26.28
13	72.28	28.47
14	77.84	30.66
15	83.4	32.85
16	88.96	35.04
17	94.52	37.23
18	100.08	39.42
19	105.64	41.61
20	111.2	43.8
21	116.76	45.99
22	122.32	48.18
23	127.88	50.37
24	133.44	52.56
25	139	54.75
26	144.56	56.94
27	150.12	59.13
28	155.68	61.32
29	161.24	63.51
30	166.8	65.7
31	172.36	67.89
32	177.92	70.08
33	183.48	72.27
34	189.04	74.46
35	194.6	76.65
36	200.16	78.84
37	205.72	81.03
38	211.28	83.22
39	216.84	85.41
40	222.4	87.6

CODE	LENGTH (CM)	LENGTH (IN)
41	227.96	89.79
42	233.52	91.98
43	239.08	94.17
44	244.64	96.36
45	250.2	98.55
46	255.76	100.74
47	261.32	102.93
48	266.88	105.12
49	272.44	107.31
50	278	109.5
51	283.56	111.69
52	289.12	113.88
53	294.68	116.07
54	300.24	118.26
55	305.8	120.45
56	311.36	122.64
57	316.92	124.83
58	322.48	127.02
59	328.04	129.21
60	333.6	131.4
61	339.16	133.59
62	344.72	135.78
63	350.28	137.97
64	355.84	140.16
65	361.4	142.35
66	366.96	144.54
67	372.52	146.73
68	378.08	148.92
69	383.64	151.11
70	389.2	153.3
71	394.76	155.49
72	400.32	157.68
73	405.88	159.87
74	411.44	162.06
75	417	164.25
76	422.56	166.44
77	428.12	168.63
78	433.68	170.82
79	439.24	173.01
80	444.8	175.2

CODE	LENGTH (CM)	LENGTH (IN)
81	450.36	177.39
82	455.92	179.58
83	461.48	181.77
84	467.04	183.96
85	472.6	186.15
86	478.16	188.34
87	483.72	190.53
88	489.28	192.72
89	494.84	194.91
90	500.4	197.1
91	505.96	199.29
92	511.52	201.48
93	517.08	203.67
94	522.64	205.86
95	528.2	208.05
96	533.76	210.24
97	539.32	212.43
98	544.88	214.62
99	550.44	216.81
100	556	219

# LNT-85

## IP68 FLEXIBLE LED NEON SERIES

### COMPATIBLE TRANSFORMERS

#### PSDL SERIES TRIAC DIMMABLE

PSDL-30W-24V	CLASS 2	6.5" X 3.63" X 1.58"
PSDL-60W-24V	CLASS 2	7.4" X 3.63" X 1.58"
PSDL-96W-24V	CLASS 2	8.67" X 3.67 X 1.62"
PSDL-150W-24V		10.25" X 4.06" X 1.82"
PSDL-192W-24V	CLASS 2	11" X 4" X 1.82"
PSDL-200W-24V		10.25" X 4.06" X 1.82"
PSDL-288W-24V	CLASS 2	11.85" X 4.25" X 1.82"
PSDL-300W-24V		10.25" X 4.06" X 1.82"

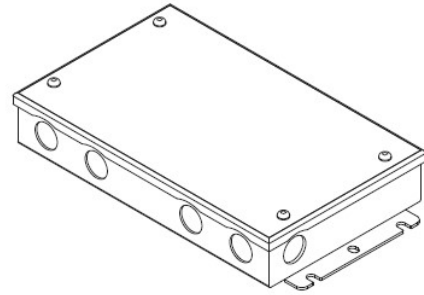

#### PSDH SERIES HIGH PERFORMANCE MAGNETIC LOW VOLTAGE (MLV)

PSDH-48W-24V	CLASS 2	11.25" X 3.38" X 3.38"
PSDH-96W-24V	CLASS 2	11.25" X 3.38" X 3.37"
PSDH-288W-24V	CLASS 2	14.25" X 8.43" X 4.43"

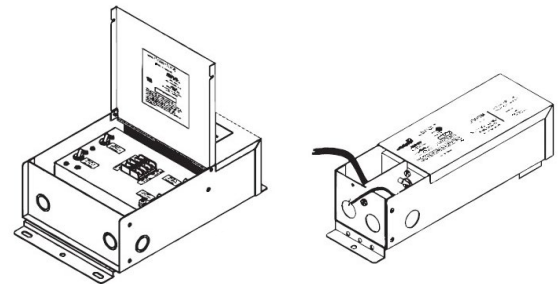

#### PSRX SERIES 4-IN-1 DIMMING DRIVER

PSRX-30W-24V	CLASS 2	6.5" X 3.72" X 1.57"
PSRX-60W-24V	CLASS 2	7.4" X 3.72" X 1.57"
PSRX-96W-24V	CLASS 2	8.66" X 3.72" X 1.57"
PSRX-150W-24V		10.24" X 4.13" X 1.77"
PSRX-192W-24V	CLASS 2	11" X 4" X 1.82"
PSRX-200W-24V		10.24" X 4.13" X 1.77"
PSRX-288W-24V	CLASS 2	11.85" X 4.25" X 1.82"
PSRX-300W-24V		10.94" X 4.33" X 1.77"

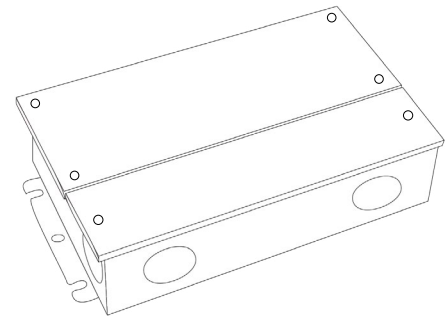

#### PSVT SERIES 0-10V DIMMING WITH JUNCTION BOX

PSVT-60W-24V-UNV-010	CLASS 2	7.4" X 3.72" X 1.57"
PSVT-96W-24V-UNV-010	CLASS 2	8.66" X 3.72" X 1.57"
PSVT-200W-24V-UNV-010		10.24" X 4.13" X 1.77"
PSVT-288W-24V-UNV-010	CLASS 2	11.85" X 4.25" X 1.81"
PSVT-300W-24V-UNV-010		10.94" X 4.33" X 1.77"

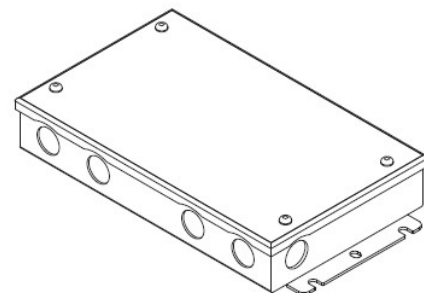

# LNT-85

## IP68 FLEXIBLE LED NEON SERIES

### COMPATIBLE TRANSFORMERS

#### PSDE SERIES 0-10V DIMMING W/ JUNCTION BOX

PSDE-60W-24V-010-JB	CLASS 2	12.1" X 2.36" X 1.4"
PSDE-96W-24V-010-JB	CLASS 2	12.1" X 2.36" X 1.4"

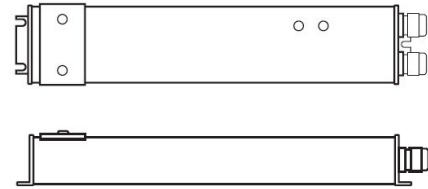

#### LUTRON 1% 3-WIRE DIMMING

L3DA4U1UKL-CV240	CLASS 2	4.89" X 4" X 2.62"
------------------	---------	--------------------

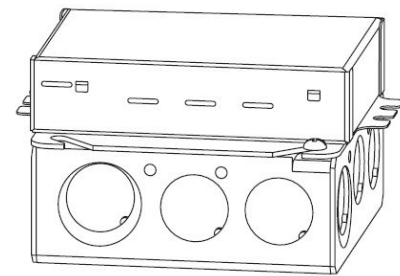

PSDE-96W-24V-ECO	CLASS 2	10.5" X 3.0" X 2.0"
------------------	---------	---------------------

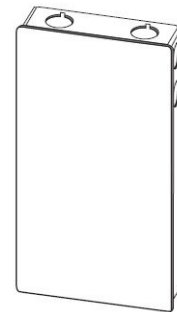

### NON-DIMMING DRIVERS (COMPATABLE WITH ALL SYSTEMS)

#### PSHK SERIES NON-DIMMING CONSTANT VOLTAGE WITH JUNCTION BOX

PSHK-30W-24V	CLASS 2	6.5" X 3.6" X 1.02"
PSHK-60W-24V	CLASS 2	7.4" X 3.62" X 1.02"
PSHK-96W-24V	CLASS 2	8.66" X 3.66" X 1.61"
PSHK-150W-24V		10.24" X 4.06" X 1.81"
PSHK-200W-24V		10.24" X 4.06" X 1.81"
PSHK-288W-24V	CLASS 2	11.85" X 4.25" X 1.82"
PSHK-300W-24V		10.24" X 4.25" X 1.81"

