

LNE-30

3W IP64/ IP67 FLEXIBLE LED NEON SERIES

Project _____
Location _____
Quote/ Ref # _____

The **LNE-30 Series** is a high performance flexible and affordable LED fixture designed as a neon replacement and is also useful in a wide variety of indoor or outdoor applications where a smooth surface or continuous line of light is desired. It is a flexible strip light that can bend around contours or tight curves horizontally or vertically without being damaged.

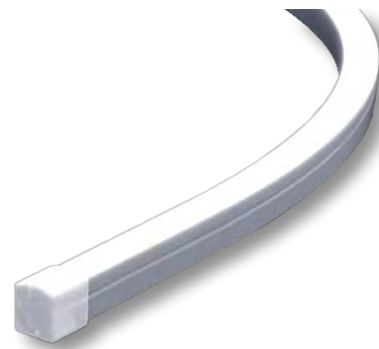

SPECIFICATIONS

| | |
|-----------------------|--|
| POWER CONSUMPTION | 3W per Ft. |
| LUMEN OUTPUT | 215 Lumens per Ft. (30K) |
| CRI | 90+ |
| COLOR TEMPERATURE | 24K/ 27K/ 30K/ 35K/ 40K/ 50K RD/ GN/ BL/ AM/ PK/ YW |
| DIMMING/ CONTROL | MLV, ELV, 0-10 and TRIAC |
| MAXIMUM RUN LENGTH | 32 Ft. |
| CUTTABLE | Every 1.9 in. (50mm) |
| OPERATING VOLTAGE | 24V DC |
| STORAGE TEMPERATURE | -40°F (-40°C) to 176°F (80°C) |
| OPERATING TEMPERATURE | -4°F (-20°C) to 113°F (45°C) |
| BEAM ANGLE | 120° |
| IP RATING | IP64/ IP67 |
| CERTIFICATIONS | UL Listed |
| LUMEN MAINTENANCE | 50,000 Hrs. |

FEATURES

- High color consistency and smooth illumination
- Multiple CCT options available
- Continuous run length up to 32 Ft.
- Cuttable every 1.9 in. (50mm)
- Bottom, Side and End Feed options
- UL Listed



| MODEL | LIGHT SURFACE | COLOR TEMP | VOLT | LENGTH | IP RATING | POWER FEED | FEED LENGTH | | |
|--------|------------------------|---------------------|---------------------|---------------------|-----------------------|---------------------|--------------------------------|-------------------------------|----------------------------------|
| LNE-30 | TP Top Bend | 24K 2400K | RD Red | 24 24V DC | 1'X per Ft. | IP64 Damp | HW3 3 Ft. Power Feed | | |
| | SB Side Bend | 27K 2700K | GN Green | | | | IP67 Wet | SFL Side Feed Left | HW10 10 Ft. Power Feed |
| | | 30K 3000K | BL Blue | | | | | SFR Side Feed Right | HW15 15 Ft. Power Feed |
| | | 35K 3500K | AM Amber | | | | | EF End Feed | HW30 30 Ft. Power Feed |
| | | 40K 4000K | PK Pink | | | | | | HW50 50 Ft. Power Feed |
| | | 50K 5000K | YW Yellow | | | | | | |
| | | | | | | | | | |

*1 = Custom length per FT. (cuttable every 1.9")

LNE-30

3W IP64/ IP67 FLEXIBLE LED NEON SERIES

DIMENSIONS

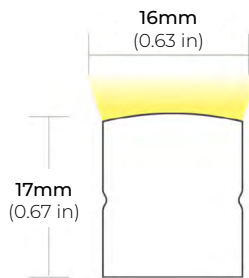

LNE-30-TP (TOP BEND)

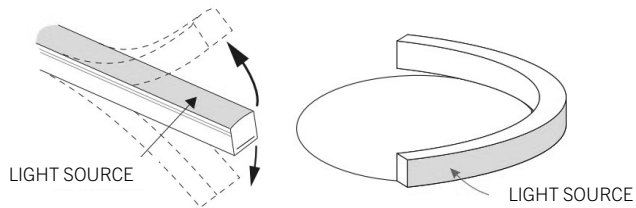

LNE-30-SB (SIDE BEND)

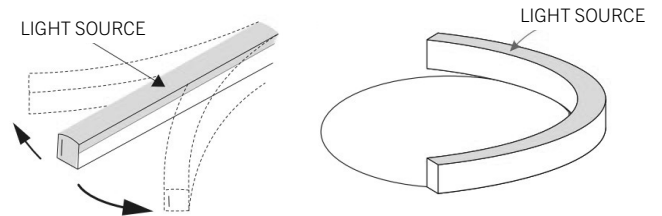

COMPATIBLE ACCESSORIES

SELF LOCKING ALUMINUM PROFILE

LNE30-AC2
2" PROFILE

LNE30-AC39
39" PROFILE

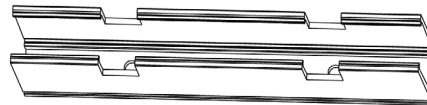

LNE-30

3W IP64/ IP67 FLEXIBLE LED NEON SERIES

POWER FEEDS

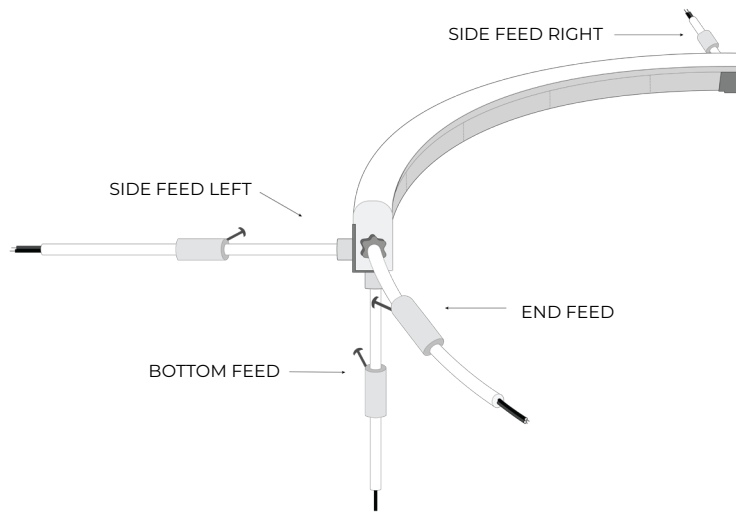

BF
BOTTOM FEED

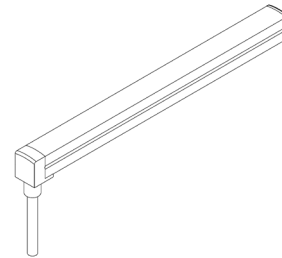

SFL
SIDE LEFT FEED

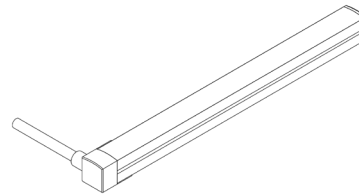

SFR
SIDE RIGHT FEED

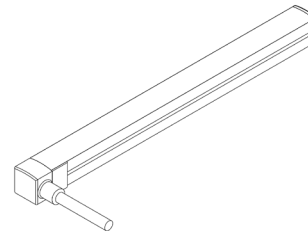

EF
END FEED

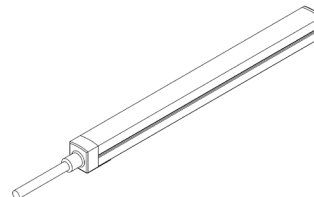

LNE-30

3W IP64/ IP67 FLEXIBLE LED NEON SERIES

COMPATIBLE TRANSFORMERS

PSDL SERIES TRIAC DIMMABLE

| | | |
|---------------|---------|------------------------|
| PSDL-30W-24V | CLASS 2 | 6.5" X 3.63" X 1.03" |
| PSDL-60W-24V | CLASS 2 | 7.4" X 3.63" X 1.03" |
| PSDL-96W-24V | CLASS 2 | 8.67" X 3.67" X 1.62" |
| PSDL-150W-24V | | 8.67" X 3.67" X 1.62" |
| PSDL-192W-24V | CLASS 2 | 10.25" X 4.06" X 1.82" |
| PSDL-200W-24V | | 10.25" X 4.06" X 1.82" |
| PSDL-288W-24V | CLASS 2 | 10.25" X 4.06" X 1.82" |
| PSDL-300W-24V | | 10.25" X 4.06" X 1.82" |

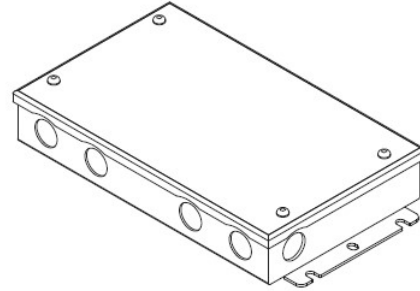

PSDH SERIES HIGH PERFORMANCE MAGNETIC LOW VOLTAGE (MLV)

| | | |
|---------------|---------|------------------------|
| PSDH-48W-24V | CLASS 2 | 11.25" X 3.37" X 3.25" |
| PSDH-96W-24V | CLASS 2 | 11.25" X 3.37" X 3.25" |
| PSDH-288W-24V | CLASS 2 | 14.25" X 8.43" X 4.43" |

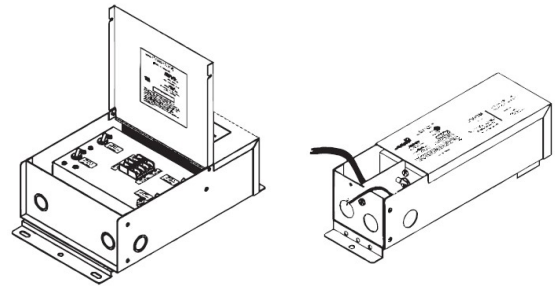

PSRX SERIES 4-IN-1 DIMMING DRIVER

| | | |
|---------------|---------|------------------------|
| PSRX-30W-24V | CLASS 2 | 6.5" X 3.72" X 1.57" |
| PSRX-60W-24V | CLASS 2 | 7.4" X 3.72" X 1.57" |
| PSRX-96W-24V | CLASS 2 | 8.66" X 3.72" X 1.57" |
| PSRX-150W-24V | | 10.24" X 4.13" X 1.77" |
| PSRX-192W-24V | CLASS 2 | 11" X 4" X 1.82" |
| PSRX-200W-24V | | 10.24" X 4.13" X 1.77" |
| PSRX-288W-24V | CLASS 2 | 11.85" X 4.25" X 1.82" |
| PSRX-300W-24V | | 10.94" X 4.33" X 1.77" |

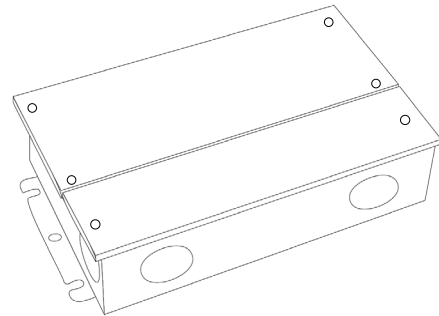

PSVT SERIES 0-10V DIMMING DRIVER

| | | |
|---------------|---------|------------------------|
| PSVT-60W-24V | CLASS 2 | 7.4" X 3.72" X 1.57" |
| PSVT-96W-24V | CLASS 2 | 8.66" X 3.72" X 1.57" |
| PSVT-200W-24V | | 10.24" X 4.13" X 1.77" |
| PSVT-288W-24V | CLASS 2 | 11.85" X 4.25" X 1.81" |
| PSVT-300W-24V | | 10.94" X 4.33" X 1.77" |

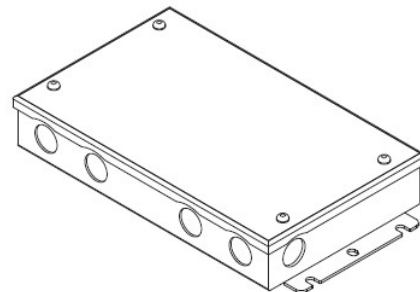

LNE-30

3W IP64/ IP67 FLEXIBLE LED NEON SERIES

COMPATIBLE TRANSFORMERS

PSDE SERIES

0-10V DIMMING W/ JUNCTION BOX

| | | |
|---------------------|---------|----------------------|
| PSDE-60W-24V-010-JB | CLASS 2 | 12.1" X 2.36" X 1.4" |
| PSDE-96W-24-010-JB | CLASS 2 | 12.1" X 2.36" X 1.4" |

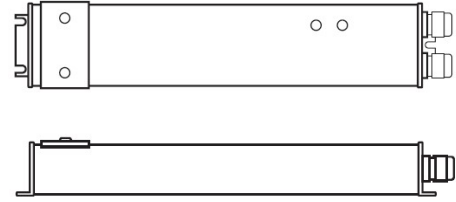

LUTRON 1%

3-WIRE DIMMING

| | | |
|------------------|---------|--------------------|
| L3DA4U1UKL-CV240 | CLASS 2 | 4.89" X 4" X 2.62" |
|------------------|---------|--------------------|

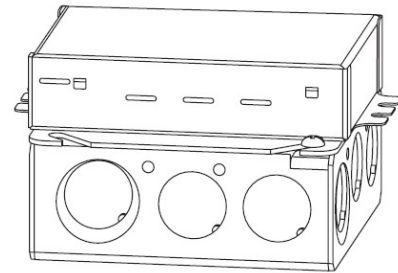

| | | |
|------------------|---------|---------------------|
| PSDE-96W-24V-ECO | CLASS 2 | 10.5" X 3.0" X 2.0" |
|------------------|---------|---------------------|

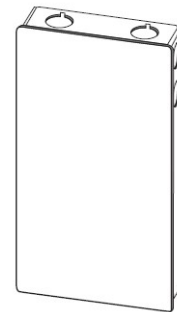

COMPATIBLE NON-DIMMING DRIVERS

PSHK SERIES

NON-DIMMING CONSTANT VOLTAGE WITH JUNCTION BOX

| | | |
|---------------|---------|------------------------|
| PSHK-30W-24V | CLASS 2 | 6.5" X 3.6" X 1.02" |
| PSHK-60W-24V | CLASS 2 | 7.4" X 3.62" X 1.02" |
| PSHK-96W-24V | CLASS 2 | 8.66" X 3.66" X 1.61" |
| PSHK-150W-24V | | 10.24" X 4.06" X 1.81" |
| PSHK-200W-24V | | 10.24" X 4.06" X 1.81" |
| PSHK-288W-24V | CLASS 2 | 11.85" X 4.25" X 1.82" |
| PSHK-300W-24V | | 10.24" X 4.25" X 1.81" |

