

ALP-240N

SURFACE/SUSPENDED/ RECESSED MOUNT LED PROFILE

Project _____

Location _____

Quote/ Ref # _____

The **ALP-240N** is an Architectural Grade LED extrusion profile designed to fit linear LED strips up to 37mm wide. It can be surface, suspended or recessed mount. It features optional corner / angle connectors for seamless attachments. Made from high quality aluminum, these extrusions provide superior thermal management for higher wattage LED strips and prolong the overall lifetime of your lighting system. The ALP-240N is manufactured with a patented frosted diffuser for maximum lumen output and wide beam distribution. The ALP-240N also helps protect LED's from dust and other undesirable elements, which can shorten the lifetime of the LED.



FEATURES

- Customizable
- Ideal for Surface, Suspended and Recessed applications
- Compatible with 37mm (1.46") wide LED strips
- Durable, anodized aluminum
- Frosted lens diffuser included
- Dissipates heat from LED, prolonging its lifetime

SPECIFICATIONS

TYPE	Surface/ Suspended/ Recessed Mount
AVAILABLE LENGTHS	49 in./ 98 in.
FINISH	Anodized Silver
LENS OPTION	Frosted
CHANNEL	ALP-240N
LENS	ALP240N-LN (Included)
END CAP	ALP240N-EC (Included)
WARRANTY	5 Years



MODEL	LENS	LENGTH	FINISH	DRIVER	MOUNTING
ALP-240N	FR Frosted	49 49.25 in.	SI Silver	REM Remote Dimming & Non-Dimming	SF Surface
		98 98.5 in.	CU Custom (Powder Coat)		SUS Suspended
		CC Custom Length			RE Recessed

* Custom color finishes require powder coating. Allow 7 days lead time.

ALP-240N

SURFACE/ SUSPENDED/ RECESSED MOUNT LED PROFILE

DIMENSIONS

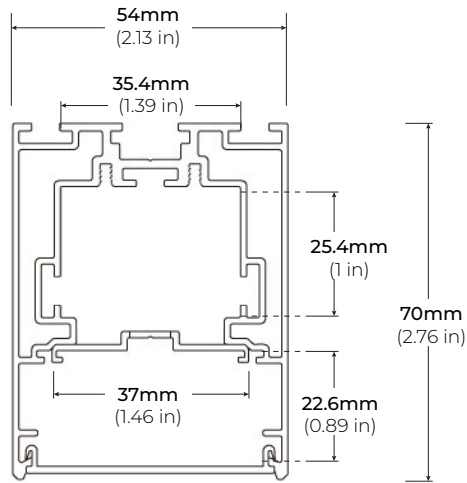

COMPATABLE ACCESSORIES

ALP240N-LN
PLASTIC LENS

* INCLUDED

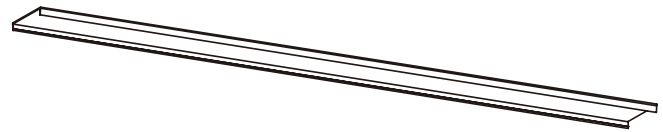

ALP240N-EC
END CAP

* TWO END CAPS INCLUDED WITH EVERY PROFILE

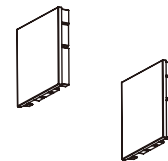

ALP-SC
SEAMLESS CONNECTOR

* SOLD SEPARATELY



ALP-240N-X90
X CONNECTOR

* SOLD SEPARATELY

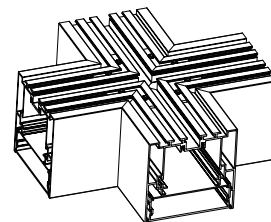

ALP-240N

SURFACE/ SUSPENDED/ RECESSED MOUNT LED PROFILE

COMPATABLE ACCESSORIES

ALP-240N-L90
SIDE L CONNECTOR

* SOLD SEPARATELY

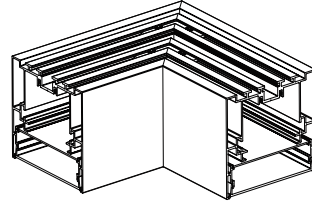

ALP-240N-L90W
OUTSIDE L CONNECTOR

* SOLD SEPARATELY

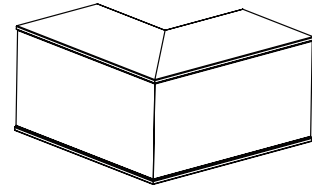

ALP-240N-L90N
INSIDE L CONNECTOR

* SOLD SEPARATELY

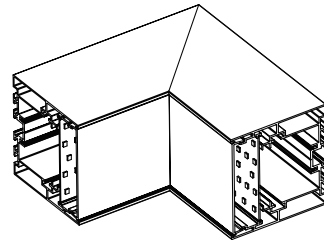

ALP-240N-T90
T CONNECTOR

* SOLD SEPARATELY

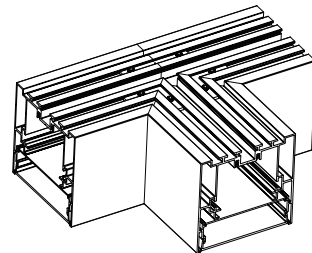

ALP-RE
N-TYPE CLIP

4.33" x 0.98" x 3.25" (L x W x H)

* SOLD SEPARATELY

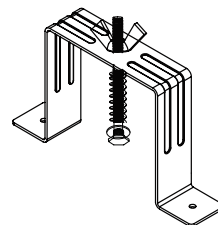

ALP-240N

SURFACE/SUSPENDED/ RECESSED MOUNT LED PROFILE

SUSPENSION KIT ACCESSORIES

ALP-CS12
EUROPEAN CABLE SUSPENSION

* SOLD SEPARATELY

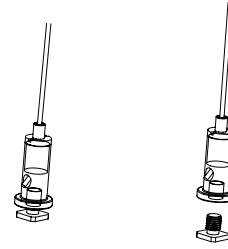

5" JUNCTION BOX POWER FEED

ALP-CF-WH
WHITE POWER FEED

ALP-CF-BK
BLACK POWER FEED

* SOLD SEPARATELY



2" NON-POWER FEED

ALP-CSB-WH-2
2" WHITE FEED

ALP-CSB-BK-2
2" BLACK FEED

* SOLD SEPARATELY

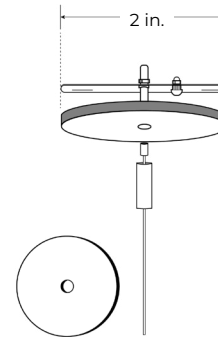

5" JUNCTION BOX NON-POWER FEED

ALP-CSB-WH-5
5" WHITE FEED

ALP-CSB-BK-5
5" BLACK FEED

* SOLD SEPARATELY

