

ALP-40

5MM SURFACE MOUNT PROFILE

Project _____

Location _____

Quote/ Ref # _____

The **ALP-40** is an Architectural-grade LED extrusion designed for surface mount applications, specifically for 5mm (0.2") wide. Made from high quality aluminum and manufactured with a patented frosted diffuser for maximum lumen output and wider beam distribution.



SPECIFICATIONS

TYPE	Surface Mount
AVAILABLE LENGTHS	49.25 in./ 84 in.
FINISH	White/ Black/ Silver
LENS OPTION	Frosted (Included)
CHANNEL	ALP-40
LENS	ALP40-LN (Frosted)
END CAP	ALP40-EC
MOUNTING CLIPS	ALP40-CL
WARRANTY	5 Years

FEATURES

- Customizable
- Compatible with 5mm (0.2") wide LED strips
- Durable, anodized aluminum
- Frosted lens diffuser included
- Protects LED systems from dust and other elements
- Dissipates heat from LED, prolonging its lifetime



MODEL	LENGTH	LENS	FINISH
ALP-40	49 49.25 in.	FR Frosted Lens	WH White
	84 84 in.		BK Black
			SI Silver
			CU Custom (Powder Coat)

* Custom color finishes require powder coating. Allow 7 days lead time.

ALP-40

5MM SURFACE MOUNT PROFILE

DIMENSIONS

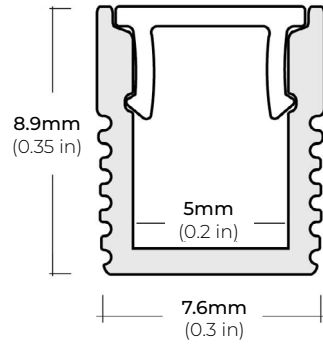

COMPATIBLE ACCESSORIES

ALP-40
ALUMINUM CHANNEL



ALP40-LN
PLASTIC LENS



ALP40-EC
END CAP
* TWO END CAPS INCLUDED

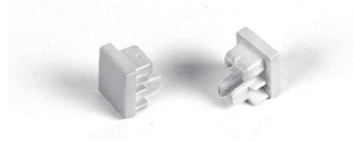

ALP40-CL
METAL MOUNTING CLIPS

