

LFO-60

6W INDOOR/ OUTDOOR LINEAR OPTICAL LED STRIP

Project _____

Location _____

Quote/ Ref # _____

LFO-60 is an indoor and outdoor flexible LED Strip that features the smallest, most discreet optical linear design. Easy to mount and install to nearly any surface and easily adaptable to almost any indoor or outdoor application. Its miniature optics are ideal for grazing, wall washing, cove and other architectural or accent lighting applications. Its silicone encapsulation makes it durable to withstand harsh elements. Available in different color temperatures and field cuttable.



SPECIFICATIONS

INPUT VOLTAGE	24V DC
POWER CONSUMPTION	6W per Ft.
LUMEN OUTPUT	510 Lumens per Ft.
NO. OF LEDS	14 LEDs per Ft.
BEAM ANGLE	10°/ 30°/ 60°/ 30°x50°/ Asymmetric
CRI	90+
COLOR TEMPERATURE	27K/ 30K/ 35K/ 40K/ 50K
DIMMING/ CONTROL	MLV, ELV, 0-10 and TRIAC
MAXIMUM RUN LENGTH	32 Ft.
FIELD CUTTABLE	Every 6.0 in (152.4mm)
IP RATING	IP67 Outdoor/ Wet Rated
LUMEN MAINTENANCE	50,000 Hrs.
CERTIFICATIONS	UL Listed
OPERATING TEMPERATURE	-22°F (-30°C) to +122°F (+50°C)

FEATURES

- 6W per Ft
- 510 Lumens per Ft.
- 90+ CRI
- Flexible, silicone encapsulated
- Field Cuttable*
- Dimmable
- UL Listed

*Indoor installation only



MODEL	COLOR TEMP	LENGTH	OPTICS	VOLTAGE
LFO-60	27K 2700K	1'XX per Ft.	10 10°	24 24V DC
	30K 3000K		30 30°	
	35K 3500K		60 60°	
	40K 4000K		3050 30° x 50°	
	50K 5000K		ASY Asymmetric	

*1 = Custom length per FT. (cuttable every 6")

LFO-60

6W INDOOR/ OUTDOOR LINEAR OPTICAL LED STRIP

DIMENSIONS

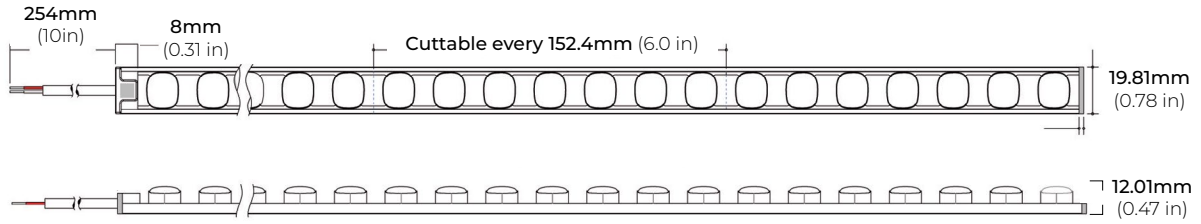

ACCESSORIES

LFO-60-MB
MOUNTING BRACKET
0.82" X 0.79" X 0.3"

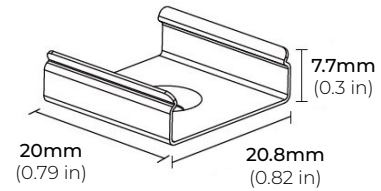

LFO-60-ASB
ADJUSTABLE BRACKET

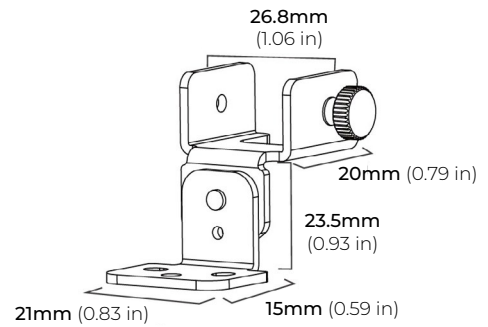

LFO-60-AC48
STANDARD ALUMINUM PROFILE
1.2" X 0.84" X 48"

* COMES WITH CLEAR LENS

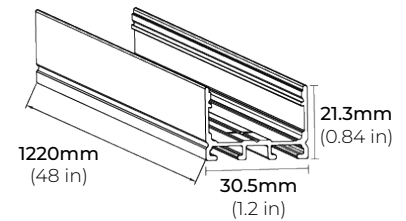

LFO-60-GS48
GLARE SHIELD ALUMINUM PROFILE
0.93" X 0.91" X 48"

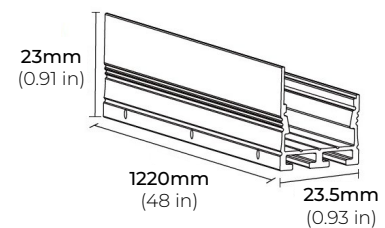

LFO-60

6W INDOOR/ OUTDOOR LINEAR OPTICAL LED STRIP

COMPATIBLE TRANSFORMERS

PSDL SERIES TRIAC DIMMABLE

PSDL-30W-24V	CLASS 2	6.5" X 3.63" X 1.58"
PSDL-60W-24V	CLASS 2	7.4" X 3.63" X 1.58"
PSDL-96W-24V	CLASS 2	8.67" X 3.67 X 1.62"
PSDL-150W-24V		10.25" X 4.06" X 1.82"
PSDL-192W-24V	CLASS 2	11" X 4" X 1.82"
PSDL-200W-24V		10.25" X 4.06" X 1.82"
PSDL-288W-24V	CLASS 2	11.85" X 4.25" X 1.82"
PSDL-300W-24V		10.25" X 4.06" X 1.82"

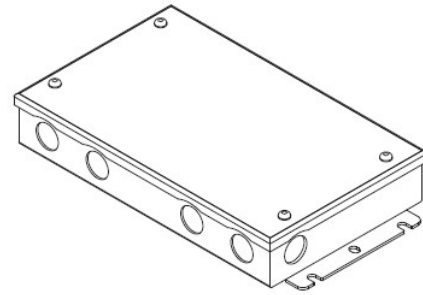

PSDH SERIES HIGH PERFORMANCE MAGNETIC LOW VOLTAGE (MLV)

PSDH-48W-24V	CLASS 2	11.25" X 3.38" X 3.38"
PSDH-96W-24V	CLASS 2	11.25" X 3.37" X 3.37"
PSDH-288W-24V	CLASS 2	14.25" X 8.43" X 4.43"

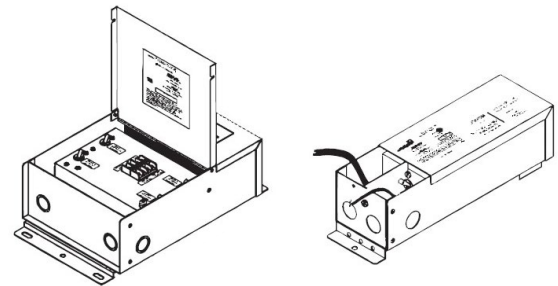

PSDE SERIES 0-10V DIMMING W/ JUNCTION BOX

PSDE-100W-24V-010-JB	CLASS 2	12.32" X 1.77" X 1.67"
----------------------	---------	------------------------

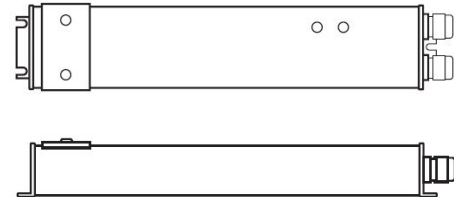

LUTRON 1% 2 OR 3-WIRE DIMMING

LTEA4U1UKL-CV240	CLASS 2	4.89" X 4" X 2.62"
L3DA4U1UKL-CV240	CLASS 2	4.89" X 4" X 2.62"

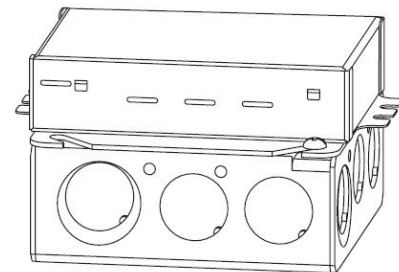

LFO-60

6W INDOOR/ OUTDOOR LINEAR OPTICAL LED STRIP

COMPATIBLE TRANSFORMERS

LUTRON 1%

PSDE-96W-24V-ECO CLASS 2 10.5" X 3.0" X 2.0"

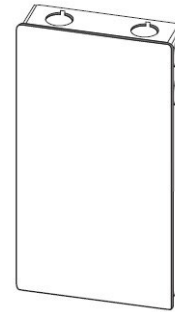

COMPATIBLE NON-DIMMING DRIVERS

PSHK SERIES

NON-DIMMING CONSTANT VOLTAGE WITH JUNCTION BOX

PSHK-30W-24V	CLASS 2	6.5" X 3.6" X 1.02"
PSHK-60W-24V	CLASS 2	7.4" X 3.62" X 1.02"
PSHK-96W-24V	CLASS 2	8.66" X 3.66" X 1.61"
PSHK-150W-24V		10.24" X 4.06" X 1.81"
PSHK-200W-24V		10.24" X 4.06" X 1.81"
PSHK-288W-24V	CLASS 2	11.85" X 4.25" X 1.82"
PSHK-300W-24V		10.24" X 4.25" X 1.81"

