

LFO-60-RGBW

5.8W INDOOR/ OUTDOOR COLOR CHANGING LED STRIP

Project _____
Location _____
Quote/ Ref # _____

LFO-60-RGBW is an indoor and outdoor flexible LED Strip that features the smallest, most discreet optical linear design. Easy to mount and install to nearly any surface and easily adaptable to almost any indoor or outdoor application. Its miniature optics are ideal for grazing, wall washing, cove and other architectural or accent lighting applications. Its silicone encapsulation makes it durable to withstand harsh elements. Available in different color temperatures and field cuttable.



SPECIFICATIONS

INPUT VOLTAGE	24V DC
POWER CONSUMPTION	5.8W/ Ft. <i>(3.4W/ Ft.— RGB) 2.4W/ Ft.— White)</i>
LUMEN OUTPUT	320 Lm/ Ft. <i>(140 Lm/ Ft.— RGB) 170 Lm/ Ft.— White)</i>
NO. OF LEDs	14 LEDs per Ft.
BEAM ANGLE	30°/ 45°/ 60°/ 30° x 50° Asymmetric
COLOR TEMPERATURE	RGB27K/ RGB30K/ RGB40K
DIMMING/ CONTROL	DMX
MAXIMUM RUN LENGTH	32 Ft.
FIELD CUTTABLE	Every 6.0 in (152.4mm)
IP RATING	IP67 Outdoor/ Wet Rated
LUMEN MAINTENANCE	50,000 Hrs.
CERTIFICATIONS	UL Listed
OPERATING TEMPERATURE	-22°F (-30°C) to +122°F (+50°C)

FEATURES

- 5.8W per Ft
- 320 Lm/ Ft.
- Flexible, silicone encapsulated
- Field Cuttable*
- Dimmable
- UL Listed

* Indoor installation only



MODEL	COLOR TEMP	LENGTH	OPTICS	VOLTAGE
LFO-60	RGB27K 2700K + RGB	'XX per Ft.	30 30°	24 24V DC
	RGB30K 3000K+RGB		45 45°	
	RGB40K 4000K+RGB		60 60°	
	3050 30° x 50°			
			ASY Asymmetric	
		*1 = Custom length per FT. (cuttable every 6")		

LFO-60-RGBW

5.8W INDOOR/ OUTDOOR COLOR CHANGING LED STRIP

DIMENSIONS

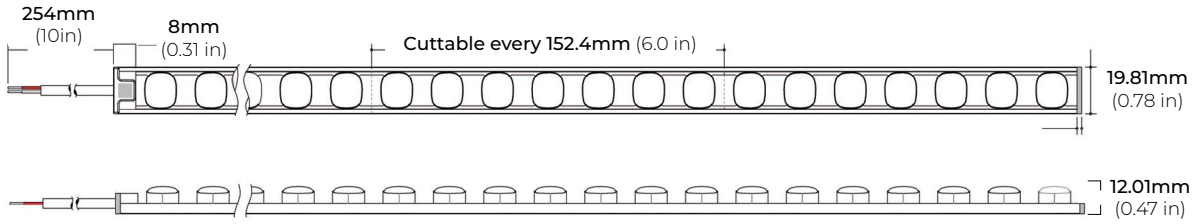

ACCESSORIES

LFO-60-MB
MOUNTING BRACKET
0.82" X 0.79" X 0.3"

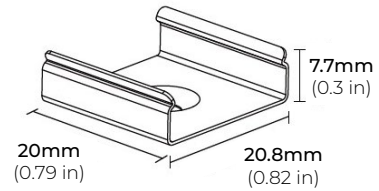

LFO-60-ASB
ADJUSTABLE BRACKET

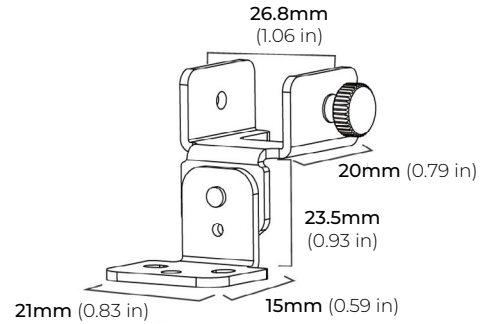

LFO-60-AC48
STANDARD ALUMINUM PROFILE
1.2" X 0.84" X 48"

* COMES WITH CLEAR LENS

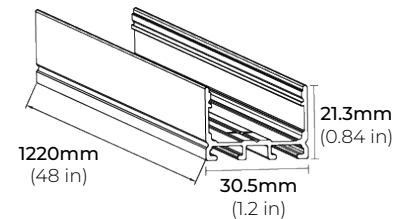

LFO-60-GS48
GLARE SHIELD ALUMINUM PROFILE
0.93" X 0.91" X 48"

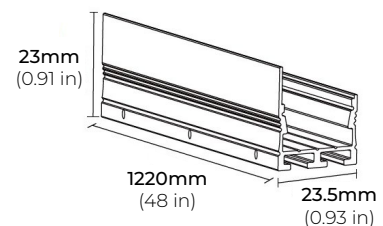

LFO-60-RGBW

5.8W INDOOR/ OUTDOOR COLOR CHANGING LED STRIP

CONTROLLERS

RGB CT600
MULTI-FUNCTION RGBW WALL CONTROLLER

INPUT VOLTAGE 5V DC, 1A
OUTPUT SIGNAL RF 2.4GHZ + DMX512
CONTROL 4 ZONES
WORKING TEMP -20°C ~ 40°C
DIMENSIONS LxWxH (5.19"x7.08"x1.38")

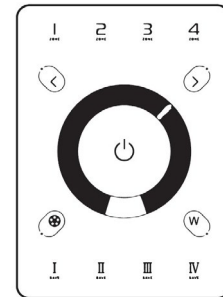

RGB-SDE3
MULTI-FUNCTION RGBW WALL CONTROLLER

INPUT VOLTAGE 6V DC, 0.6A
OUTPUT SIGNAL DMX512 (x2)
PROGRAMMABILITY PC/ MAC/ Tablet/ Smartphone
COLOR Black/ White
CONNECTIONS USB/ Ethernet/ RS232/ CLock/ 8dry contact ports/ 5V output relay
MEMORY MicroSD Card
WORKING TEMP -20°C ~ 40°C
DIMENSIONS LxWxH (5.75"x4.17"x0.43")

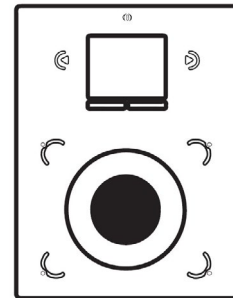

RGB-SCW4
WiFi DMX WALL CONTROLLER

INPUT VOLTAGE 5 - 10V DC, 0.6A
OUTPUT SIGNAL DMX512 (x2)
PROGRAMMABILITY PC/ MAC
COLOR Black/ White
CONNECTIONS USB/ 8dry contact ports/ Open drain output (for relay)
MEMORY Built-In Flash
WORKING TEMP -10°C ~ 45°C
DIMENSIONS LxWxH (5.75"x4.17"x0.43")

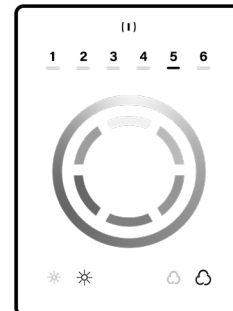

LFO-60-RGBW

5.8W INDOOR/ OUTDOOR COLOR CHANGING LED STRIP

COMPATIBLE DMX DRIVERS

RGB-DMX-4C-WP

3-CHANNEL RGB DMX DECODER

INPUT	12V-36V DC
OUTPUT VOLTAGE	12V-36V DC
OUTPUT AMPS	5A per Channel
OUTPUT CHANNELS	3 Channels
OUTPUT WATTAGE	3 x (167W ~ 333W)
DIMENSIONS	LxWxH (7"x3"x1.5")

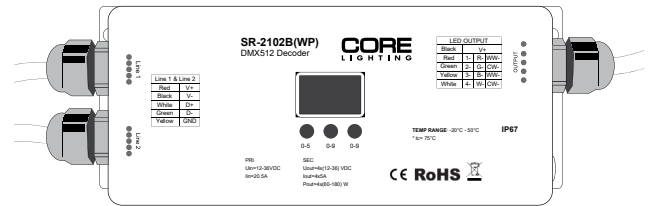

RGB-DMX-4C-RJ45

4-CHANNEL DMX DECODER

INPUT	12V-24V DC
OUTPUT CURRENT	8A X 4CH
OUTPUT POWER	240W(12V), 720W(24V)
OUTPUT CHANNELS	3 or 4 Selectable
DIMENSIONS	LxWxH (7"x1.77"x0.75")

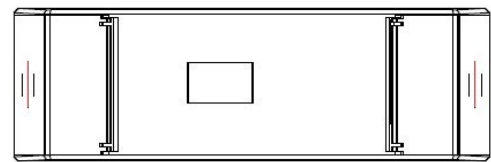

RGB-DMX-5C-XLR

5-CHANNEL DMX DECODER

INPUT	12V-24V-36V DC
OUTPUT VOLTAGE	12V-24V DC
OUTPUT CURRENT	8A X 5CH
OUTPUT WATTAGE	5 x (96W ~ 192W)
DIMENSIONS	LxWxH (6.45"x2.87"x1.5")

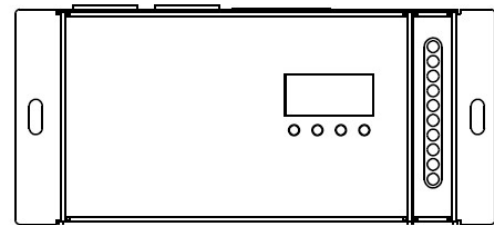

COMPATIBLE NON-DIMMING DRIVERS

PSHK SERIES

NON-DIMMING CONSTANT VOLTAGE WITH JUNCTION BOX

PSHK-30W-24V	CLASS 2	6.5" X 3.6" X 1.02"
PSHK-60W-24V	CLASS 2	7.4" X 3.62" X 1.02"
PSHK-96W-24V	CLASS 2	8.66" X 3.66" X 1.61"
PSHK-150W-24V		10.24" X 4.06" X 1.81"
PSHK-200W-24V		10.24" X 4.06" X 1.81"
PSHK-288W-24V	CLASS 2	11.85" X 4.25" X 1.82"
PSHK-300W-24V		10.24" X 4.25" X 1.81"

