

# SABEL

## INDOOR SUSPENDED LED LUMINAIRE

The **SABEL** is an Architectural Grade LED luminaire made of premium aluminum, offering excellent thermal management for LED strips with higher wattages and extends the total life of your lighting system. Manufactured with a patented frosted diffuser for maximum lumen output and wide beam distribution, this fixture also protects LED's from dust and other undesirable elements, which can shorten the lifetime of the LED.

Project \_\_\_\_\_  
Location \_\_\_\_\_  
Quote/ Ref # \_\_\_\_\_



### SPECIFICATIONS

TYPE	Suspended
INPUT VOLTAGE	24V
WATTAGE	5W/ 6W/ 7W
LUMEN OUTPUT	500 ~ 800 Lm/ Ft. (30K)
COLOR TEMPERATURE	27K/ 30K/ 35K/ 40K/ 50K/ 60K/ RD/ GN/BL/ AM/ PK/ YW/ RGB27K/ RGB30K/ RGB40K/ RGB
LENS OPTION	Frosted
AVAILABLE LENGTHS	49.25 in./ 98.5 in.
DIMMING	MLV, ELV, 0-10, TRIAC and DMX
FINISH	Anodized Silver
TRANSFORMER	Remote
CHANNEL	SAB
LENS (INCLUDED)	SAB-LN
SUSPENSION KIT	ALP-CS12
STRAIGHT CONNECTOR	ALP2000TL-STB

### FEATURES

- Customizable
- Durable, military grade aluminum
- Protects LED systems from dust and other elements
- Dissipates heat from LED, prolonging its lifetime

\*Power supplies available in 120V and 277 options



MODEL	LENGTH	WATTAGE	COLOR TEMP			DRIVER
SAB	4 4 Ft.	L1 5W	27K 2700K	RD* Red	RGBW27K RGB+27K	See Page 3 - 6 for compatible drivers.
	8 8 ft.	L2 6W	30K 3000K	GN* Green	RGBW30K RGB+30K	
	PF Custom Length	L3 7W	35K 3500K	BL* Blue	RGBW40K RGB+40K	
			40K 4000K	AM* Amber	RGB RGB	
			50K 5000K	PK* Pink		
			60K 6000K	YW* Yellow		

\* Available only in 6W

# SABEL

## INDOOR SUSPENDED LED LUMINAIRE

### DIMENSIONS

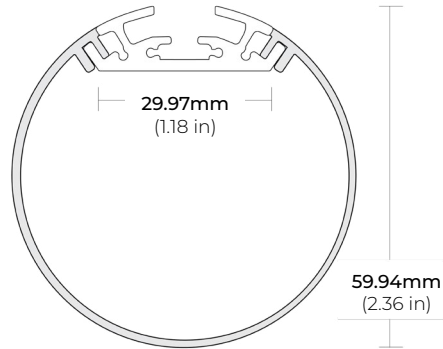

### LUMENS

MODEL	LENS	TYPE	WATTS	LUMEN/ FT.
SAB	FR (FROSTED)	L1	5W	500 LM/ FT.
		L2	6W	620 LM/ FT.
		L3	7W	800 LM/ FT.

### COMPATIBLE ACCESSORIES

ALP2000TL-STB  
STRAIGHT CONNECTOR  
\* SOLD SEPARATELY

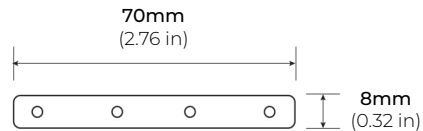

### MOUNTING ACCESSORIES

ALP-CS12  
EUROPEAN CABLE SUSPENSION

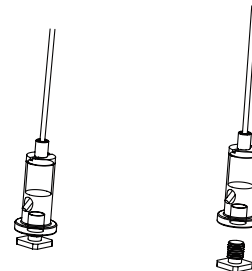

## INDOOR SUSPENDED LED LUMINAIRE

### SUSPENSION KIT ACCESSORIES

#### POWER FEED KIT

ALP-CF-WH  
WHITE POWER FEED KIT

ALP-CF-BK  
BLACK POWER FEED KIT

\* INCLUDED WITH ALP-CS12 MOUNTING OPTION

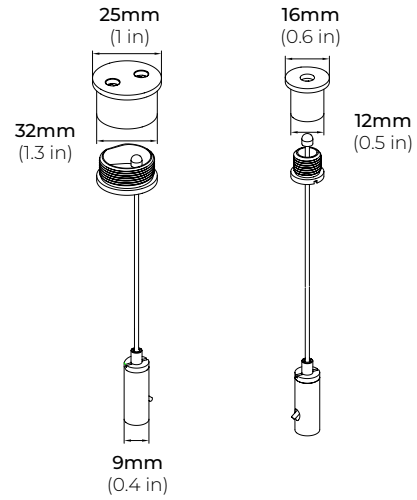

#### 2" NON-POWER FEED KIT

ALP-CSB-WH-2  
2" WHITE FEED KIT

ALP-CSB-BK-2  
2" BLACK FEED KIT

\* INCLUDED WITH ALP-CS12 MOUNTING OPTION

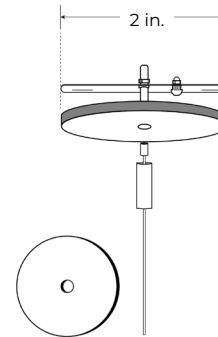

#### 5" NON-POWER FEED KIT

ALP-CSB-WH-5  
5" WHITE FEED KIT

ALP-CSB-BK-5  
5" BLACK FEED KIT

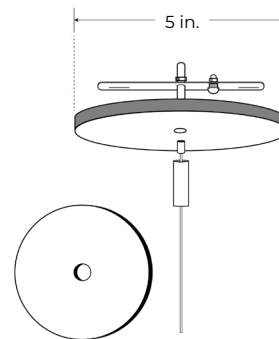

## INDOOR SUSPENDED LED LUMINAIRE

### CONTROLLERS

#### RGB CT600 MULTI-FUNCTION RGBW WALL CONTROLLER

**INPUT VOLTAGE** 5V DC, 1A  
**OUTPUT SIGNAL** RF 2.4GHZ + DMX512  
**CONTROL** 4 ZONES  
**WORKING TEMP** -20°C ~ 40°C  
**DIMENSIONS** LxWxH (5.19"x7.08"x1.38")

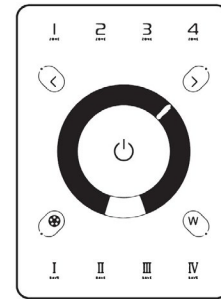

#### RGB-SDE3 MULTI-FUNCTION RGBW WALL CONTROLLER

**INPUT VOLTAGE** 6V DC, 0.6A  
**OUTPUT SIGNAL** DMX512 (x2)  
**PROGRAMMABILITY** PC/ MAC/ Tablet/ Smartphone  
**COLOR** Black/ White  
**CONNECTIONS** USB/ Ethernet/ RS232/ CLock/ 8dry contact ports/ 5V output relay  
**MEMORY** MicroSD Card  
**WORKING TEMP** -20°C ~ 40°C  
**DIMENSIONS** LxWxH (5.75"x4.17"x0.43")

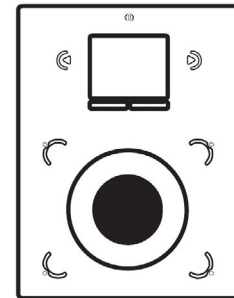

#### RGB-SCW4 WiFi DMX WALL CONTROLLER

**INPUT VOLTAGE** 5 - 10V DC, 0.6A  
**OUTPUT SIGNAL** DMX512 (x2)  
**PROGRAMMABILITY** PC/ MAC  
**COLOR** Black/ White  
**CONNECTIONS** USB/ 8dry contact ports/ Open drain output (for relay)  
**MEMORY** Built-In Flash  
**WORKING TEMP** -10°C ~ 45°C  
**DIMENSIONS** LxWxH (5.75"x4.17"x0.43")

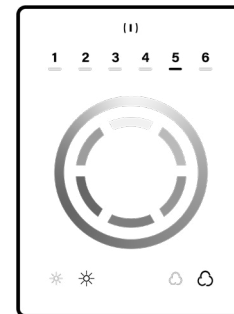

## INDOOR SUSPENDED LED LUMINAIRE

### COMPATIBLE DMX DRIVERS

#### RGB-DMX-4C-RJ45 4-CHANNEL DMX DECODER

INPUT	12V-24V DC
OUTPUT CURRENT	8A X 4CH
OUTPUT POWER	240W(12V), 720W(24V)
OUTPUT CHANNELS	3 or 4 Selectable
DIMENSIONS	LxWxH (7"x1.77"x0.75")

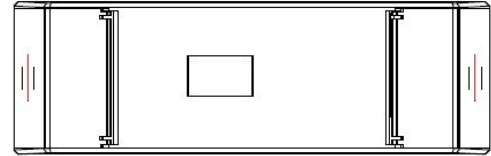

#### RGB-DMX-5C-XLR 5-CHANNEL DMX DECODER

INPUT	12V-24V-36V DC
OUTPUT VOLTAGE	12V-24V DC
OUTPUT CURRENT	8A X 5CH
OUTPUT WATTAGE	5 x (96W ~ 192W)
DIMENSIONS	LxWxH (6.45"x2.87"x1.5")

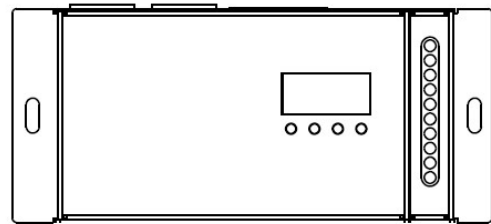

### COMPATIBLE TRANSFORMERS

#### PSDL SERIES TRIAC DIMMABLE

PSDL-30W-24V	CLASS 2	6.5" X 3.63" X 1.03"
PSDL-60W-24V	CLASS 2	7.4" X 3.63" X 1.03"
PSDL-96W-24V	CLASS 2	8.67" X 3.67" X 1.62"
PSDL-150W-24V		8.67" X 3.67" X 1.62"
PSDL-192W-24V	CLASS 2	10.25" X 4.06" X 1.82"
PSDL-200W-24V		10.25" X 4.06" X 1.82"
PSDL-288W-24V	CLASS 2	10.25" X 4.06" X 1.82"
PSDL-300W-24V		10.25" X 4.06" X 1.82"

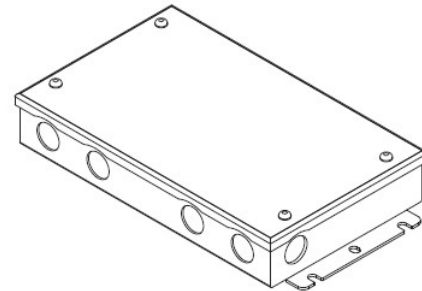

#### PSDH SERIES HIGH PERFORMANCE MAGNETIC LOW VOLTAGE (MLV)

PSDH-48W-24V	CLASS 2	11.25" X 3.37" X 3.25"
PSDH-96W-24V	CLASS 2	11.25" X 3.37" X 3.25"
PSDH-288W-24V	CLASS 2	14.25" X 8.43" X 4.43"

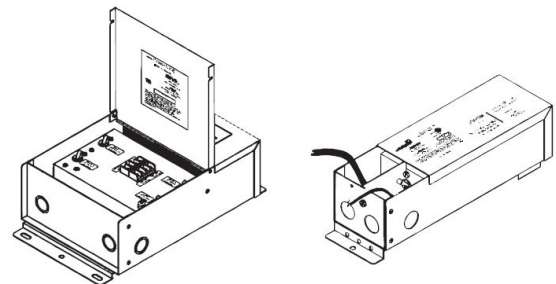

## INDOOR SUSPENDED LED LUMINAIRE

### COMPATIBLE TRANSFORMERS

#### PSRX SERIES

4-IN-1 DIMMING DRIVER

PSRX-30W-24V	CLASS 2	6.5" X 3.72" X 1.57"
PSRX-60W-24V	CLASS 2	7.4" X 3.72" X 1.57"
PSRX-96W-24V	CLASS 2	8.66" X 3.72" X 1.57"
PSRX-150W-24V		10.24" X 4.13" X 1.77"
PSRX-200W-24V		10.24" X 4.13" X 1.77"
PSRX-300W-24V		10.94" X 4.33" X 1.77"

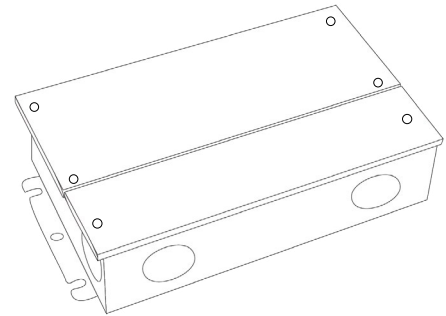

#### PSVT SERIES

4-IN-1 DIMMING DRIVER

PSVT-60W-24V	CLASS 2	7.4" X 3.72" X 1.57"
PSVT-96W-24V	CLASS 2	8.66" X 3.72" X 1.57"
PSVT-200W-24V		10.24" X 4.13" X 1.77"
PSVT-288W-24V	CLASS 2	11.85" X 4.25" X 1.81"
PSVT-300W-24V		10.94" X 4.33" X 1.77"

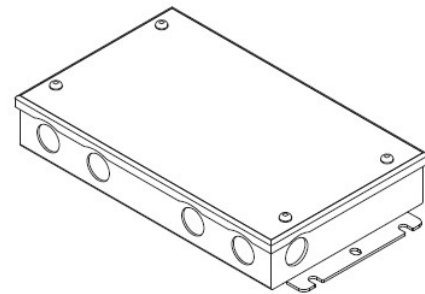

#### PSDE SERIES

0-10V DIMMING W/ JUNCTION BOX

PSDE-60W-24V-010-JB	CLASS 2	12.1" X 2.36" X 1.4"
---------------------	---------	----------------------

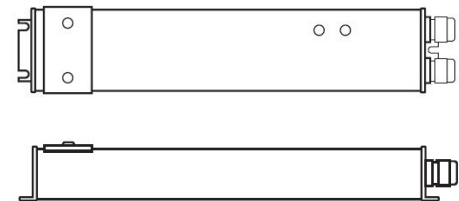

#### LUTRON 1%

2 OR 3-WIRE DIMMING

LTEA4U1UKL-CV240	CLASS 2	4.0" X 1.5" X 4.0"
L3DA4U1UKL-CV240	CLASS 2	4.0" X 1.5" X 4.0"

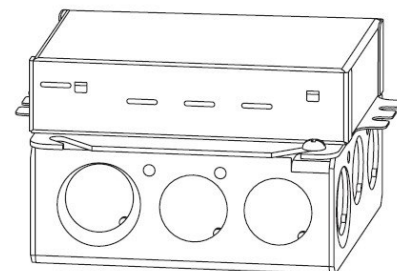

## INDOOR SUSPENDED LED LUMINAIRE

### COMPATIBLE TRANSFORMERS

---

LUTRON 1%

PSDE-96W-24V-ECO CLASS 2 10.5" X 3.0" X 2.0"

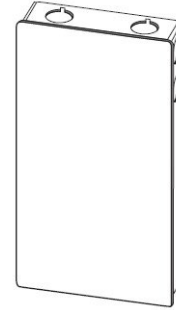

### COMPATIBLE NON-DIMMING DRIVERS

---

PSHK SERIES

NON-DIMMING CONSTANT VOLTAGE WITH JUNCTION BOX

PSHK-30W-24V	CLASS 2	6.5" X 3.6" X 1.02"
PSHK-60W-24V	CLASS 2	7.4" X 3.62" X 1.02"
PSHK-96W-24V	CLASS 2	8.66" X 3.66" X 1.61"
PSHK-150W-24V		10.24" X 4.06" X 1.81"
PSHK-200W-24V		10.24" X 4.06" X 1.81"
PSHK-288W-24V	CLASS 2	11.85" X 4.25" X 1.82"
PSHK-300W-24V		10.24" X 4.25" X 1.81"

