

LSM90HF

7.9W High-Output Indoor Flexible LED Strip

JOB NAME: _____
LOCATION: _____
QUOTE/REF#: _____

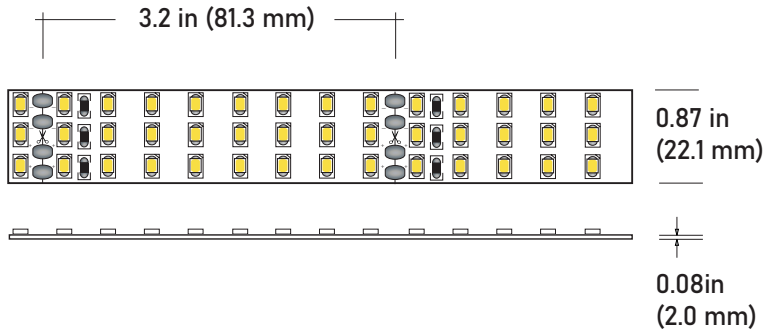

LSM90HF high output LED strip is designed to produce more than 930 lumens at 7.9 Watts per foot. These field cuttable LED strips are offered in a low profile design that can be attached almost anywhere and are great for many common lighting applications, such as cove lighting or cabinets. LSM90HF series produces a 120° light beam spread and is offered in different color temperatures to fit your specific needs. UL listed.





SPECIFICATIONS

INPUT VOLTAGE	24V DC
POWER CONSUMPTION	7.9W per foot
LUMEN OUTPUT	930 Lumens per foot
NO. OF LEDs	96 LEDs per foot
BEAM ANGLE	120°
CRI	90+
DIMMING	MLV, ELV, 0-10V and TRIAC
MAXIMUM RUN LENGTH	20 Feet
FIELD CUTTABLE	Every 3.2 in (81.3MM)
IP RATING	IP45 dry location (indoor)
LUMEN MAINTENANCE	50,000 hrs.
OPERATING TEMPERATURE	-40°F(-40°C)~+140°F(+60°C)
BINNING	1.5 Step Macadam Elipse
CERTIFICATIONS	UL listed
DIMENSIONS	0.87" x 0.08 (width x height)

FEATURES

- 7.9W per Foot
- 930 Lumens
- 90+ CRI
- Three rows of high-output diodes
- 20 Feet Maximum Run Length
- Field cuttable
- Ideal for accent and ambient lighting
- Multiple CCT options available
- UL Listed, Title 24 JA8 compliant
- Dimmable with CORE dimmable drivers
- Approved for closet / storage space installation per NEC 410.16(A)(3) and 410.16(C)(5)

	COLOR TEMP	CRI	LUMEN/FT
--	------------	-----	----------

	2700K	95	866
	3000K	95	930
	3500K	95	954
	4000K	95	988
	5000K	95	1032



LSM90HF

7.9W High-Output Indoor Flexible LED Strip

STANDARD ORDERING CODE

Model	Color Temp	Length	Voltage	Profile
LSM90HF	27K 2700K	16 16.4 Ft.	24 24 Volts	² See p3
	30K 3000K	100 100 Ft.		
	35K 3500K	¹ XX per Ft.		
	40K 4000K			
	50K 5000K			

NOTE:

- 1** = Custom length per Ft. cuttable every 3.2"
- 2** = Custom color finishes require powder coating. Allow 7 days lead time.

LSM90HF

7.9W High-Output Indoor Flexible LED Strip

COMPATIBLE ALUMINUM PROFILES

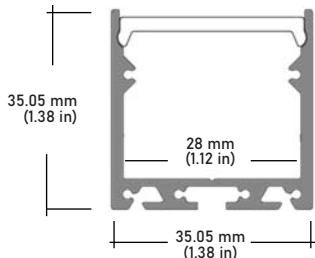

ALP-140 Surface, Suspended
LENGTHS 49.25" | 98.5"
LENS Frosted
FINISH Silver

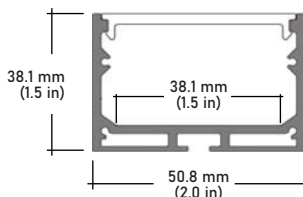

ALP-160 Surface, Suspended
LENGTHS 49.25" | 98.5"
LENS Frosted
FINISH Silver

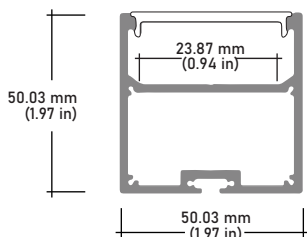

ALP-200 Surface, Suspended
LENGTHS 49.25" | 98.5"
LENS Frosted
FINISH Silver

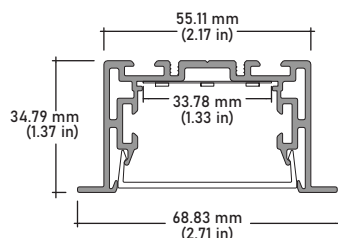

ALP-230RN Recessed
LENGTHS 49.25" | 98.5"
LENS Frosted
FINISH Silver

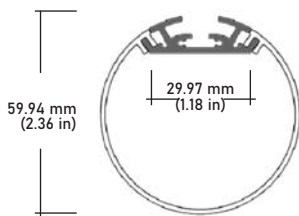

ALP-245 Suspended
LENGTHS 49.25" | 98.5"
LENS Frosted
FINISH Silver

LSM90HF

7.9W High-Output Indoor Flexible LED Strip

COMPATIBLE TRANSFORMERS

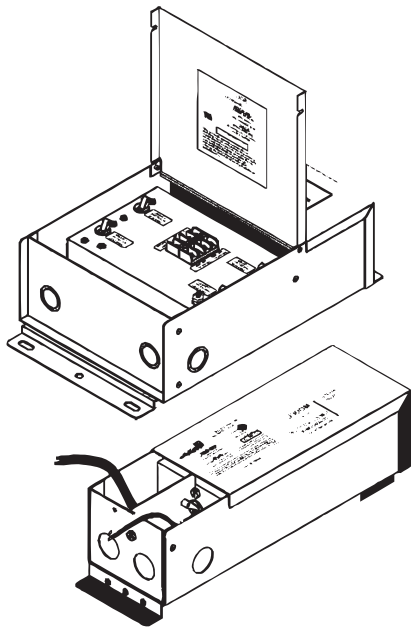

PSDH SERIES | HIGH PERFORMANCE MAGNETIC LOW VOLTAGE (MLV)

PSDH-48W-24V	CLASS 2	11.25"x 3.37"x 3.25"
PSDH-96W-24V	CLASS 2	11.25"x 3.37"x 3.25"
PSDH-288W-24V	CLASS 2	14.25"x 8.43"x 4.43"

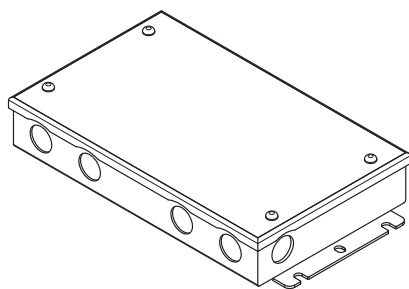

PSDL SERIES | TRIAC DIMMABLE

PSDL-30W-24V	CLASS 2	6.5"x 3.63"x 1.03"
PSDL-60W-24V	CLASS 2	7.4"x 3.63"x 1.03"
PSDL-96W-24V	CLASS 2	8.67"x 3.67"x 1.62"
PSDL-150W-24V		8.67"x 3.67"x 1.62"
PSDL-192W-24V	CLASS 2	10.25"x 4.06"x 1.82"
PSDL-200W-24V		10.25"x 4.06"x 1.82"
PSDL-288W-24V	CLASS 2	10.25"x 4.06"x 1.82"
PSDL-300W-24V		10.25"x 4.06"x 1.82"

LSM90HF

7.9W High-Output Indoor Flexible LED Strip

COMPATIBLE TRANSFORMERS

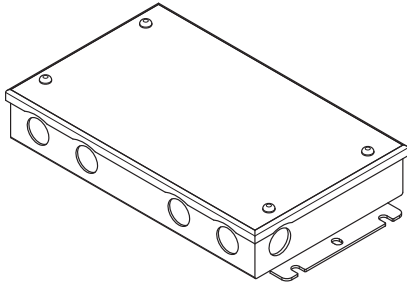

PSHK SERIES | NON-DIMMING W/ JUNCTION BOX

PSHK-30W-24V-UNV	CLASS 2	6.5" X 3.6" X 1.02"
PSHK-60W-24V-UNV	CLASS 2	7.4" X 3.62" X 1.02"
PSHK-96W-24V-UNV	CLASS 2	8.66" X 3.66" X 1.61"
PSHK-150W-24V-UNV		10.24" X 4.06" X 1.81"
PSHK-200W-24V-UNV		10.24" X 4.06" X 1.81"
PSHK-300W-24V-UNV		10.94" X 4.25" X 1.81"



PSDE SERIES | 0-10V DIMMING W/ JUNCTION BOX

PSDE-100W-24V-010-JB	CLASS 2	12.32" x 1.77" x 1.67"
-----------------------------	---------	------------------------



LSM90HF

7.9W High-Output Indoor Flexible LED Strip

COMPATIBLE TRANSFORMERS

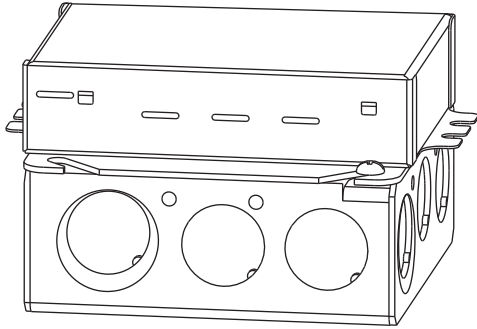

LUTRON 1% | 2 OR 3-WIRE DIMMING

LTEA4U1UKL-CV240

CLASS 2

4.0" x 1.5" x 4.0"

L3DA4U1UKL-CV240

CLASS 2

4.0" x 1.5" x 4.0"

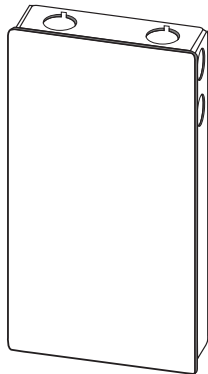

LUTRON 1%

PSDE-96W-24V-ECO

CLASS 2

10.5" x 3.0" x 2.0"