

# LSM-70HF

## 6.6W HIGH-OUTPUT INDOOR FLEXIBLE LED STRIP

Project \_\_\_\_\_

Location \_\_\_\_\_

Quote/ Ref # \_\_\_\_\_

**LSM-70HF** high output LED strip is designed to produce up to 858 Lumens at 6.6 Watts per Foot. This field cuttable LED strip features a low profile design that allows it to be attached almost anywhere. Installation is quick and easy. It produces a 120° light beam spread and is available in different color temperatures to fit your specific requirements.



### SPECIFICATIONS

INPUT VOLTAGE	24V DC
POWER CONSUMPTION	6.6W per Ft.
LUMEN OUTPUT	130 Lumens per Watt
NO. OF LEDS	72 LEDs per Ft.
BEAM ANGLE	120°
CRI	90+
DIMMING/ CONTROL	MLV, ELV, 0-10 and TRIAC
MAXIMUM RUN LENGTH	20 Ft.
FIELD CUTTABLE	Every 1.38 in
IP RATING	IP45 dry location (Indoor)
LUMEN MAINTENANCE	50,000 Hrs.
OPERATING TEMPERATURE	-40°F (-40°C) ~ +140°F (+60°C)
BINNING	1.5 Step Macadam Elipse
CERTIFICATIONS	UL Listed, TITLE 24 JA8
DIMENSIONS	0.55" x 0.08" (14mm x 2mm) (WxH)

### FEATURES

- 6.6W per Ft
- 130 Lm/W
- 90+ CRI
- Field Cuttable
- Two rows of Powerful High Output diodes
- 20 Ft. Max Run Length
- Ideal for accent and ambient lighting
- UL listed
- Dimmable with CORE dimmable Drivers
- Approved for closet / storage space installation per NEC 410.16(A)(3) and 410.16(C)(5)



MODEL	COLOR TEMP	LENGTH	VOLTAGE	PROFILE
LSM-70HF	<b>27K</b> 2700K	<b>16</b> 16.4 Ft.	<b>24</b> 24 Volts	<sup>2</sup> See Page 3 for compatible profiles.
	<b>30K</b> 3000K	<b>100</b> 100 Ft.		
	<b>35K</b> 3500K	<b>1XX</b> per Ft.		
	<b>40K</b> 4000K			
	<b>50K</b> 5000K			
	<b>60K</b> 6000K			
		*1 = Custom length per FT. (Cuttable every 1.375 in.)		*Custom color finishes require powder coating. Allow 7 days leads time.

# LSM-70HF

## 6.6W HIGH-OUTPUT INDOOR FLEXIBLE LED STRIP

### DIMENSIONS

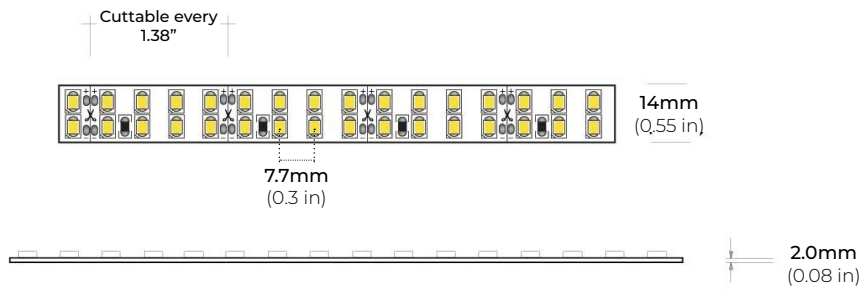

### LUMENS

MODEL	WATT	CCT	Lumen/ FT	CRI
LSM-70HF	6.6W	2700K	698	98
		3000K	718	98
		3500K	754	97
		4000K	835	96
		5000K	858	95
		6000K	772	90

# LSM-70HF

## 6.6W HIGH-OUTPUT INDOOR FLEXIBLE LED STRIP

### COMPATIBLE ALUMINUM PROFILES

#### SURFACE PROFILES

##### ALU-DS100

LENGTHS 39 $\frac{3}{8}$ " | 78 $\frac{7}{8}$ " | 84"  
LENS Clear, Frosted  
FINISH Silver

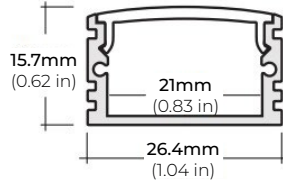

##### ALU-CN (CORNER)

LENGTHS 39 $\frac{3}{8}$ " | 78 $\frac{7}{8}$ " | 84" | 96"  
LENS Clear, Frosted  
FINISH Black | Silver

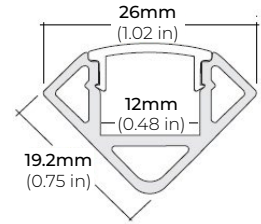

##### ALP-50C (CORNER)

LENGTHS 49.25" | 98.58" | 96"  
LENS Frosted  
FINISH White | Black | Silver

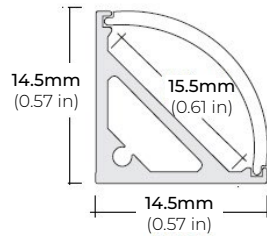

##### ALP-70

LENGTHS 49.25" | 84" | 98.5"  
LENS Frosted  
FINISH White | Black | Silver

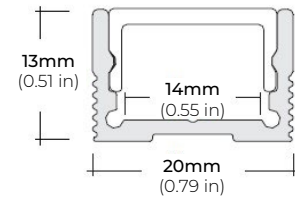

##### ALP-80

LENGTHS 49.25" | 98.5"  
LENS Frosted  
FINISH Silver

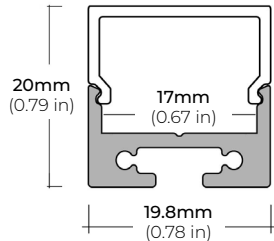

##### ALP-90

LENGTHS 49.25" | 98.5"  
LENS Frosted  
FINISH White | Black | Silver

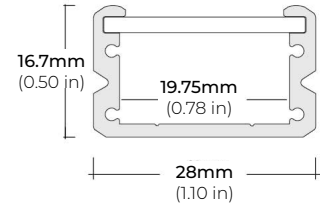

##### ALP-130

LENGTHS 49.25" | 84" | 98.5"  
LENS Frosted  
FINISH Silver

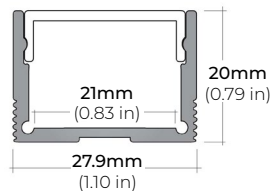

##### ALP-140

LENGTHS 49.25" | 98.5"  
LENS Frosted  
FINISH Silver

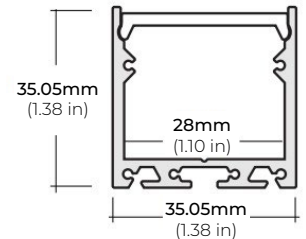

\* For more compatible profiles, visit [corelightingusa.com](http://corelightingusa.com)

# LSM-70HF

## 6.6W HIGH-OUTPUT INDOOR FLEXIBLE LED STRIP

### COMPATIBLE TRANSFORMERS

#### PSDL SERIES TRIAC DIMMABLE

PSDL-30W-24V	CLASS 2	6.5" X 3.63" X 1.03"
PSDL-60W-24V	CLASS 2	7.4" X 3.63" X 1.03"
PSDL-96W-24V	CLASS 2	8.67" X 3.67" X 1.62"
PSDL-150W-24V		8.67" X 3.67" X 1.62"
PSDL-192W-24V	CLASS 2	10.25" X 4.06" X 1.82"
PSDL-200W-24V		10.25" X 4.06" X 1.82"
PSDL-288W-24V	CLASS 2	10.25" X 4.06" X 1.82"
PSDL-300W-24V		10.25" X 4.06" X 1.82"

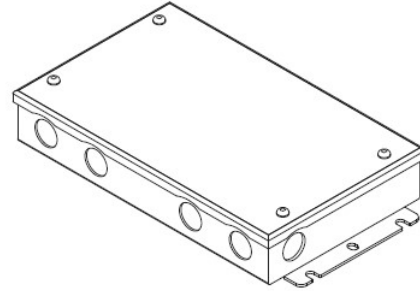

#### PSDH SERIES HIGH PERFORMANCE MAGNETIC LOW VOLTAGE (MLV)

PSDH-48W-24V	CLASS 2	11.25" X 3.37" X 3.25"
PSDH-96W-24V	CLASS 2	11.25" X 3.37" X 3.25"
PSDH-288W-24V	CLASS 2	14.25" X 8.43" X 4.43"

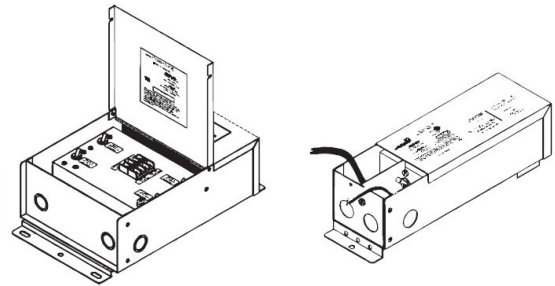

#### PSRX SERIES 4-IN-1 DIMMING DRIVER

PSRX-30W-24V	CLASS 2	6.5" X 3.72" X 1.57"
PSRX-60W-24V	CLASS 2	7.4" X 3.72" X 1.57"
PSRX-96W-24V	CLASS 2	8.66" X 3.72" X 1.57"
PSRX-150W-24V		10.24" X 4.13" X 1.77"
PSRX-200W-24V		10.24" X 4.13" X 1.77"
PSRX-300W-24V		10.94" X 4.33" X 1.77"

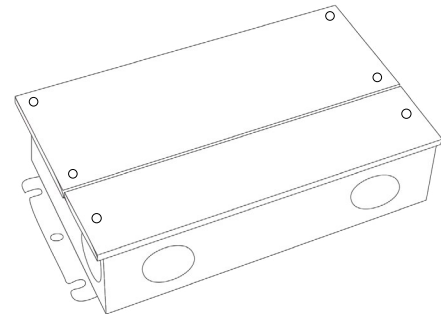

#### PSVT SERIES 4-IN-1 DIMMING DRIVER

PSVT-60W-24V	CLASS 2	7.4" X 3.72" X 1.57"
PSVT-96W-24V	CLASS 2	8.66" X 3.72" X 1.57"
PSVT-200W-24V		10.24" X 4.13" X 1.77"
PSVT-288W-24V	CLASS 2	11.85" X 4.25" X 1.81"
PSVT-300W-24V		10.94" X 4.33" X 1.77"

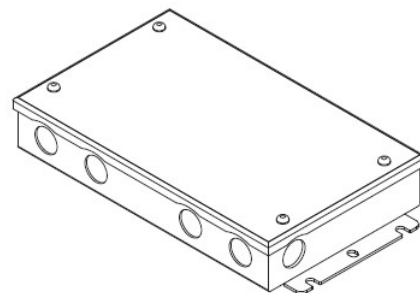

# LSM-70HF

## 6.6W HIGH-OUTPUT INDOOR FLEXIBLE LED STRIP

### COMPATIBLE TRANSFORMERS

#### PSDE SERIES

0-10V DIMMING W/ JUNCTION BOX

PSDE-60W-24V-010-JB	CLASS 2	12.1" X 2.36" X 1.4"
PSDE-96W-24V-010-JB	CLASS 2	12.1" X 2.36" X 1.4"

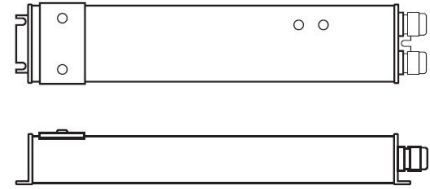

#### LUTRON 1%

2 OR 3-WIRE DIMMING

LTEA4U1UKL-CV240	CLASS 2	4.89" X 4" X 2.62"
L3DA4U1UKL-CV240	CLASS 2	4.89" X 4" X 2.62"

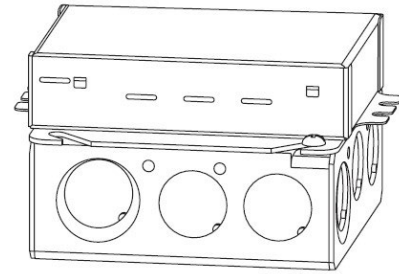

#### LUTRON 1%

PSDE-96W-24V-ECO	CLASS 2	10.5" X 3.0" X 2.0"
------------------	---------	---------------------

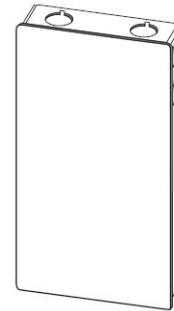

### COMPATIBLE NON-DIMMING DRIVERS

#### PSHK SERIES

NON-DIMMING CONSTANT VOLTAGE WITH JUNCTION BOX

PSHK-30W-24V	CLASS 2	6.5" X 3.6" X 1.02"
PSHK-60W-24V	CLASS 2	7.4" X 3.62" X 1.02"
PSHK-96W-24V	CLASS 2	8.66" X 3.66" X 1.61"
PSHK-150W-24V		10.24" X 4.06" X 1.81"
PSHK-200W-24V		10.24" X 4.06" X 1.81"
PSHK-288W-24V	CLASS 2	11.85" X 4.25" X 1.82"
PSHK-300W-24V		10.24" X 4.25" X 1.81"

