

ALP-4300KN

KNIFE-EDGE LED PROFILE SYSTEM

Project _____
Location _____
Quote/ Ref # _____

The **ALP-4300KN** (Knife Edge LED System) produces a seamless, elegant and visually striking, sharp-edged architectural feature that produces even light distribution and uniform lighting. It attaches to heavy gauge steel wall brackets or special extension. It accepts 1/2" or 5/8" thick drywall on its underside.



SPECIFICATIONS

LED STRIP	Fits LED strips up to 24mm (0.94 in)
WATTAGE	3W/ 4.4W/ 6.6W
LUMEN OUTPUT	210lm/ 315 Lm/ 698 Lm
LENS	Frosted (Included)
LENGTH OPTIONS	84 In.
CRI	95+
COLOR TEMPERATURE	27K/ 30K/ 35K/ 40K/ 50K
DIMMING	MLV, ELV, 0-10, TRIAC and DMX
CONNECTIONS	End to End In-Field
OPERATING TEMPERATURE	-40°C (-40°F) to 50°C (122°F)
RATING	IP54 Indoor
CERTIFICATIONS	UL Listed

FEATURES

- Fits LED strips up to 24mm (0.94 in) wide
- Frosted lens included with each profile
- Factory cut to length
- Field Cuttable
- Factory built precision inside and outside corners
- Painted eggshell RAL 9010
- Primer to accept field painting



MODEL	LENGTH	LIGHT OUTPUT	COLOR TEMP	FINISH	LENS	VOLTAGE	DRIVER
ALP4300KN	84 84 In.	L1 3 Watts	27K 2700K	WH White	FR Frosted	24 24 Volts	EB PSDL Series TRIAC ELV Dimming
	XX Custom Length	L2 4.4 Watts	30K 3000K	CC Custom Color			D10 PSDE-96W-24-010JB 0-10V Dimming
		L3 6.6 Watts	35K 3500K				HL2W Lutron 2-Wire
			40K 4000K				HL3E Lutron ECO 3-Wire
			50K 5000K				

* Custom color finishes require powder coating. Allow 7 days lead time.

ALP-4300KN

KNIFE-EDGE LED PROFILE SYSTEM

DIMENSIONS

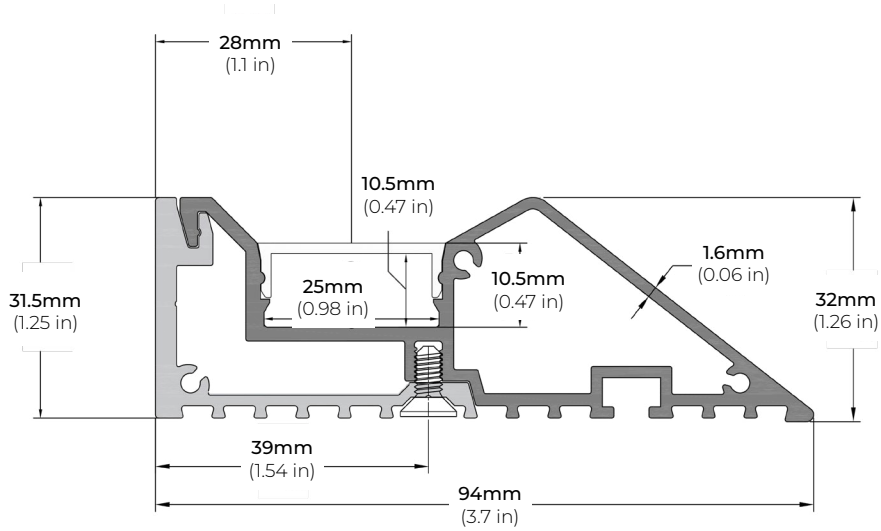

LUMENS

MODEL	TYPE	Lumen/ FT	WATTS
ALP-4300KN	L1	210 LM/ FT.	3W
	L2	315 LM/ FT.	4.4W
	L3	698 LM/ FT.	6.6W

ACCESSORIES

ALP4300KN-STB
STRAIGHT CONNECTOR

* Sold separately

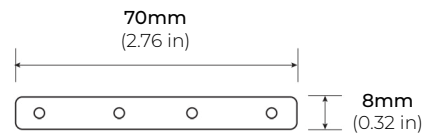

ALP4300KN-L90
INSIDE CORNER

* Sold separately



ALP-4300KN

KNIFE-EDGE LED PROFILE SYSTEM

ACCESSORIES

ALP4300KN-L90W
OUTSIDE CORNER

* Sold separately



ALP4300KN-EC
END CAP

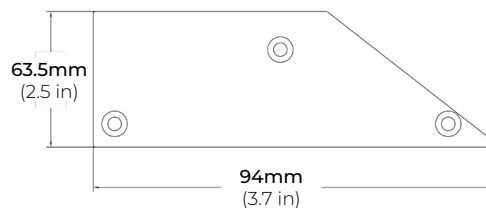

ALP-4300KN

KNIFE-EDGE LED PROFILE SYSTEM

COMPATIBLE TRANSFORMERS

PSDL SERIES TRIAC DIMMABLE

PSDL-30W-24V	CLASS 2	6.5" X 3.63" X 1.03"
PSDL-60W-24V	CLASS 2	7.4" X 3.63" X 1.03"
PSDL-96W-24V	CLASS 2	8.67" X 3.67" X 1.62"
PSDL-150W-24V		8.67" X 3.67" X 1.62"
PSDL-192W-24V	CLASS 2	10.25" X 4.06" X 1.82"
PSDL-200W-24V		10.25" X 4.06" X 1.82"
PSDL-288W-24V	CLASS 2	10.25" X 4.06" X 1.82"
PSDL-300W-24V		10.25" X 4.06" X 1.82"

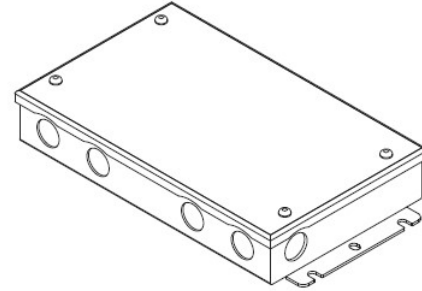

PSDE SERIES 0-10V DIMMING W/ JUNCTION BOX

PSDE-60W-24V-010-JB	CLASS 2	12.1" X 2.36" X 1.4"
---------------------	---------	----------------------

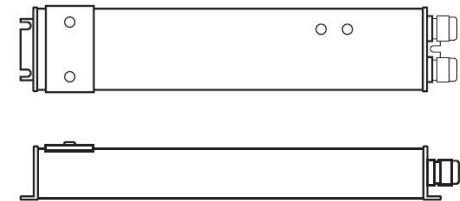

LUTRON 1% 2 OR 3-WIRE DIMMING

LTEA4U1UKL-CV240	CLASS 2	4.0" X 1.5" X 4.0"
L3DA4U1UKL-CV240	CLASS 2	4.0" X 1.5" X 4.0"

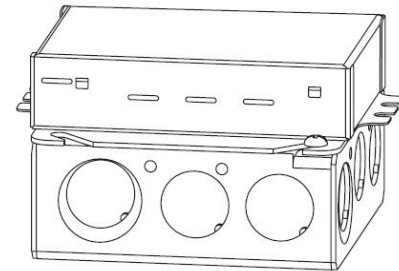

LUTRON 1%

PSDE-96W-24V-ECO	CLASS 2	10.5" X 3.0" X 2.0"
------------------	---------	---------------------

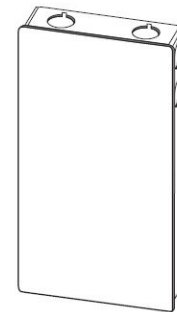

ALP-4300KN

KNIFE-EDGE LED PROFILE SYSTEM

COMPATIBLE NON-DIMMING DRIVERS

PSHK SERIES

NON-DIMMING CONSTANT VOLTAGE WITH JUNCTION BOX

PSHK-30W-24V	CLASS 2	6.5" X 3.6" X 1.02"
PSHK-60W-24V	CLASS 2	7.4" X 3.62" X 1.02"
PSHK-96W-24V	CLASS 2	8.66" X 3.66" X 1.61"
PSHK-150W-24V		10.24" X 4.06" X 1.81"
PSHK-200W-24V		10.24" X 4.06" X 1.81"
PSHK-288W-24V	CLASS 2	11.85" X 4.25" X 1.82"
PSHK-300W-24V		10.24" X 4.25" X 1.81"

