

## INSTALLATION

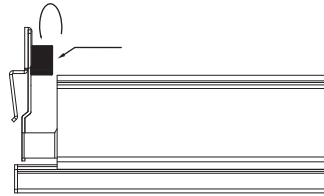

1. This product is intended to be installed by an experienced technician/electrician.
2. Make sure to **TURN OFF MAIN POWER** prior to installation of any electrical device.
3. This product is designed for **INDOOR** use.

1. Unlock the two nuts at the end of the fixture



2. Attach to ceiling grid.

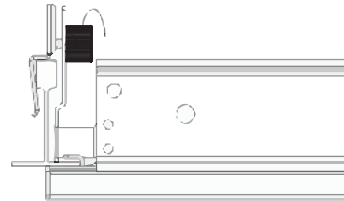

3. Tighten terminal nuts to secure fixture in place.

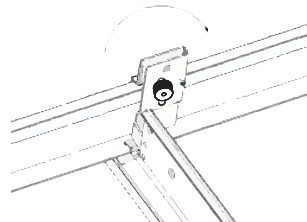

4. Unlock nuts from junction box ends.

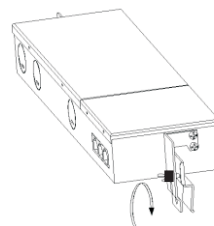

- 5 Secure junction box to fixture and tighten the two terminal nuts to fasten fixture onto ceiling grid.

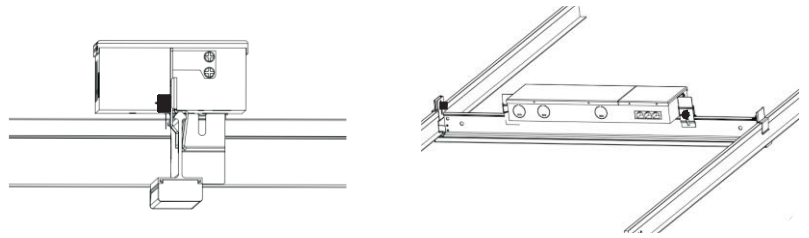

- 6 Connect RJ45 connectors from LED light fixture to the output terminal connector of junction box.



## CSL100 T-GRID SYSTEM WIRING DIAGRAM

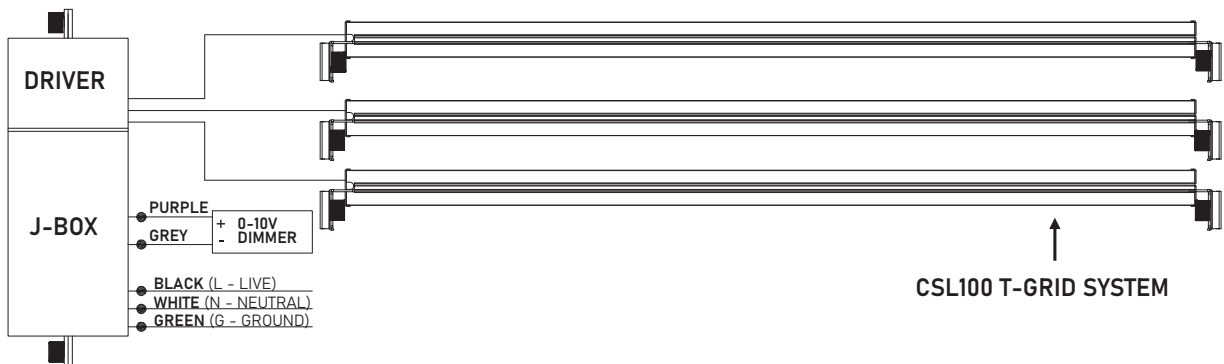

- 7 Open junction box and connect Live, Neutral and Ground wires using the 4-pin connectors and connect the dimming wire with the orange connector cap.



- 8 Cover plasterboard to finish installation and make sure ceiling is secured shut with no opening around fixture.

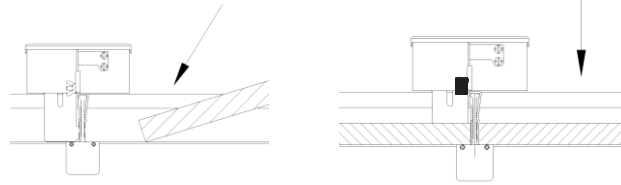

# INSTALLATION



SHAPE



SHAPE



SHAPE

Based on your required shape design requirement, remove the T-GRID from the drop ceiling accordingly.

 - Remove grids: #1, #2, #3, #4, #5 and #6



- Remove grids: #5, #6, #7 and #8



- Remove grids: #5, #6, #7 and #8

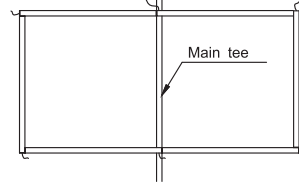
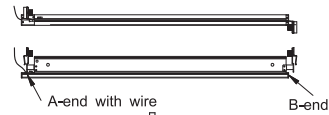
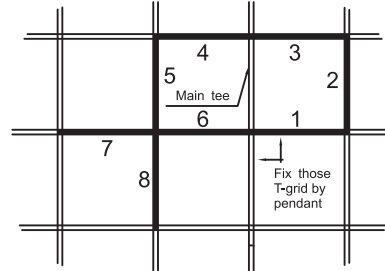

## Installation steps

- 1) #1 light fixture - fix the A-end with the wire of the #1 light fixture by pendant and the B-end on the "a" T-Grid.
- 2) Fix the #2 light fixture on the #1 light fixture with the A-end with wire, and the B-end on the "b" T-grid.
- 3) Fix the #3 light fixture on the #2 light fixture with the A-end with wire and the B-end on the "d" T-grid.
- 4) Fix the #4 light fixture on the "c" T-grid with the A-end with wire, and the B-end on the "d" T-grid.
- 5) Fix the #5 light fixture on the #4 light fixture with the A-end with wire and the B-end on the "e" T-grid
- 6) Fix the #6 light fixture on the #5 light fixture with the A-end with wire and the B-end on the "c" T-grid.

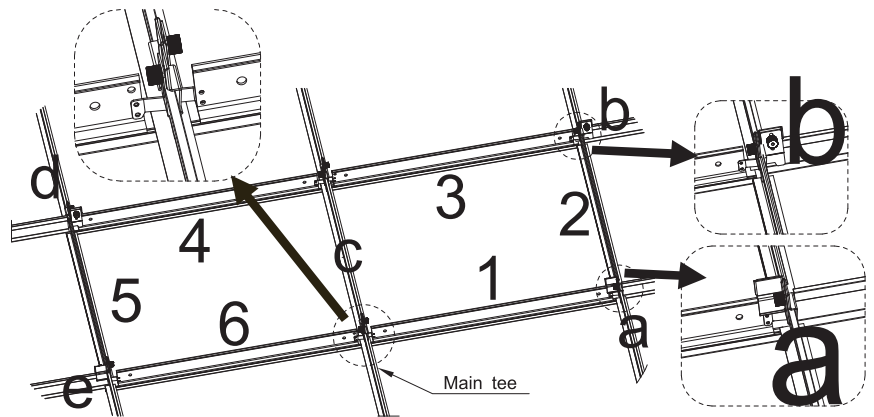

# INSTALLATION



## T Installation steps

- 1) Install #5 light fixture, fix the A-end with wire of the light fixture on the "d" T-grid and the B-end by pendant.
- 2) Fix the A-end with wire of the #6 light fixture on the #5 light fixture and the B-end of the fixture on the "e" T-grid. Using the same method, fix the A-end with wire of the #7 light fixture on the "g" T-grid and the B-end on the "f" T-grid.

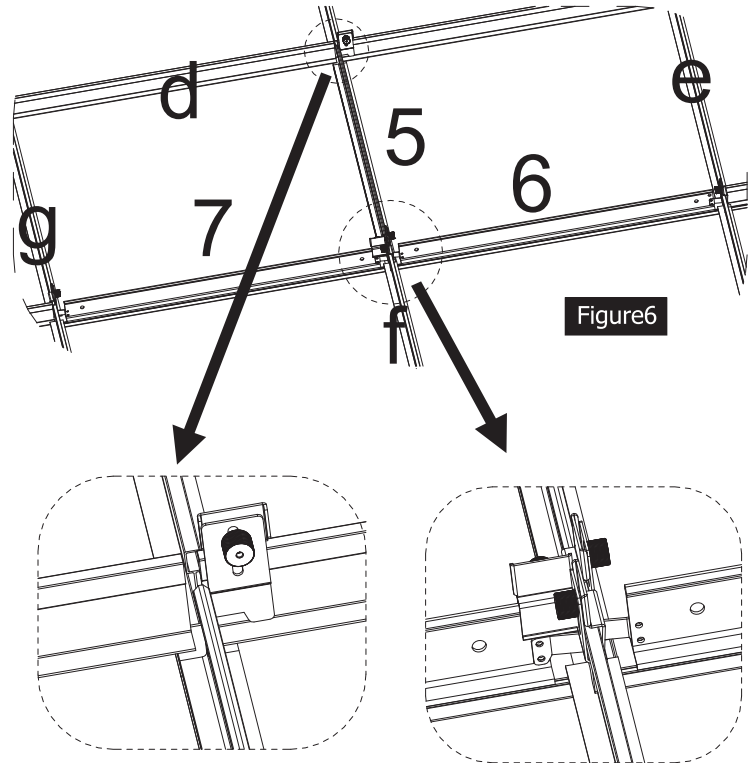

## + Installation steps

Follow T-shape installation steps above and replace the "f" T-grid with one light fixture.