

SPECIFICATION SHEET

JOB NAME: _____
 LOCATION: _____
 QUOTE/REF#: _____



LWW-HO Linear Wall washer series is a powerful LED flood light typically used for building facades, signs or any wall washing applications. Variety of optical lens options provides endless lighting solutions. Available in narrow, medium, wide and elliptical optic options.

FEATURES

- 110 Lumens per Watt
- Linkable up to 12ft.
- Proprietary Optical Technology
- TRIAC Dimming
- Proprietary Adjustable Mounting Bracket
- Facade Wall Washing
- Graze Lighting & Signage

SPECIFICATIONS

INPUT VOLTAGE	24V DC
POWER CONSUMPTION	9W per Ft.
LUMEN PER WATT	110 lm/W
BEAM ANGLE	15° / 20° / 35° / 50° / 10°x40° (A2)
CRI	90+
DIMMING	TRIAC
MAXIMUM RUN LENGTH	Linkable up to 12 Ft.
IP RATING	IP65 wet location (outdoor)
LUMEN MAINTENANCE	50,000 hrs.
OPERATING TEMPERATURE	-4°F(-20°C)~+122°F(+50°C)
OPERATING TEMPERATURE	-22°F(-30°C)~+176°F(+80°C)

	COLOR TEMP	CRI
	2200K	90+
	2700K	90+
	3000K	90+
	4000K	90+
	5000K	90+
	6000K	90+



THIS FIXTURE IS NOT COMPATIBLE WITH PSDH AND PSDM SERIES DRIVERS. DIMMING IS ONLY AVAILABLE WITH 0-10 DRIVERS

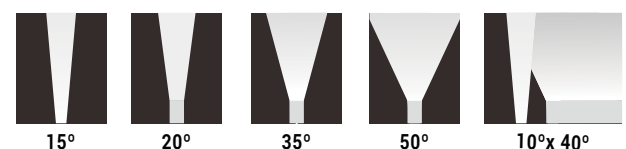

LWW-HO High Output Linear LED Wall Washer

ORDERING CODE

Model	Length	Color Temp	Optics	Mounting Option	Finish Option
LWW-HO	12 - 12" (9W)	22K - 2200K	15 - 15°	FMB Fixed Mounting Bracket	TG Titanium Gray
	20 - 20" (15W)	27K - 2700K	20 - 20°		
	24 - 24" (18W)	30K - 3000K	35 - 35°	STB Standard Tilting Bracket	*BK Black
	40 - 40" (30W)	40K - 4000K	50 - 50°		
	48 - 48" (36W)	50K - 5000K	10x40 - 10°x40°	ETB Extended Tilting Bracket	*WH White
		60K - 6000K			
		RD - RED			
		GN - GREEN			
		BL - BLUE			
		AM - AMBER			

* Allow 4 weeks lead time

DIMENSIONS

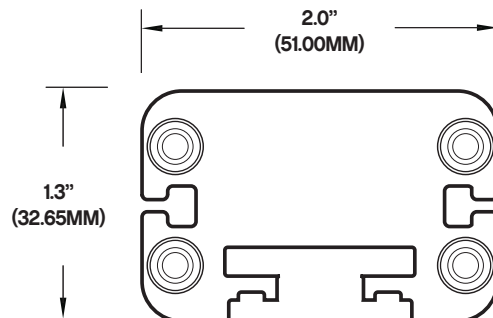

LWW-HO High Output Linear LED Wall Washer

COMPATIBLE ACCESORIES

LWW-HO-FMB | FIXED MOUNTING BRACKETS
(INCLUDED WITH FIXTURE)

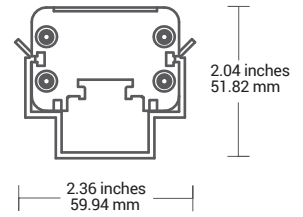

LWW-HO-STB | STANDARD TILTING BRACKET
(SOLD SEPARATELY)

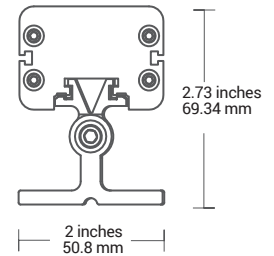

LWW-HO-ETB | EXTENDED TILTING BRACKET
(SOLD SEPARATELY)

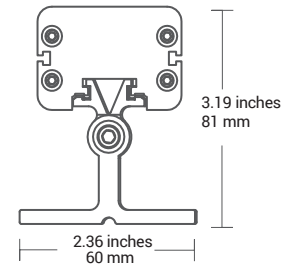

LWW-HO-12-SDLV | 12" Louver
LWW-HO-20-SDLV | 20" Louver
LWW-HO-24-SDLV | 24" Louver
LWW-HO-40-SDLV | 40" Louver
LWW-HO-48-SDLV | 48" Louver
(SOLD SEPARATELY)

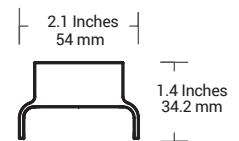

LWW-HO-12-ADLV | 12" Louver
LWW-HO-20-ADLV | 20" Louver
LWW-HO-24-ADLV | 24" Louver
LWW-HO-40-ADLV | 40" Louver
LWW-HO-48-ADLV | 48" Louver
(SOLD SEPARATELY)

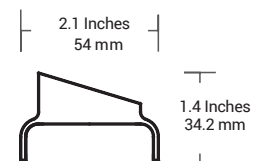
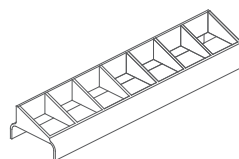

COMPATIBLE ACCESORIES

LWW-LNK-10 | 10" LINK CABLE
LWW-HW-36 | 36" LINK CABLE
LWW-HW-72 | 72" LINK CABLE



LWW-HWC-72-BK | 72" HARDWIRE CABLE



COMPATIBLE TRANSFORMERS



PSDL SERIES TRIAC DIMMABLE

PSDL-30W-24V	CLASS 2	6.5"x 3.63"x 1.03"
PSDL-60W-24V	CLASS 2	7.4"x 3.63"x 1.03"
PSDL-96W-24V	CLASS 2	8.67"x 3.67"x 1.62"
PSDL-150W-24V		8.67"x 3.67"x 1.62"
PSDL-192W-24V		10.25"x 4.06"x 1.82"
PSDL-200W-24V		10.25"x 4.06"x 1.82"
PSDL-288W-24V		10.25"x 4.06"x 1.82"
PSDL-300W-24V		10.25"x 4.06"x 1.82"



PSHK SERIES NON-DIMMING WITH JUNCTION BOX

PSHK-30W-24V-UNV	CLASS 2	6.5" X 3.6" X 1.02"
PSHK-60W-24V-UNV	CLASS 2	7.4" X 3.62" X 1.02"
PSHK-96W-24V-UNV	CLASS 2	8.66" X 3.66" X 1.61"
PSHK-150W-24V-UNV		10.24" X 4.06" X 1.81"
PSHK-200W-24V-UNV		10.24" X 4.06" X 1.81"
PSHK-300W-24V-UNV		10.94" X 4.25" X 1.81"

COMPATIBLE TRANSFORMERS



PSVT SERIES 0-10V DIMMING DRIVER WITH JUNCTION BOX

PSVT-60W-24V-UNV-010	CLASS 2	7.4" X 3.72" X 1.57"
PSVT-96W-24V-UNV-010	CLASS 2	8.66" X 3.72" X 1.57"
PSVT-200W-24V-UNV-010		10.24" X 4.13" X 1.77"
PSVT-288W-24V-UNV-010	CLASS 2	11.85" X 4.25" X 1.81"
PSVT-300W-24V-UNV-010		10.94" X 4.33" X 1.77"

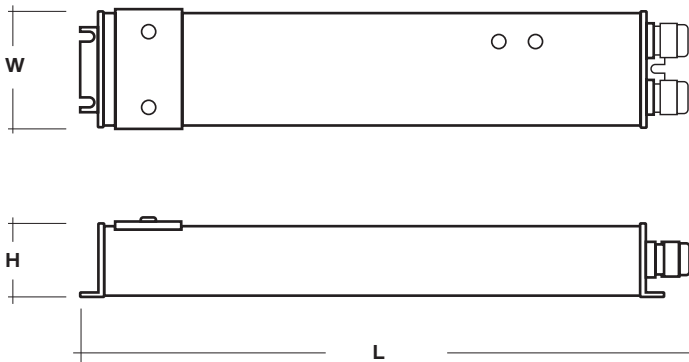

PSDE SERIES 0-10V DIMMING WITH JUNCTION BOX

PSDE-100W-24V-010-JB	CLASS 2	12.32" x 1.77" x 1.67"
-----------------------------	---------	------------------------