

LSM105

10W High Output Indoor Flexible LED Strip

JOB NAME: _____
LOCATION: _____
QUOTE/REF#: _____

1.0 in
(25.4 mm)

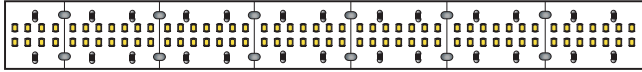

0.79 in
(20 mm)



0.04in
(1.1 mm)

LSM105 is a high-output, double-row LED strip designed to produce up to 840 Lm/Ft. at 10W/Ft. This field cuttable LED strip features a low profile design that allows it to be attached almost anywhere. Installation is quick and easy. It produces a 120° light beam spread and is available in different color temperatures to fit your specific needs.

SPECIFICATIONS

INPUT VOLTAGE	24V DC
POWER CONSUMPTION	10W per foot
LUMEN OUTPUT	840 Lm/Ft.
NO. OF LEDs	108 LEDs per foot
BEAM ANGLE	120°
CRI	98+
DIMMING	MLV, ELV, 0-10V and TRIAC
MAXIMUM RUN LENGTH	10 Feet
FIELD CUTTABLE	Every 1.0 in (25.4MM)
IP RATING	IP45 dry location (indoor)
LUMEN MAINTENANCE	50,000 hrs.
OPERATING TEMPERATURE	-40°F(-40°C)~+140°F(+60°C)
BINNING	1.5 Step Macadam Elipse
CERTIFICATIONS	UL listed
DIMENSIONS	0.79" x 0.04" (width x height)

FEATURES

- 10W per Foot
- 840 Lumens per Foot
- 98+ CRI
- Two rows of powerful high output diodes
- 10 Feet Maximum Run Length
- Ideal for accent and ambient lighting
- Multiple CCT options available
- UL Listed
- Dimmable with CORE dimmable drivers
- Approved for closet / storage space installation per NEC 410.16(A)(3) and 410.16(C)(5)

COLOR TEMP CRI LUMEN/FT



2200K	82	730
2500K	98	740
2700K	98	810
3000K	97	840
3500K	91	870
4000K	95	960



LSM105

10W High Output Indoor Flexible LED Strip

STANDARD ORDERING CODE

Model	Color Temp	Length	Voltage	Profile
LSM105	22K 2200K	16 16.4 Ft.	24 24 Volts	²See p3 for options
	25K 2500K	100 100 Ft.		
	27K 2700K	¹XX per Ft.		
	30K 3000K			
	35K 3500K			
	40K 4000K			

NOTE:

- 1** = Custom length per Ft. cuttable every 1.0"
- 2** = Custom color finishes require powder coating. Allow 7 days lead time.

LSM105

10W High Output Indoor Flexible LED Strip

COMPATIBLE ALUMINUM PROFILES

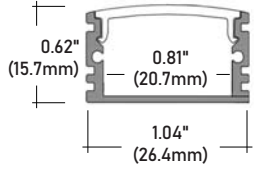

ALU-DS100 SURFACE MOUNT
LENGTHS 39 3/8" 78 7/8" 96"
LENS Clear and Frosted
FINISH Anodized Aluminum

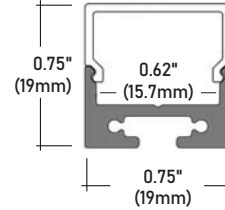

ALP-80 SURFACE OR SUSPENDED
LENGTHS 49.25" , 98.5"
LENS Frosted
FINISH Anodized Aluminum

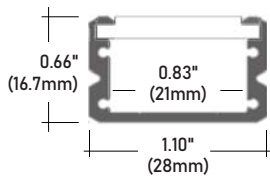

ALP-90 SURFACE MOUNT
LENGTHS 4Ft. / 8Ft. / per Ft.
LENS Frosted
FINISH Anodized Aluminum

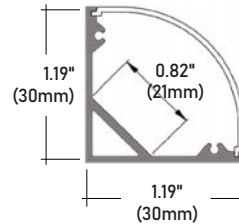

ALP-100C SURFACE / CORNER
LENGTHS 49.25" , 98.5"
LENS Frosted
FINISH Anodized Aluminum

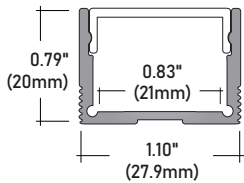

ALP-130 SURFACE
LENGTHS 49.25" , 98.5"
LENS Frosted
FINISH Anodized Aluminum

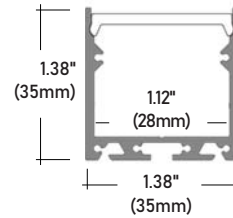

ALP-140 SURFACE / SUSPENSION
LENGTHS 49.25" , 98.5"
LENS Frosted
FINISH Anodized Aluminum

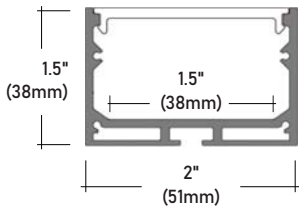

ALP-160 SURFACE / SUSPENDED
LENGTHS 49.25" and 98.5"
LENS Frosted
FINISH Anodized Aluminum

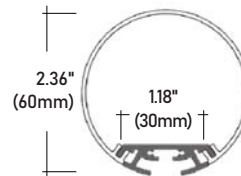

ALP-245 SUSPENSION MOUNT
LENGTHS 49.25" and 98.5"
LENS Frosted
FINISH Anodized Aluminum

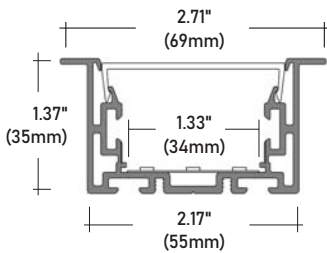

ALP-230RN RECESSED MOUNT
LENGTHS 49.25" and 98.5"
LENS Frosted
FINISH Anodized Aluminum

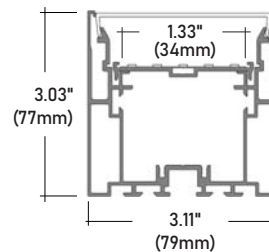

ALP-310N SUSPENSION MOUNT
LENGTHS 48" and 96"
LENS Frosted
FINISH Anodized Aluminum

LSM105

10W High Output Indoor Flexible LED Strip

COMPATIBLE TRANSFORMERS

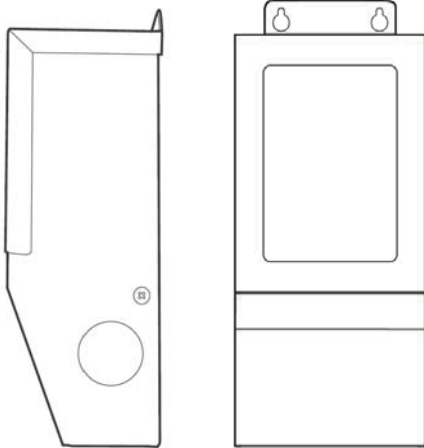

PSDM 24V SERIES | DIMMABLE MAGNETIC LOW VOLTAGE (MLV)

PSDM-20W-24V	CLASS 2	5.6" x 2" x 2.14"
PSDM-40W-24V	CLASS 2	5.6" x 2" x 2.14"
PSDM-60W-24V	CLASS 2	6.5" x 2.3" x 2.5"
PSDM-100W-24V	CLASS 2	6.5" x 2.3" x 2.5"
PSDM-150W-24V		9.8" x 3" x 3"
PSDM-192W-24V	CLASS 2	7.0" x 7.0" x 3.2"
PSDM-200W-24V		9.8" x 3" x 3"
PSDM-288W-24V	CLASS 2	9.8" x 4.2" x 3.5"
PSDM-300W-24V		7.0" x 7.0" x 3.2"

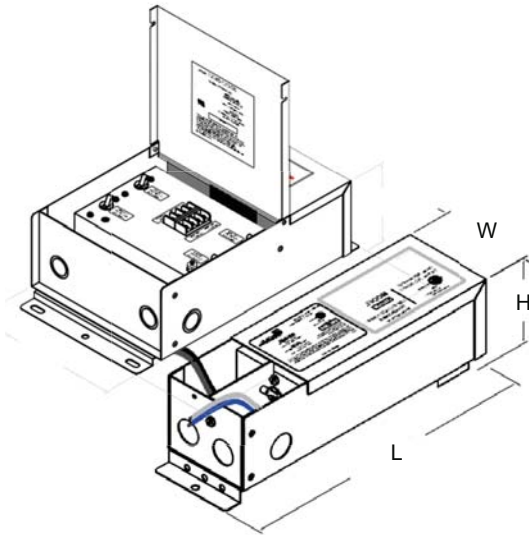

PSDH SERIES | HIGH PERFORMANCE MAGNETIC LOW VOLTAGE (MLV)

PSDH-48W-24V	CLASS 2	11.25" x 3.37" x 3.25"
PSDH-96W-24V	CLASS 2	11.25" x 3.37" x 3.25"
PSDH-288W-24V	CLASS 2	14.25" x 8.43" x 4.43"

LSM105

10W High Output Indoor Flexible LED Strip

COMPATIBLE TRANSFORMERS

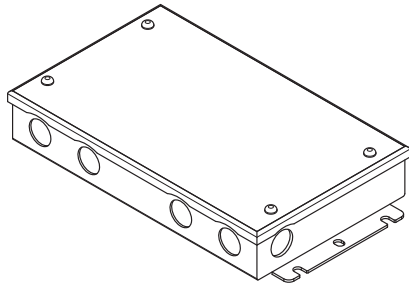

PSDL SERIES | TRIAC DIMMABLE

PSDL-30W-24V	CLASS 2	6.5"x 3.63"x 1.03"
PSDL-60W-24V	CLASS 2	7.4"x 3.63"x 1.03"
PSDL-96W-24V	CLASS 2	8.67"x 3.67"x 1.62"
PSDL-150W-24V	CLASS 2	8.67"x 3.67"x 1.62"
PSDL-192W-24V	CLASS 2	10.25"x 4.06"x 1.82"
PSDL-200W-24V	CLASS 2	10.25"x 4.06"x 1.82"
PSDL-288W-24V	CLASS 2	10.25"x 4.06"x 1.82"
PSDL-300W-24V	CLASS 2	10.25"x 4.06"x 1.82"

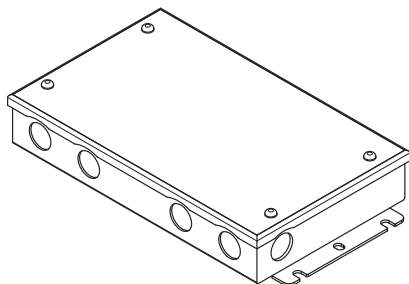

PSHK SERIES | NON-DIMMING W/ JUNCTION BOX

PSHK-30W-24V-UNV	CLASS 2	6.5" X 3.6" X 1.02"
PSHK-60W-24V-UNV	CLASS 2	7.4" X 3.62" X 1.02"
PSHK-96W-24V-UNV	CLASS 2	8.66" X 3.66" X 1.61"
PSHK-150W-24V-UNV	CLASS 2	10.24" X 4.06" X 1.81"
PSHK-200W-24V-UNV	CLASS 2	10.24" X 4.06" X 1.81"
PSHK-300W-24V-UNV	CLASS 2	10.94" X 4.25" X 1.81"

LSM105

10W High Output Indoor Flexible LED Strip

COMPATIBLE TRANSFORMERS



PSDE SERIES | 0-10V DIMMING W/ JUNCTION BOX

PSDE-100W-24V-010-JB CLASS 2 12.32" x 1.77" x 1.67"

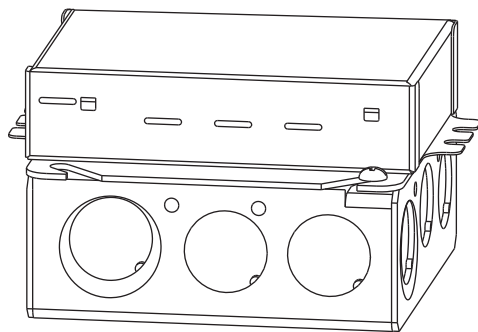

LUTRON 1% | 2 OR 3-WIRE DIMMING

LTEA4U1UKL-CV240 CLASS 2 4.0" x 1.5" x 4.0"

L3DA4U1UKL-CV240 CLASS 2 4.0" x 1.5" x 4.0"

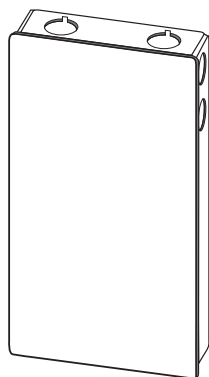

LUTRON 1%

PSDE-96W-24V-ECO CLASS 2 10.5" x 3.0" x 2.0"