

LSE-450 4.4W Indoor Eco Tape Light

SPECIFICATION SHEET

JOB NAME: _____
LOCATION: _____
QUOTE/REF#: _____

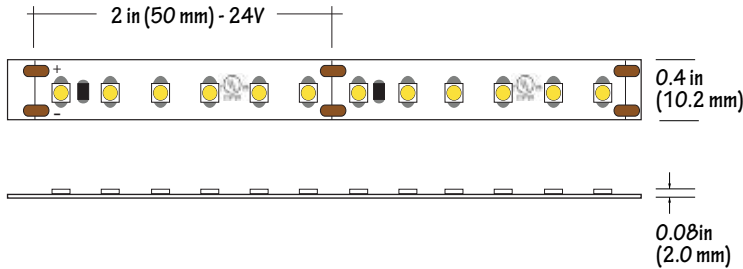



LSE-450 is a dimmable flexible LED strip capable of delivering 347 lumens of light output per ft. Its high lumen output, excellent color rendering and color temperature options make it the perfect choice for almost any commercial or residential lighting application.

FEATURES

- 4.4W per Foot
- 347 Lumens
- 90+ CRI
- Field cuttable
- Suitable for accent or ambient lighting
- Multiple CCT options available
- Available in 24V
- UL Listed
- Dimmable with CORE Lighting dimmable drivers

SPECIFICATIONS

INPUT VOLTAGE	24V DC
POWER CONSUMPTION	4.4W per foot
LUMEN OUTPUT	47 Lumens per foot
NO. OF LEDs	36 LEDs per foot
BEAM ANGLE	120°
CRI	90+
DIMMING	MLV, ELV, 0-10 and TRIAC
MAXIMUM RUN LENGTH	25 Feet
FIELD CUTTABLE	Every 2 in (50.8MM)
IP RATING	IP45 dry location (indoor)
LUMEN MAINTENANCE	35,000 hrs.
OPERATING TEMPERATURE	-40°F(-40°C)~+140°F(+60°C)
WARRANTY	3-YEAR LIMITED
CERTIFICATIONS	UL listed, TITLE 24 JA8
DIMENSIONS	0.4" x 0.08 (width x height)

	COLOR TEMP	CRI	LUMEN/FT
	2700K	90+	294
	3000K	90+	347
	4000K	90+	361



LSE-450 4.4W Indoor Eco Tape Light

STANDARD ORDERING CODE

Model	Color Temp	Length	Voltage
LSE-450	27K - 2700K 30K - 3000K 40K - 4000K	16 - 16.4 Ft. 100 - 100 Ft.	24V - 24V DC

COMPATIBLE ALUMINUM PROFILES

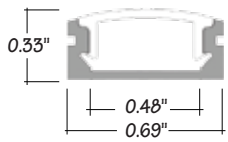

ALU-SF SURFACE MOUNT
LENGTHS 39^{3/8}" , 78^{7/8}" , 98"
LENS Clear , Frosted
FINISH Anodized Aluminum , Black

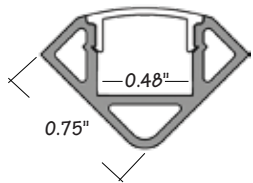

ALU-CN SURFACE / CORNER
LENGTHS 39^{3/8}" , 78^{7/8}" , 98"
LENS Clear , Frosted
FINISH Anodized Aluminum , Black

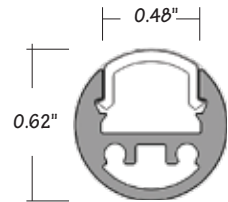

ALP-35 SURFACE MOUNT
LENGTHS 48" , 96"
LENS Frosted
FINISH Anodized Aluminum

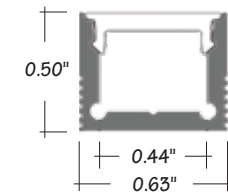

ALP-60 SURFACE MOUNT
LENGTHS 49.25" , 98.5"
LENS Frosted
FINISH White | Black | Silver

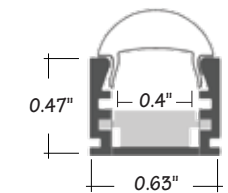

ALP-65 SURFACE MOUNT
LENGTHS 49.25" , 98.5"
LENS Frosted
FINISH Anodized Aluminum
OPTICS 10° , 30° and 60°

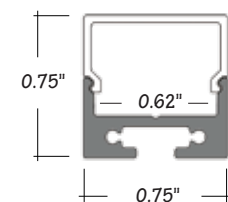

ALP-80 SURFACE OR SUSPENDED
LENGTHS 49.25" , 98.5"
LENS Frosted
FINISH Anodized Aluminum

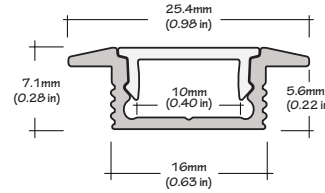

ALP-20R RECESSED MOUNT
LENGTHS 49.25" , 98.5"
LENS Frosted
FINISH White | Black | Silver

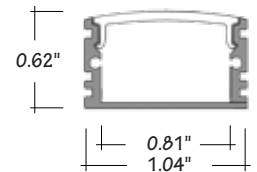

ALU-DS100 SURFACE MOUNT
LENGTHS 39^{3/8}" , 78^{7/8}"
LENS Clear and Frosted
FINISH Anodized Aluminum

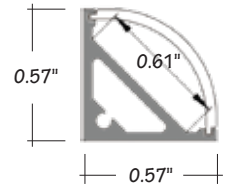

ALP-50C SURFACE / CORNER
LENGTHS 49.25" , 98.5"
LENS Frosted
FINISH White | Black | Silver



ALP-60R RECESSED MOUNT
LENGTHS 49.25" , 98.5"
LENS Frosted
FINISH White | Black | Silver

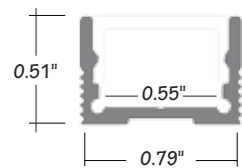

ALP-70 SURFACE MOUNT
LENGTHS 49.25" , 98.5"
LENS Frosted
FINISH White | Black | Silver

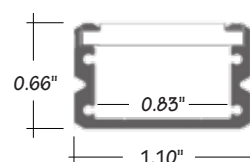

ALP-90 SURFACE MOUNT
LENGTHS 48" and 96"
LENS Frosted
FINISH Anodized Aluminum

COMPATIBLE ALUMINUM PROFILES

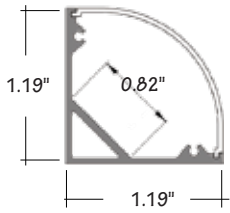

ALP-100C **SURFACE / CORNER**
LENGTHS 49.25" , 98.5"
LENS Frosted
FINISH Anodized Aluminum

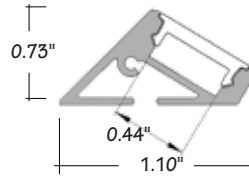

ALP-110 **SURFACE MOUNT**
LENGTHS 49.25" , 98.5"
LENS Frosted
FINISH Anodized Aluminum

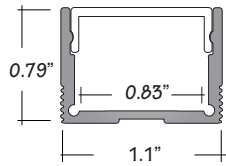

ALP-130 **SURFACE / SUSPENSION**
LENGTHS 49.25" , 98.5"
LENS Frosted
FINISH Anodized Aluminum

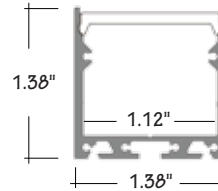

ALP-140 **SURFACE / SUSPENSION**
LENGTHS 49.25" , 98.5"
LENS Frosted
FINISH Anodized Aluminum

COMPATIBLE TRANSFORMERS

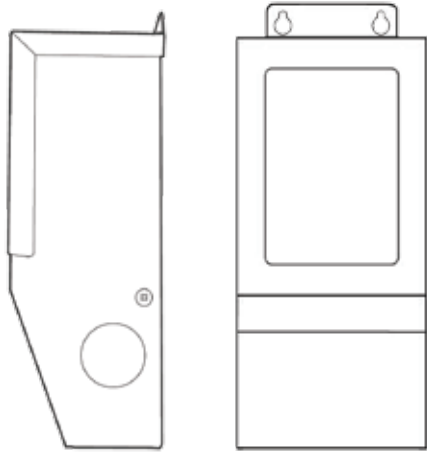

PSDM SERIES DIMMABLE MAGNETIC LOW VOLTAGE (MLV)

PSDM-20W-24V	CLASS 2	5.6" x 2" x 2.14"
PSDM-40W-24V	CLASS 2	5.6" x 2" x 2.14"
PSDM-60W-24V	CLASS 2	6.5" x 2.3" x 2.5"
PSDM-100W-24V	CLASS 2	6.5" x 2.3" x 2.5"
PSDM-150W-24V		9.8" x 3" x 3"
PSDM-192W-24V	CLASS 2	7.0" x 7.0" x 3.2"
PSDM-200W-24V		9.8" x 3" x 3"
PSDM-288W-24V	CLASS 2	9.8" x 4.2" x 3.5"
PSDM-300W-24V		7.0" x 7.0" x 3.2"

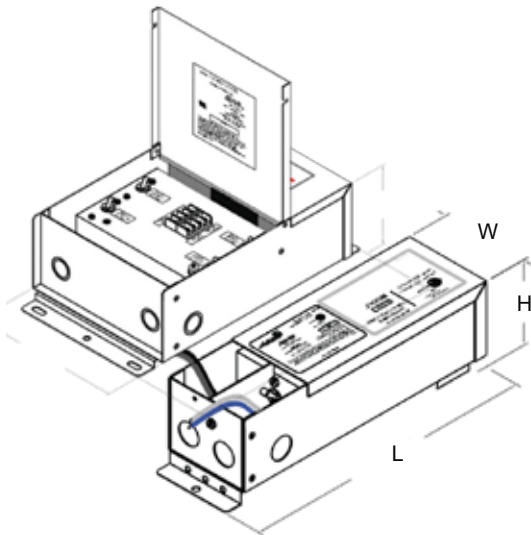

PSDH SERIES HIGH PERFORMANCE MLV

PSDH-48W-24V	CLASS 2	11.25" x 3.37" x 3.25"
PSDH-96W-24V	CLASS 2	11.25" x 3.37" x 3.25"
PSDH-288W-24V	CLASS 2	14.25" x 8.43" x 4.43"

COMPATIBLE TRANSFORMERS



PSDL SERIES TRIAC DIMMABLE

PSDL-30W-24V	CLASS 2	6.5"x 3.63"x 1.03"
PSDL-60W-24V	CLASS 2	7.4"x 3.63"x 1.03"
PSDL-96W-24V	CLASS 2	8.67"x 3.67"x 1.62"
PSDL-150W-24V		8.67"x 3.67"x 1.62"
PSDL-192W-24V		10.25"x 4.06"x 1.82"
PSDL-200W-24V		10.25"x 4.06"x 1.82"
PSDL-288W-24V		10.25"x 4.06"x 1.82"
PSDL-300W-24V		10.25"x 4.06"x 1.82"



PSHK SERIES NON-DIMMING WITH JUNCTION BOX

PSHK-30W-24V-UNV	CLASS 2	6.5" X 3.6" X 1.02"
PSHK-60W-24V-UNV	CLASS 2	7.4" X 3.62" X 1.02"
PSHK-96W-24V-UNV	CLASS 2	8.66" X 3.66" X 1.61"
PSHK-150W-24V-UNV		10.24" X 4.06" X 1.81"
PSHK-200W-24V-UNV		10.24" X 4.06" X 1.81"
PSHK-300W-24V-UNV		10.94" X 4.25" X 1.81"

LSE-450 4.4W Indoor Eco Tape Light

COMPATIBLE TRANSFORMERS

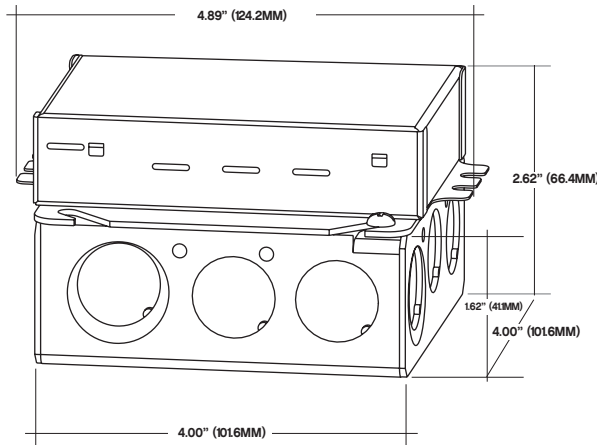
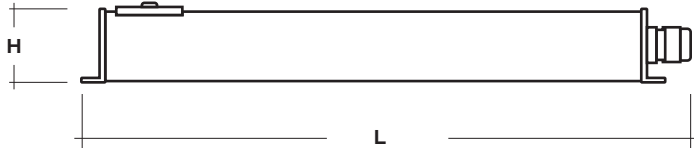

PSDE SERIES 0-10V DIMMING WITH JUNCTION BOX

PSDE-100W-24V-010-JB CLASS 2 12.32" x 1.77" x 1.67"

LUTRON 1% 2 OR 3-WIRE DIMMING

LTEA4U1UKL-CV240 CLASS 2 4.0" x 1.5" x 4.0"

L3DA4U1UKL-CV240 CLASS 2 4.0" x 1.5" x 4.0"

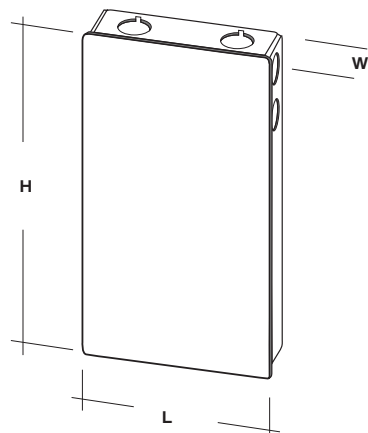

LUTRON 1%

PSDE-96W-24V-ECO CLASS 2 10.5" x 3.0" x 2.0"