

LSRN50 SERIES

4.4W IP65 Outdoor LED Strip



The LSRN series outdoor LED strip is a high-performance, water resistant light source designed for all-weather and harsh environments. It is manufactured with a patented epoxy PVC material that makes it resistant to salt water, chlorine, rain and humidity. Aside from its ability to withstand harsh environments, the LSRN series also does a great job of giving a space a much needed visual upgrade by providing either softer, warm ambient glows or aggressive, brighter tones.

FEATURES

- Integrated frosted diffuser
- High-performance, high-quality manufacturing
- IP65 outdoor (wet) rated, water resistant
- Multiple CCT options available
- Dimmable
- Environment friendly, energy efficient light source

SPECIFICATIONS

INPUT VOLTAGE	24V DC Constant Voltage
POWER CONSUMPTION	4.4W per ft.
LUMEN OUTPUT	380 Lumens per Ft.
BEAM ANGLE	120°
CRI	85+
DIMMING	Compatible with most CL dimmers
MAXIMUM RUN LENGTH	32 Ft.
IP RATING	IP65 wet location (outdoor rated)
LUMEN MAINTENANCE	50,000 Hours
MOUNTING	Aluminum & PVC Mounting Channel (sold separately)
OPERATING TEMPERATURE	-4°F ~ 122°F (-20°C ~ 50°C)
STORAGE TEMPERATURE	-4°F ~ 176°F (-20°C ~ 80°C)
FIELD CUTTABLE	NO
CERTIFICATIONS	UL Listed
DIMENSIONS	Width x Depth: 0.61" x 0.23"

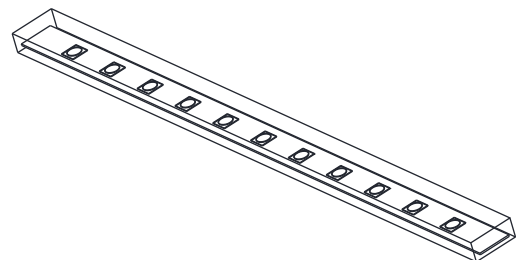
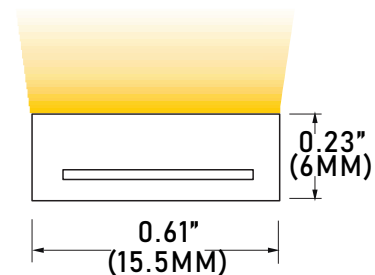

LSRN50 SERIES

4.4W IP65 Outdoor LED Strip

STANDARD ORDERING GUIDE

Model	Color Temperature	Length	Voltage	Power
LSRN50	27K 2700K	16 16.4 ft.	24 24 Volts	HW36 36" Power Feed
	30K 3000K	32 32 ft.		HW120 120" Power Feed
	35K 3500K	*PF per ft.	HW200 200" Power Feed	
	40K 4000K			
	50K 5000K			
	RGB RGB			

LSRN50 SERIES

4.4W IP65 Outdoor LED Strip

Accessories

LSRN40-AC2
2" Aluminum Channel



LSRN40-AC39
39" Aluminum Channel

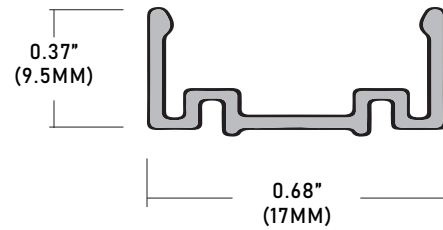

Hardwire Connector Kit

LSRN-HW36
36" Hardwire Power Feed
LSRN-HW120
120" Hardwire Power Feed
LSRN-HW200
200" Hardwire Power Feed

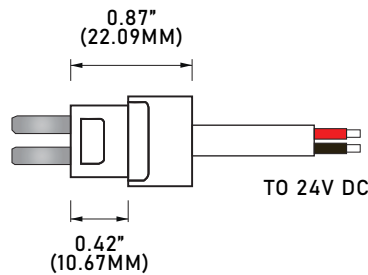

Interlink Cable Kit

LSRN-EX2
2" Link Cable
LSRN-EX6
6" Link Cable

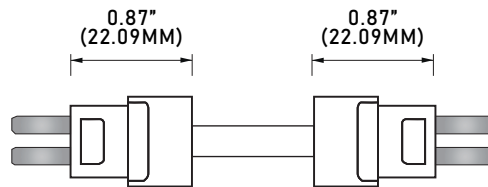

Seamless Coupling Kit

LSRN-MC
Mini-Coupling

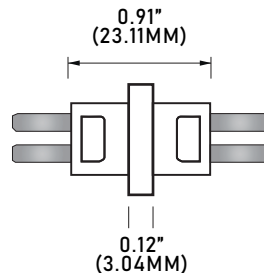

LSRN50 SERIES

4.4W IP65 Outdoor LED Strip

COMPATIBLE DRIVERS

PSDM SERIES

DIMMABLE MAGNETIC LOW VOLTAGE (MLV)

PSDM-20W-24V	CLASS 2	5.6" x 2" x 2.14"
PSDM-40W-24V	CLASS 2	5.6" x 2" x 2.14"
PSDM-60W-24V	CLASS 2	6.5" x 2.3" x 2.5"
PSDM-100W-24V	CLASS 2	6.5" x 2.3" x 2.5"
PSDM-150W-24V		9.8" x 3" x 3"
PSDM-192W-24V	CLASS 2	7.0" x 7.0" x 3.2"
PSDM-200W-24V		9.8" x 3" x 3"
PSDM-288W-24V	CLASS 2	9.8" x 4.2" x 3.5"
PSDM-300W-24V		7.0" x 7.0" x 3.2"

PSDH SERIES

HIGH PERFORMANCE MAGNETIC LOW VOLTAGE (MLV)

PSDH-48W-24V	CLASS 2	11.25" x 3.37" x 3.25"
PSDH-96W-24V	CLASS 2	11.25" x 3.37" x 3.25"
PSDH-288W-24V	CLASS 2	14.25" x 8.43" x 4.43"

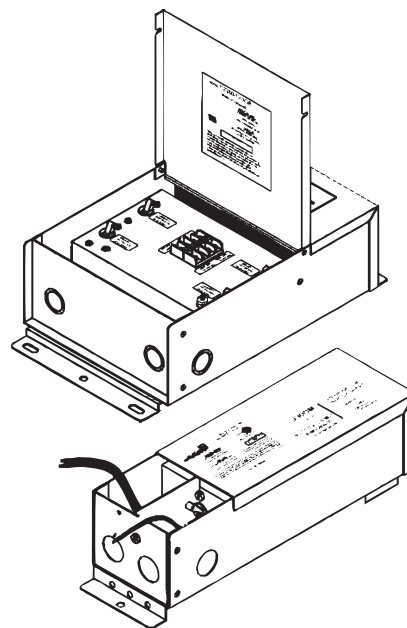
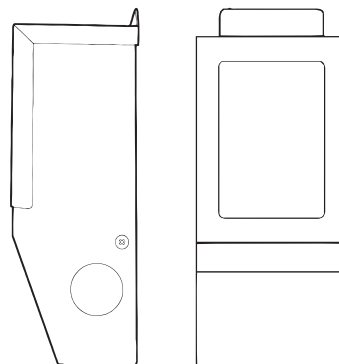

LSRN50 SERIES

4.4W IP65 Outdoor LED Strip

COMPATIBLE DRIVERS

PSDL SERIES

TRIAC DIMMABLE

PSDL-30W-24V	CLASS 2	6.5" x 3.63" x 1.03"
PSDL-60W-24V	CLASS 2	7.4" x 3.63" x 1.03"
PSDL-96W-24V	CLASS 2	8.67" x 3.67" x 1.62"
PSDL-150W-24V		8.67" x 3.67" x 1.62"
PSDL-192W-24V	CLASS 2	10.25" x 4.06" x 1.82"
PSDL-200W-24V		10.25" x 4.06" x 1.82"
PSDL-288W-24V	CLASS 2	10.25" x 4.06" x 1.82"
PSDL-300W-24V		10.25" x 4.06" x 1.82"

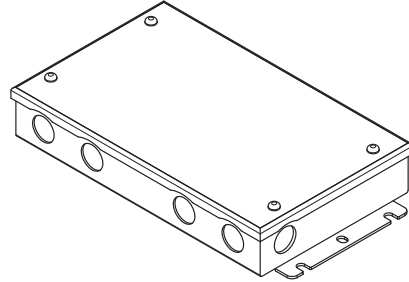

PSHK SERIES

NON-DIMMING W/ JUNCTION BOX

PSHK-30W-24V-UNV	CLASS 2	6.5" X 3.6" X 1.02"
PSHK-60W-24V-UNV	CLASS 2	7.4" X 3.62" X 1.02"
PSHK-96W-24V-UNV	CLASS 2	8.66" X 3.66" X 1.61"
PSHK-150W-24V-UNV		10.24" X 4.06" X 1.81"
PSHK-200W-24V-UNV		10.24" X 4.06" X 1.81"
PSHK-300W-24V-UNV		10.94" X 4.25" X 1.81"

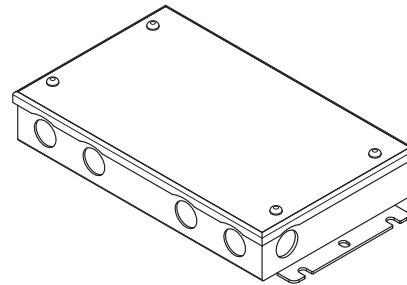

PSVT SERIES

0-10V DIMMING DRIVER

PSVT-60W-24V	CLASS 2	7.4" X 3.72" X 1.57"
PSVT-96W-24V	CLASS 2	8.66" X 3.72" x 1.57"
PSVT-200W-24V		10.24" X 4.13" x 1.77"
PSVT-288W-24V	CLASS 2	11.85" X 4.25" x 1.81"
PSVT-300W-24V	CLASS 2	10.94" X 4.33" x 1.77"

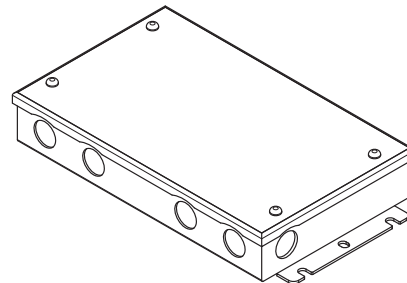

LSRN50 SERIES

4.4W IP65 Outdoor LED Strip

COMPATIBLE DRIVERS

PSRX SERIES

4-in-1 DIMMING DRIVER W/ JUNCTION BOX

PSRX-30W-24V-UNV	CLASS 2	6.5" X 3.7" X 1.57"
PSRX-60W-24V-UNV	CLASS 2	7.4" X 3.72" X 1.57"
PSRX-96W-24V-UNV	CLASS 2	10.24" X 4.13" X 1.77"
PSRX-150W-24V-UNV		10.24" X 4.13" X 1.77"
PSRX-200W-24V-UNV		10.24" X 4.13" X 1.77"
PSRX-300W-24V-UNV		10.94" X 4.33" X 1.77"

LUTRON 1%

2 OR 3-WIRE DIMMING

LTEA4U1UKL-CV240	CLASS 2	4.0" x 1.5" x 4.0"
L3DA4U1UKL-CV240	CLASS 2	4.0" x 1.5" x 4.0"

LUTRON 1%

PSDE-96W-24V-ECO	CLASS 2	10.5" x 3.0" x 2.0"
-------------------------	---------	---------------------

