

LSRN40 SERIES

3.8W IP65/IP67 Outdoor LED Strip



The LSRN series outdoor LED strip is a high-performance, water resistant light source designed for all-weather and harsh environments. It is manufactured with a patented epoxy PVC material that makes it resistant to salt water, chlorine, rain and humidity. Aside from its ability to withstand harsh environments, the LSRN series also does a great job of giving a space a much needed visual upgrade by providing either softer, warm ambient glows or aggressive, brighter tones.

FEATURES

- Integrated frosted diffuser
- High-performance, high-quality manufacturing
- IP65/IP67 outdoor (wet) rated, water resistant
- Multiple CCT options available
- Dimmable
- Environment friendly, energy efficient light source

SPECIFICATIONS

INPUT VOLTAGE	24V DC Constant Voltage
POWER CONSUMPTION	3.8W per ft.
LUMEN OUTPUT	140 Lumens per Ft.
BEAM ANGLE	120°
CRI	90
DIMMING	MLV, ELV, 0-10 and TRIAC
MAXIMUM RUN LENGTH	32 Ft.
IP RATING	IP65/IP67
LUMEN MAINTENANCE	50,000 Hours
MOUNTING	Aluminum & PVC Mounting Channel (sold separately)
OPERATING TEMPERATURE	-4°F ~ 122°F (-20°C ~ 50°C)
STORAGE TEMPERATURE	-4°F ~ 176°F (-20°C ~ 80°C)
CUTTING LENGTH	Every 3.3" (83.82MM)
CERTIFICATIONS	UL Listed
DIMENSIONS	Width x Depth: 0.50" x 0.22"

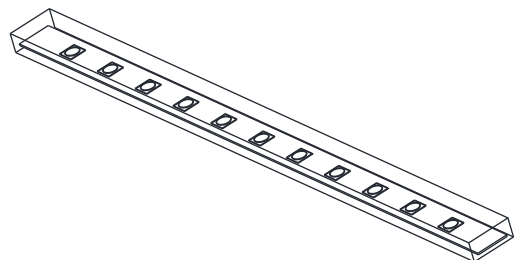
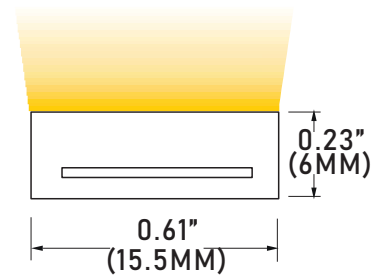

LSRN40 SERIES

3.8W IP65/IP67 Outdoor LED Strip

STANDARD ORDERING GUIDE

Model	Color Temperature	Length	Voltage	Power Feed	Power Feed Length
LSRN40	27K 2700K	16 16.4 ft.	24 24 Volts	IP65BF Bottom Feed	HW3 3 Ft. Power Feed
	30K 3000K	32 32 ft		IP65SFL Side Feed Left	HW10 10 Ft. Power Feed
	40K 4000K	*PF per ft.		IP65SFR Side Feed Right	
				IP65EF End Feed	
				IP67BF Bottom Feed	
				IP67SFL Side Feed Left	
				IP67SFR Side Feed Right	
				IP67EF End Feed	

* custom length orders come in increments of 3.3 inches.

LSRN40 SERIES

3.8W IP65/IP67 Outdoor LED Strip

IP65/IP67 power feed

BF
Bottom Feed

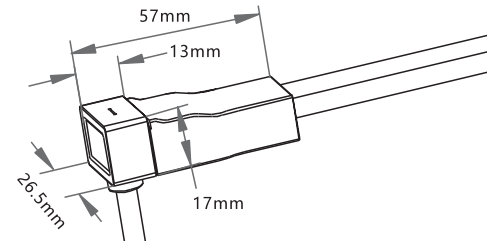

SFL
Side Feed Left

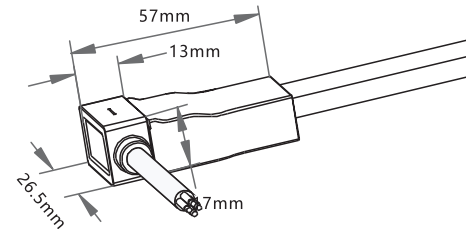

SFR
Side Feed Right

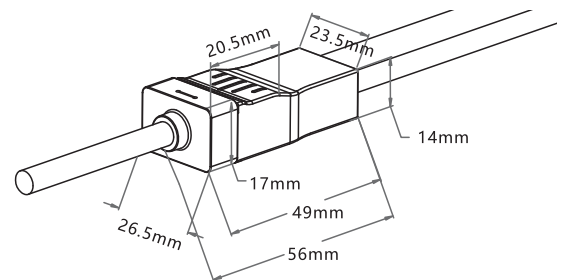

EF
End Feed



EC
End Cap

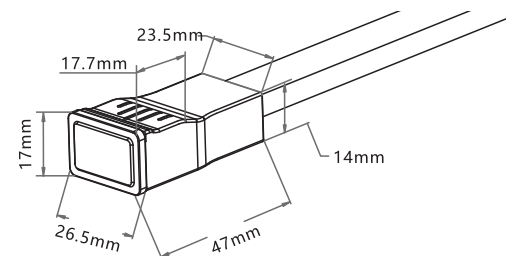

LSRN40 SERIES

3.8W IP65/IP67 Outdoor LED Strip

Accessories

LSRN40-AC2
2" Aluminum Channel



LSRN40-AC39
39" Aluminum Channel

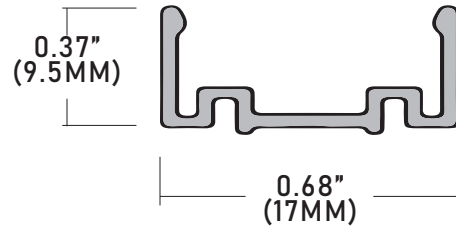

Bend Radius

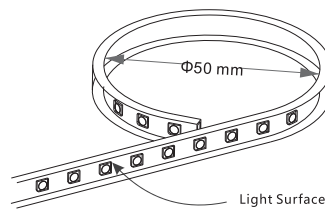

The light can only be bent along the light surface.

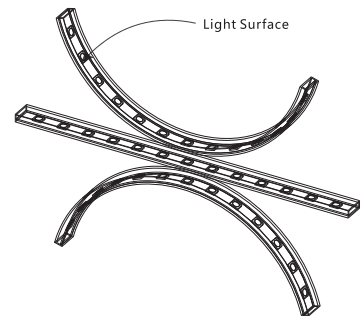

Do not bend smaller than allowed minimum bend diameter.

LSRN40 SERIES

3.8W IP65/IP67 Outdoor LED Strip

COMPATIBLE DRIVERS

PSDM SERIES

DIMMABLE MAGNETIC LOW VOLTAGE (MLV)

PSDM-20W-24V	CLASS 2	5.6" x 2" x 2.14"
PSDM-40W-24V	CLASS 2	5.6" x 2" x 2.14"
PSDM-60W-24V	CLASS 2	6.5" x 2.3" x 2.5"
PSDM-100W-24V	CLASS 2	6.5" x 2.3" x 2.5"
PSDM-150W-24V		9.8" x 3" x 3"
PSDM-192W-24V	CLASS 2	7.0" x 7.0" x 3.2"
PSDM-200W-24V		9.8" x 3" x 3"
PSDM-288W-24V	CLASS 2	9.8" x 4.2" x 3.5"
PSDM-300W-24V		7.0" x 7.0" x 3.2"

PSDH SERIES

HIGH PERFORMANCE MAGNETIC LOW VOLTAGE (MLV)

PSDH-48W-24V	CLASS 2	11.25" x 3.37" x 3.25"
PSDH-96W-24V	CLASS 2	11.25" x 3.37" x 3.25"
PSDH-288W-24V	CLASS 2	14.25" x 8.43" x 4.43"

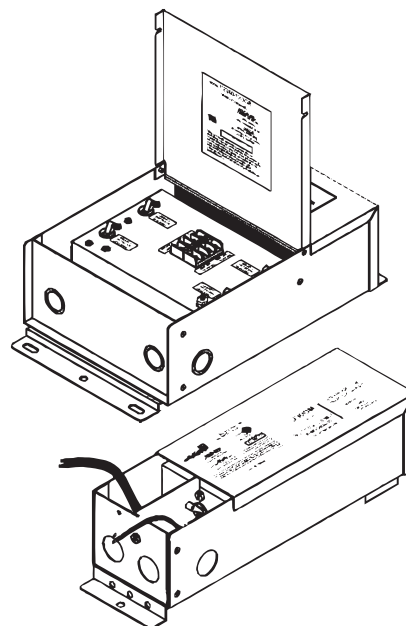
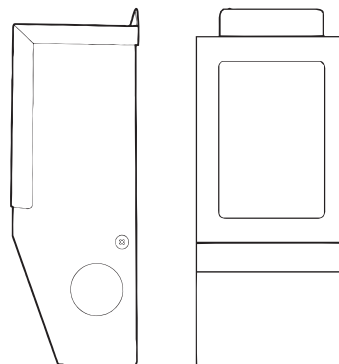

LSRN40 SERIES

3.8W IP65/IP67 Outdoor LED Strip

COMPATIBLE DRIVERS

PSDL SERIES
TRIAC DIMMABLE

PSDL-30W-24V	CLASS 2	6.5" x 3.63" x 1.03"
PSDL-60W-24V	CLASS 2	7.4" x 3.63" x 1.03"
PSDL-96W-24V	CLASS 2	8.67" x 3.67" x 1.62"
PSDL-150W-24V		8.67" x 3.67" x 1.62"
PSDL-192W-24V	CLASS 2	10.25" x 4.06" x 1.82"
PSDL-200W-24V		10.25" x 4.06" x 1.82"
PSDL-288W-24V	CLASS 2	10.25" x 4.06" x 1.82"
PSDL-300W-24V		10.25" x 4.06" x 1.82"

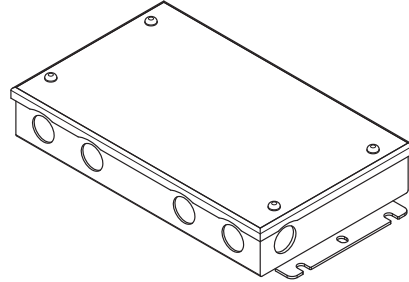

PSHK SERIES
NON-DIMMING W/ JUNCTION BOX

PSHK-30W-24V-UNV	CLASS 2	6.5" X 3.6" X 1.02"
PSHK-60W-24V-UNV	CLASS 2	7.4" X 3.62" X 1.02"
PSHK-96W-24V-UNV	CLASS 2	8.66" X 3.66" X 1.61"
PSHK-150W-24V-UNV		10.24" X 4.06" X 1.81"
PSHK-200W-24V-UNV		10.24" X 4.06" X 1.81"
PSHK-300W-24V-UNV		10.94" X 4.25" X 1.81"

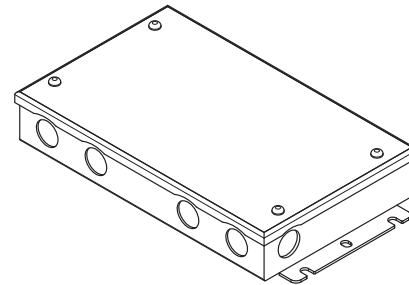

PSVT SERIES
0-10V DIMMING DRIVER

PSVT-60W-24V	CLASS 2	7.4" X 3.72" X 1.57"
PSVT-96W-24V	CLASS 2	8.66" X 3.72" x 1.57"
PSVT-200W-24V		10.24" X 4.13" x 1.77"
PSVT-288W-24V	CLASS 2	11.85" X 4.25" x 1.81"
PSVT-300W-24V	CLASS 2	10.94" X 4.33" x 1.77"

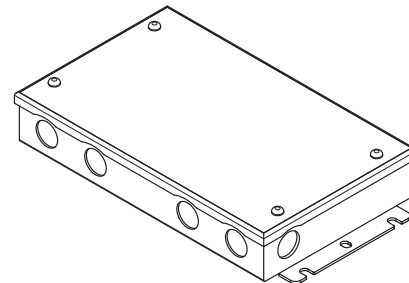

LSRN40 SERIES

3.8W IP65/IP67 Outdoor LED Strip

COMPATIBLE DRIVERS

PSRX SERIES

4-in-1 DIMMING DRIVER W/ JUNCTION BOX

PSRX-30W-24V-UNV	CLASS 2	6.5" X 3.7" X 1.57"
PSRX-60W-24V-UNV	CLASS 2	7.4" X 3.72" X 1.57"
PSRX-96W-24V-UNV	CLASS 2	10.24" X 4.13" X 1.77"
PSRX-150W-24V-UNV		10.24" X 4.13" X 1.77"
PSRX-200W-24V-UNV		10.24" X 4.13" X 1.77"
PSRX-300W-24V-UNV		10.94" X 4.33" X 1.77"

LUTRON 1%

2 OR 3-WIRE DIMMING

LTEA4U1UKL-CV240	CLASS 2	4.0" x 1.5" x 4.0"
L3DA4U1UKL-CV240	CLASS 2	4.0" x 1.5" x 4.0"

LUTRON 1%

PSDE-96W-24V-ECO	CLASS 2	10.5" x 3.0" x 2.0"
-------------------------	---------	---------------------

