

# PSDM-40W-12V 40W 12V Class 2 Constant Voltage Dimmable Driver



## SPECIFICATION SHEET

JOB NAME: \_\_\_\_\_  
 LOCATION: \_\_\_\_\_  
 QUOTE/REF#: \_\_\_\_\_

**PSDM-40W-12V** is a constant voltage Class 2 LED driver equipped with a magnetic transformer core. It features built-in protection for both the load and the driver via auto-reset breakers (one on the input and one on the output). Its durable, coated metal box includes 2 knock-outs, one on each side, for easy installation that complies with electrical code standards. Compatible with any standard MLV/incandescent TRIAC (leading edge) dimmer switch.

### FEATURES

- 40W 12V
- CLASS 2
- Dimmable
- NEMA 3R - outdoor use
- Suitable for Indoor or Outdoor Use
- Two knock-outs, one on each side
- Auto-Reset Feature



### INPUT SPECIFICATIONS

INPUT VOLTAGE	120 VAC
INPUT CURRENT @ MAX LOAD	0.51A
POWER FACTOR	> 0.88
EFFICIENCY	> 79%

### OUTPUT SPECIFICATIONS

MAX LOAD	40W
OUTPUT VOLTAGE	11.7 VDC @ full load
OUTPUT CURRENT @ MAX LOAD	3.96A
OPEN CIRCUIT OUTPUT VOLTAGE	12.8 VDC
COIL FORMER	Double Section Bobbin

### ENVIRONMENT SPECIFICATIONS

OPERATING TEMPERATURE	-30°C ~ 45°C (-22°F ~ 113°F)
MIN INSTALLATION SPACE BET DRIVERS	5"
THERMAL CLASS	B130°C

### SAFETY PROTECTION SPECIFICATIONS

CIRCUIT BREAKER	Primary and secondary auto-reset feature
-----------------	--

### MECHANICAL/HOUSING SPECIFICATIONS

LEADS PRIMARY	PVC 600V #20
LEADS SECONDARY	PVC 300V #16
LENGTH	5.6" (142.2mm)
WIDTH	2.14" (54.3mm)
HEIGHT	2" (50.8mm)
WEIGHT	35oz (990 grams)
HOUSING MATERIAL	coated metal
HOUSING COLOR	Black
JUNCTION BOX	yes
MOUNTING	two-hole flange mounting

### WIRING DIAGRAM

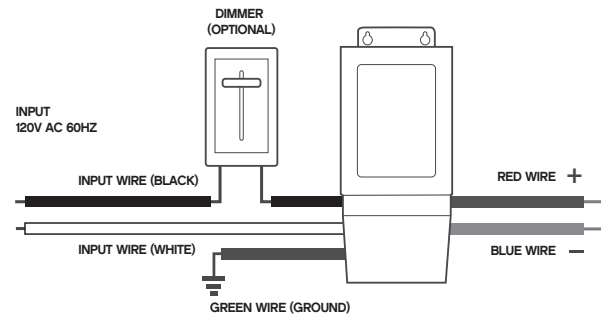

## DIAGRAM AND DIMENSIONS

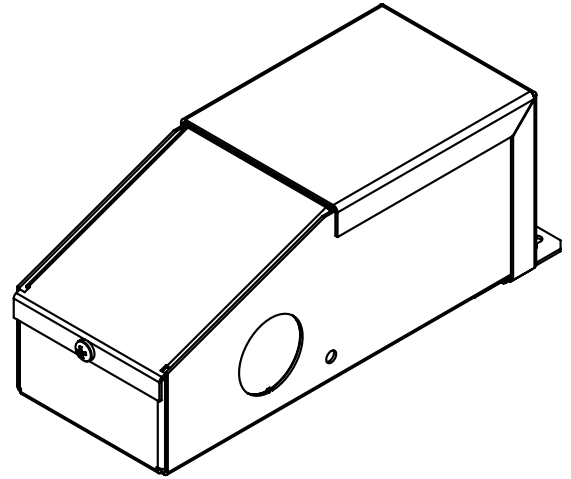
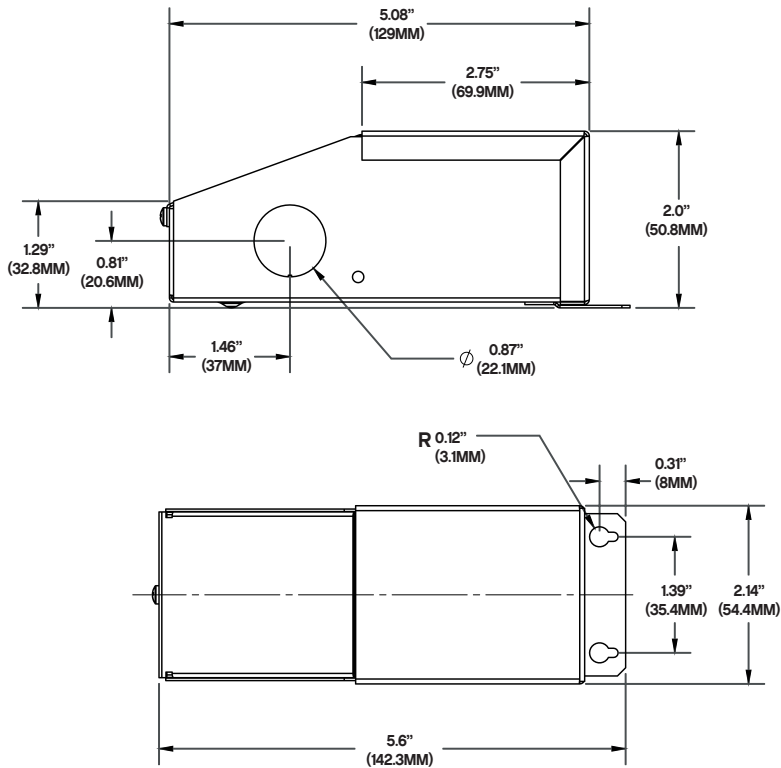

## INSTALLATION GUIDE



**THIS TRANSFORMER IS ONLY TO BE INSTALLED BY A QUALIFIED TECHNICIAN IN ACCORDANCE WITH NATIONAL AND LOCAL ELECTRICAL CODES**

### BEFORE YOU BEGIN

Make sure the transformer has the proper input voltage and wattage for the intended job. Check wiring and make sure they match the diagram on this guide.

### MOUNTING

Select a suitable and proper location to mount the driver. Consider the weight of the driver to be supported.

### INPUT CONNECTIONS / GROUNDING

1. Remove input wiring cover and install strain reliefs.
2. Make sure power is turned off. Route input wires and make connections based on wiring diagram following the INPUT side.
3. Make sure that driver is properly grounded in accordance with the N.E.C.

### OUTPUT CONNECTIONS

1. Remove output wiring cover and install clamp connectors.
2. Make sure power is turned off. Route fixture wires and make connections based on wiring diagram following the OUTPUT side.

