

SPECIFICATION SHEET

JOB NAME: _____
 LOCATION: _____
 QUOTE/REF#: _____

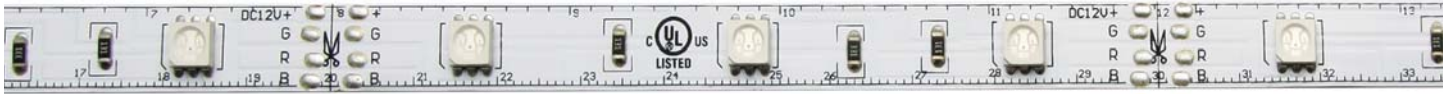

LSP80RGB is a Color changing flexible LED strip that provides a full spectrum of color options using red, green and blue LED technology. The countless color mixing possibilities make RGB LEDs a diverse choice for even the most discerning in lighting solutions and applications. It can be easily installed onto most mounting surfaces with double sided mounting tapes.

SPECIFICATIONS

INPUT VOLTAGE	24V DC constant voltage
POWER CONSUMPTION	8.8W per ft.
LUMEN OUTPUT	720 Lumens per ft.
NO. OF LEDs	36 LEDs per ft.
BEAM ANGLE	120°
CRI	90°
DIMMING	Through RGB controller
MAXIMUM RUN LENGTH	20 ft.
FIELD CUTTABLE	every 2"
IP RATING	IP45 (indoor/dry), IP65 (outdoor/wet)
LUMEN MAINTENANCE	50,000 Hrs
CERTIFICATIONS	UL Listed, TITLE 24
DIMENSIONS	Width x Depth: 0.78" x 0.15"

FEATURES

- Superior Color Rendering Index (CRI)
- Up to 20 ft. of continuous linear light
- Field cuttable
- Architectural grade LED lighting
- Suitable for accent or ambient lighting

RGB COLOR SPECTRUM



CUTTABLE EVERY 1"

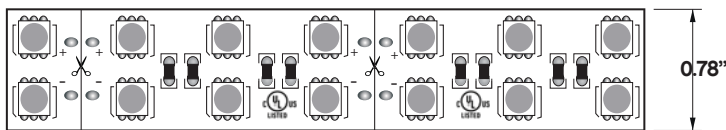

ORDERING GUIDE

SERIES	MODEL	LENGTH	VOLTAGE
LSP - Indoor	80GRB	16 - 16.4 FT. 100 - 100 FT. PF - PER FT. (12")	24 - 24V DC

COMPATIBLE CHANNELS

*Custom Finish Available

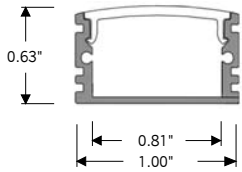

ALU-DS100 | SURFACE MOUNT

LENGTHS	39 ^{3/8} " and 78 ^{7/8} "
LENS	Clear & Frosted
FINISH	Anodized Silver

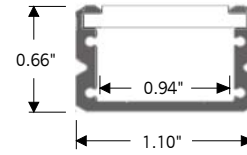

ALP-90 | SURFACE MOUNT

LENGTHS	48" and 96"
LENS	Clear & Frosted
FINISH	Anodized Silver

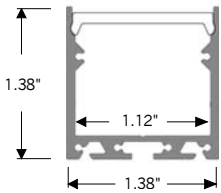

ALP-140 | SURFACE OR SUSPENDED MOUNT

LENGTHS	49.25" and 98.5"
LENS	Frosted
FINISH	Anodized Silver

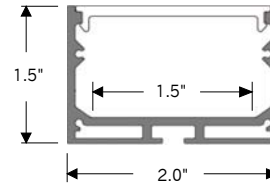

ALP-160 | SURFACE OR SUSPENDED MOUNT

LENGTHS	49.25" and 98.5"
LENS	Frosted
FINISH	Anodized Silver

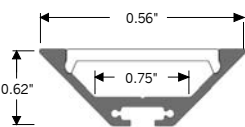

ALP-190 | SURFACE OR SUSPENDED MOUNT

LENGTHS	49.25" and 98.5"
LENS	Frosted
FINISH	Anodized Silver

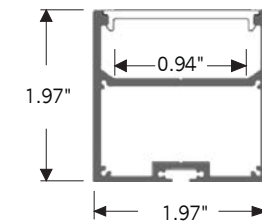

ALP-200 | SURFACE OR SUSPENDED MOUNT

LENGTHS	49.25" and 98.5"
LENS	Frosted
FINISH	Anodized Silver

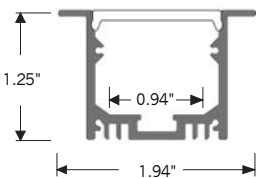

ALP-200R | RECESSED MOUNT

LENGTHS	49.25" and 98.5"
LENS	Frosted
FINISH	Anodized Silver

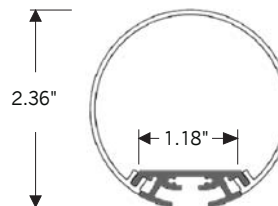

ALP-245 | SUSPENDED MOUNT

LENGTHS	49.25 and 98.5"
LENS	Frosted
FINISH	Anodized Silver

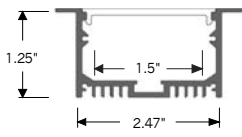

ALP-250R | RECESSED MOUNT

LENGTHS	49.25" and 98.5"
LENS	Frosted
FINISH	Anodized Silver

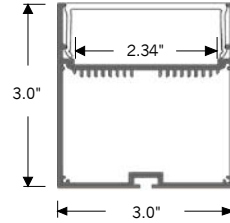

ALP-300 | SURFACE MOUNT

LENGTHS	49.25" and 98.5"
LENS	Frosted
FINISH	Anodized Silver

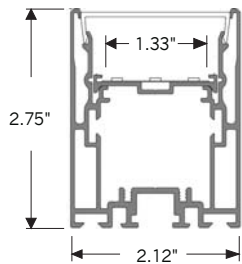

ALP-230N | SURFACE, SUSPENDED MOUNT

LENGTHS	49.25" and 98.5"
LENS	Frosted
FINISH	Anodized Silver

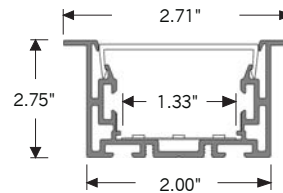

ALP-230RN | RECESSED MOUNT

LENGTHS	49.25 and 98.5"
LENS	Frosted
FINISH	Anodized Silver

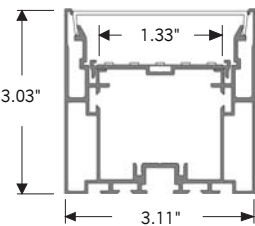

ALP-310N | SURFACE OR SUSPENDED MOUNT

LENGTHS	48" and 96"
LENS	Frosted
FINISH	Anodized Silver

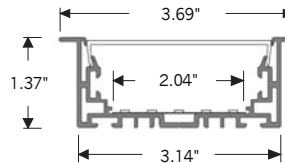

ALP-330RN | RECESSED MOUNT

LENGTHS	48" and 96"
LENS	Frosted
FINISH	Anodized Silver



LSP-80RGB 8.8W Color Changing Indoor LED Strip

COMPATIBLE RGB CONTROLLERS

TOUCH SERIES		
RGB-CT330	RECEIVING CONTROLLER INPUT 12V - 24V DC MAX OUTPUT CURRENT 3A X 3CH MAX OUTPUT POWER 108W(12V), 216W (24V) WORKING TEMP -30°C ~ 55°C WEIGHT (gross) 135g	RECEIVER
	HANDHELD REMOTE INPUT VOLTAGE 3V (CR2032 battery) WORKING FREQUENCY 433.92MHz REMOTE DISTANCE 90ft. WORKING TEMP -30°C ~ 55°C WEIGHT (gross) 42g	
RGB-CT400	RECEIVING CONTROLLER INPUT 12V - 24V DC MAX OUTPUT CURRENT 5A X 3CH, 15A Max MAX OUTPUT POWER 180W(12V), 360W (24V) CONTROL BUTTON 8 touch button WORKING TEMP -30°C ~ 55°C WEIGHT (gross) 180g	
	HANDHELD REMOTE INPUT VOLTAGE 5V DC (Built-in Lithium battery) WORKING CURRENT <30mA WORKING FREQUENCY 2.4GHz REMOTE DISTANCE 90ft. CHANGE MODE 32 modes WEIGHT (gross) 200g	

LSP-80RGB 8.8W Color Changing Indoor LED Strip

COMPATIBLE RGB CONTROLLERS

WALL CONTROLLERS

RGB-CT600

INPUT VOLTAGE	5V DC, 1A
OUTPUT SIGNAL	RF 2.4GHz + DMX512
CONTROL	4 ZONES
WORKING TEMP	-30°C ~ 55°C
WEIGHT (gross)	370g

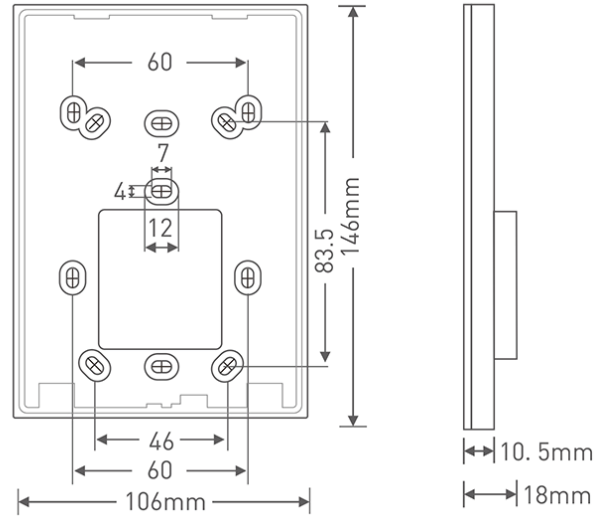

RGB-SDE3

INPUT POWER	6V DC 0.6A
OUTPUT SIGNAL	DMX512 (x2)
PROGRAMMABILITY	PC, MAC, Tablet, Smartphone
AVAILABLE COLORS	Black / White
CONNECTIONS	USB, Ethernet, RS232, Clock, 8dry contact ports, 5V output relay
MEMORY	microSD card
WORKING TEMP	-10°C ~ 45°C
MOUNTING	Single or double gang wall socket
WEIGHT (gross)	247g

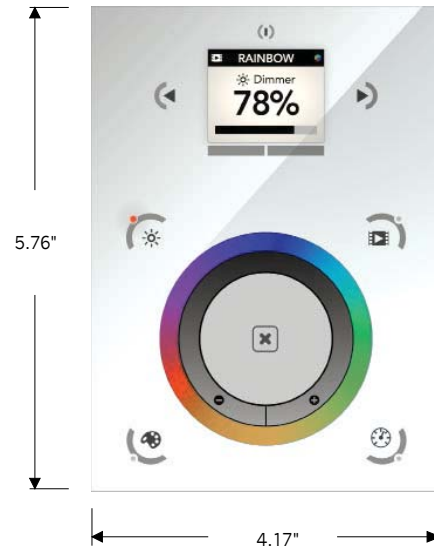

LSP-80RGB 8.8W Color Changing Indoor LED Strip

COMPATIBLE RGB CONTROLLERS

DMX SERIES

RGB-DMX4C

INPUT	12V - 24V DC
OUTPUT CURRENT	8A X 4CH
OUTPUT POWER	240W(12V), 720W (24V)
OUTPUT CHANNELS	3 or 4 selectable

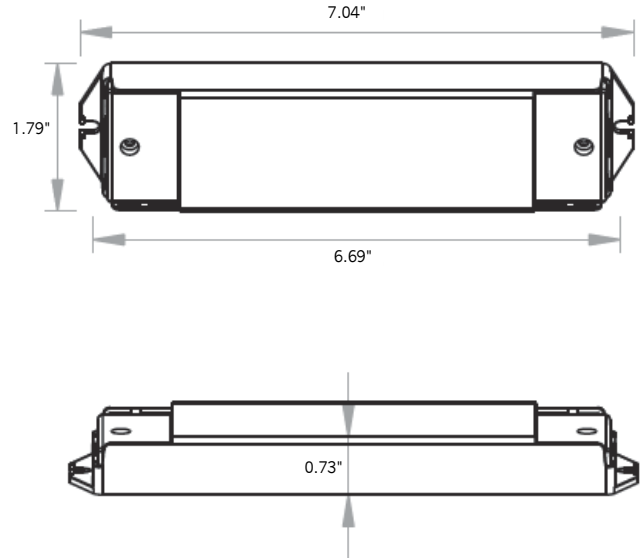

RGB-DMX5C-XLR

INPUT	12V-24V-36V DC
OUTPUT CURRENT	8A X 5CH

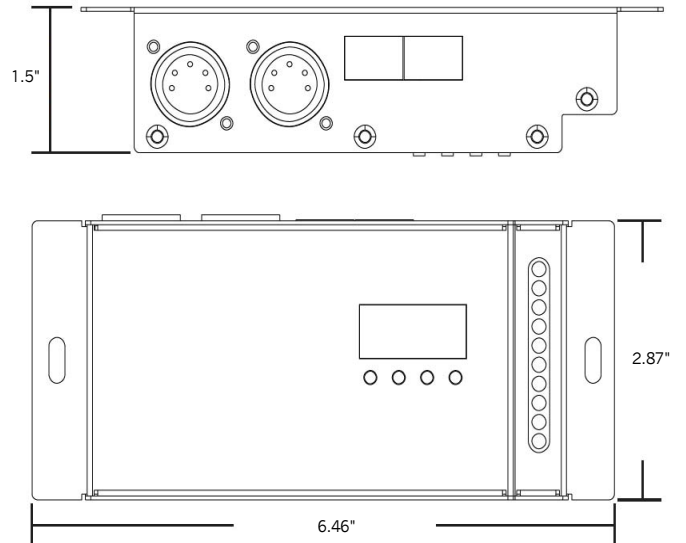

LSP-80RGB 8.8W Color Changing Indoor LED Strip

COMPATIBLE NON-DIMMING TRANSFORMERS

HARDWIRE CONSTANT VOLTAGE

		CLASS 2	L X W X H
PSHW SERIES 12V	PSHW-10W-12V	YES	2.55" X 1.37" X .90"
	PSHW-20W-12V	YES	4.64" X 1.38" X 1.2"
	PSHW-35W-12V	YES	5.83" X 1.57" X 1.18"
	PSHW-60W-12V	YES	6.38" X 1.65" X 1.18"
	PSHW-100W-12V	NO	7.44" X 2.4" X 1.45"
	PSHW-150W-12V	NO	8.75" X 2.68" X 1.53"
	PSHW-200W-12V	NO	9.62" X 2.68" X 1.53"
	PSHW-300W-12V	NO	9.92" X 3.55" X 1.75"

		CLASS 2	L X W X H
PSHW SERIES 24V	PSHW-10W-24V	YES	2.55" X 1.37" X .90"
	PSHW-20W-24V	YES	4.64" X 1.38" X 1.2"
	PSHW-35W-24V	YES	5.83" X 1.57" X 1.18"
	PSHW-60W-24V	YES	6.38" X 1.65" X 1.18"
	PSHW-100W-24V	NO	7.44" X 2.4" X 1.45"
	PSHW-150W-24V	NO	8.75" X 2.68" X 1.53"
	PSHW-200W-24V	NO	9.62" X 2.68" X 1.53"
	PSHW-300W-24V	NO	9.92" X 3.55" X 1.75"

